

Low Impact Development

Technical Guidance Manual for Puget Sound



December 2012

WASHINGTON STATE UNIVERSITY
 EXTENSION

PugetSoundPartnership

LEADING PUGET SOUND RECOVERY

THIS PAGE
INTENTIONALLY
LEFT BLANK

Low Impact Development

Technical Guidance Manual for Puget Sound

December 2012



WSU Puyallup Research
& Extension Center
2606 West Pioneer
Puyallup, WA 98371
www.pierce.wsu.edu



LEADING PUGET SOUND RECOVERY

326 East D Street
Tacoma, WA 98421
360.464.1232
info@psp.wa.gov

Author and project co-lead: Curtis Hinman, Washington State University Extension Faculty

Project co-lead: Bruce Wulkan, Puget Sound Partnership

Design and layout: AHBL

Illustrations: AHBL (except where noted)

Research, facilitation and external review: VEDA Consulting

THIS PAGE
INTENTIONALLY
LEFT BLANK

Acknowledgements

Technical Advisory Committee

Bruce Barker	MGS
Catherine Benotto	Webber Thompson
Mark Buehrer	2020 Engineers
Art Castle	Building Industry Association of WA
Rich Geiger	Mason Conservation District
Kathy Gwilym	SvR Design
Kas Kinhead	Cascade Design Collaborative
Tim Kurtz	City of Portland
Alice Lancaster	Herrera
Chris May	Kitsap County
David McDonald	City of Seattle
Matt Miller	Associated Earth Sciences
Ed O'Brien	Department of Ecology
Tracy Tackett	City of Seattle
Bruce Wulkan	Puget Sound Partnership
Craig Young	Snohomish County

Contributors

Michael Bledsoe	Pervious Concrete Inc.
Patrick Carey	Hadj Designs
Jeff Cox	Triad Associates
Drena Donofrio	Seattle Public Utilities
Rick Gagliano	PIN Foundations
Erica Guttman	Washington State University Extension
Robin Kirschbaum	HDR
Andy Marks	Puget Sound Concrete Specification Council
David McDonald	Seattle Public Utilities
Ed O'Brien	Department of Ecology
Robert Pine	Pine and Swallow Environmental
David Smith	Interlocking Concrete Pavement Institute
Paul Thompson	Urban Forestry Services, Inc.
Brian Taylor	AMEC

Funding

Portions of this project were produced with support from the Puget Sound Partnership. Washington State University Extension contributed in-kind support for this project.

THIS PAGE
INTENTIONALLY
LEFT BLANK

Table of Contents

Glossary.....	i
1. Introduction.....	1
1.1 Puget Sound Hydrology.....	2
1.2 Impacts of Urbanization.....	2
1.3 Current Stormwater Management.....	9
1.4 Low Impact Development.....	10
2. Site Assessment.....	17
2.1 Stormwater Site Plans.....	18
2.2 Soil and Subsurface Hydrology Characterization.....	22
2.3 Hydrologic Patterns and Features.....	27
2.4 Native Forest and Soil Protection Areas.....	27
2.5 Wetlands.....	28
2.6 Riparian Management Areas (RMA).....	29
2.7 Streams.....	30
2.8 Floodplains.....	30
2.9 Sub-basin Delineation.....	31
2.10 Site Mapping Process.....	32
3. Site Planning & Layout.....	35
3.1 Urban Redevelopment and Infill.....	37
3.2 New Suburban Development.....	47
3.3 Commercial Development.....	69
3.4 Road Crossings.....	72
4. Vegetation & Soil Protection & Reforestation.....	73
4.1 Native Vegetation and Soil Protection.....	75
4.2 Re-establishing Native Vegetation.....	80
4.3 Maintenance of Protected Areas.....	82
5. Precision Site Preparation, Construction & Inspection of LID Facilities.....	83
5.1 Precision Site Preparation.....	84
5.2 Techniques to Minimize Site Disturbance.....	86
5.3 Inspection of LID Facilities.....	86
5.4 Construction Sequencing of LID Facilities.....	90

Table of Contents, cont.

6. Integrated Management Practices.....	97
6.1 Bioretention.....	98
6.2 Amending Construction Site Soils.....	149
6.3 Permeable Pavement.....	161
6.4 Urban and Suburban Trees.....	203
6.5 Vegetated Roofs.....	217
6.6 Minimal Excavation Foundation Systems.....	227
6.7 Roof Rainwater Collection Systems.....	233
7. Washington State Department of Ecology Low Impact Development Design & Flow Modeling Guidance.....	243
PART 1: GUIDANCE FOR MODELING WITH THE CURRENT WWHM 3.....	244
7.1 Bioretention.....	244
7.2 Soil Quality and Depth.....	246
7.3 Permeable Pavement.....	246
7.4 Tree Retention and Planting.....	251
7.5 Vegetated Roofs.....	252
7.6 Minimal Excavation Foundations.....	253
7.7 Rainwater Harvesting.....	253
7.8 Dispersion.....	253
PART 2: SUMMARY OF WWHM 2012 REPRESENTATION OF LID PRACTICES.....	254
7.9 Bioretention.....	254
7.10 Post-Construction Soil Quality and Depth.....	255
7.11 Permeable Pavement.....	255
7.12 Newly Planted and Retained Trees.....	255
7.13 Vegetated Roofs.....	255
7.14 Minimal Excavation Foundations.....	255
7.15 Full Dispersion.....	255
7.16 Rainwater Harvesting.....	255
PART 3: LID SIZING TOOL FOR WESTERN WASHINGTON LOWLANDS (GSI-CALC).....	256
7.18 GSI-Calc Applicability.....	256
7.19 GSI-Calc Development.....	258
7.20 GSI BMPs and Design Requirements.....	259
7.21 Limitations and Future Updates.....	260

Table of Contents, cont.

Appendix 1 - Bioretention Plant List.....	261
Appendix 2 - Street Tree List.....	283
Appendix 3 - Laboratory Procedures for Determining Bioretention Soil Mix Saturated Hydraulic Conductivity.....	299
Appendix 4 - Maintenance of Low Impact Development Facilities.....	301
References.....	330

THIS PAGE
INTENTIONALLY
LEFT BLANK

Manual Intent

The purpose of this manual is to provide stormwater managers and site designers with a common understanding of LID goals, objectives, specifications for individual practices, and flow reduction and water quality treatment credits that are applicable to the Puget Sound region. In addition to the guidelines for specific practices, this manual provides research and data related to those practices to help managers and designers make informed decisions when adapting LID applications to their jurisdictions. Low impact development is a relatively new and evolving stormwater management approach; accordingly, this document will evolve and be periodically updated as additional research becomes available and professionals in the region gain more practical experience. This is a technical manual and the information provided is targeted for engineers, planners, landscape architects, technical staff to policy makers, and developers.

Manual Organization

Chapter one of the manual sets the context for the LID approach with an introduction to Puget Sound lowland hydrology and the effects of urban development on streams, wetlands, and Puget Sound. Chapter one also establishes the goals and objectives for LID in the context of the reissued municipal NPDES general stormwater permits for western Washington and aligns with the 2012 Stormwater Management Manual for Western Washington. Chapters on site assessment, planning and layout, vegetation protection, and precision clearing and grading follow chapter one and emphasize the importance of planning and protecting native vegetation and soils in the LID approach. Chapter six provides general guidance for seven integrated management practices (IMPs) as well as detailed construction and material specifications for many of the IMPs. Chapter seven provides the flow credits in the Western Washington Hydrology Model (or equivalent continuous simulation model) that will allow engineers to eliminate or reduce the size of conventional flow control facilities when using LID practices. Finally, several appendices include lists of plants appropriate for LID applications and guidelines for maintenance. Bolded words within the text of the manual are defined in the glossary of terms.

THIS PAGE
INTENTIONALLY
LEFT BLANK

Glossary

Advection:	The transfer or change of a property of the atmosphere (e.g., humidity) by the horizontal movement of a mass of fluid (e.g., air current).
Allelopathic:	The suppression of growth of one plant species as a result of the release of a toxic substance by another plant species.
Alluvium:	Unconsolidated clay, silt, sand, or gravel deposited by running water in the bed of a stream or on its flood plain.
Ammonification:	The process in which organic forms of nitrogen (e.g., nitrogen present in dead plant material compounds) are converted to ammonium (NH ₄ ⁺) by decomposing bacteria.
AASHTO H-20:	The load representing a truck used in design of highways and bridges. The basic design truck is a single unit weighing 40 kips. A kip (often called a kilopound) represents 1,000 pound-force. The subsequent HS20 designation represents higher loads typical of tractor-semi-trailer combinations.
Bankful discharge:	The stream discharge that fills the channel to the top of the banks and just begins to spread onto the floodplain. Bankful discharge occurs on average 1-1.5 years in undisturbed watersheds and is the flow that primarily controls the shape and form in natural channels.
Bedload:	Sediment particles that are transported as a result of shear stress created by flowing water, and which move along, and are in frequent contact with, the streambed.
Bioretention cells:	Shallow depressions accepting stormwater from small contributing areas with plants and a soil media designed to provide a specific saturated hydraulic conductivity and pollutant removal characteristics and support healthy plants. A variety of plants are used in bioretention areas, including trees, shrubs, grasses, and/or other herbaceous plants. Bioretention cells may or may not have an under-drain and are not designed as a conveyance system.
Bioretention swales:	Incorporate the same design features as bioretention cells; however, bioretention swales are designed as part of a conveyance system and have relatively gentle side slopes and flow depths that are generally less than 12 inches.
Biotic integrity:	The condition where the biologic or living community of an aquatic or terrestrial system is unimpaired and the compliment of species diversity and richness expected for that system is present.

Bole:	The trunk of a tree.
California Bearing Ratio:	A test using a plunger of a specific area to penetrate a soil sample to determine the load bearing strength of a road subgrade.
Crown projection:	The perimeter of a tree's crown (outer most extent of the branches and foliage) projected vertically to the ground.
Cation exchange capacity:	The amount of exchangeable cations that a soil can adsorb at pH 7.0 expressed in terms of milliequivalents per 100 grams of soil (me/100 g).
Compost maturity:	A term used to define the effect that compost has on plant growth. Mature compost will enhance plant growth; immature compost can inhibit plant growth.
Compost stability:	The level of microbial activity in compost that is measured by the amount of carbon dioxide produced by a sample in a sealed container over a given period of time.
Critical shear stress:	Lift and drag forces that move sediment particles. The forces are created as faster moving water flows past slower water.
Denitrification:	The reduction of nitrate (commonly by bacteria) to di-nitrogen gas.
Desorb:	To remove (a sorbed substance) by the reverse of adsorption or absorption.
Diurnal oxygen fluctuations:	The fluctuation in dissolved oxygen in water as photosynthetic activity increases during the day and decreases during the night.
Exfiltration:	The movement of soil water from an infiltration IMP to the surrounding soil.
Endocrine disruptors:	Substances that stop the production or block the transmission of hormones in the body.
Effective impervious area (EIA):	The subset of total impervious area that is hydrologically connected via sheet flow or discrete conveyance to a drainage system or receiving body of water. Washington State Department of Ecology considers impervious areas in residential development to be ineffective if the runoff is dispersed through at least 100 feet of native vegetation using approved dispersion techniques.
Evapotranspiration:	The collective term for the processes of water returning to the atmosphere via intercepted and evaporation from plant surfaces and transpiration through plant leaves.
Exudates:	Substances exuded from plant roots that can alter the chemical, physical and biological structure of the surrounding soil.
Friable:	The soil property of consistence describing the resistance of material to deformation or rupture. Consistence refers to the degree of cohesion or adhesion of the soil mass and is strongly affected by the moisture content of the soil. A friable soil is easily broken apart.

Gravimetric sampling:	Methods used the quantitative determination of an analyte based on the mass of a solid. Isolation of the analyte for measurement is usually achieved by precipitation, volatilization or drying.
Hydrologically functional landscape:	A term used to describe a design approach for the built environment that attempts to more closely mimic the overland and subsurface flow, infiltration, storage, evapotranspiration, and time of concentration characteristic of the native landscape of the area.
Hydroperiod:	The seasonal occurrence of flooding and/or soil saturation that encompasses the depth, frequency, duration, and seasonal pattern of inundation.
In-line bioretention facility:	A bioretention area that has a separate inlet and outlet.
Invert:	The lowest point on the inside of a sewer or other conduit.
Los Angeles (LA) Abrasion:	The standard L.A. abrasion test subjects a coarse aggregate sample (retained on the No. 12 or 1.70 mm sieve) to abrasion, impact, and grinding in a rotating steel drum containing a specified number of steel spheres. After being subjected to the rotating drum, the weight of aggregate that is retained on a No. 12 (1.70 mm) sieve is subtracted from the original weight to obtain a percentage of the total aggregate weight that has broken down and passed through the No. 12 (1.70 mm) sieve. Therefore, an L.A. abrasion loss value of 40 indicates that 40 percent of the original sample passed through the No. 12 (1.70 mm) sieve. The standard Los Angeles abrasion test is: AASHTO T 96 or ASTM C 131: Resistance to Degradation of Small-Size Coarse Aggregate by Abrasion and Impact in the Los Angeles Machine.
Liquefaction:	The temporary transformation of a soil mass of soil or sediment into a fluid mass. Liquefaction occurs when the cohesion of particles in the soil or sediment is lost.
Mycorrhizal:	The symbiotic association of the mycelium of a fungus with the roots of a seed plant.
Native Soil and vegetation protection areas:	Areas covered by vegetation that will not be subject to land disturbing activity or compaction (clearing, grading, storage, stockpiling, vehicles, etc.) that are fenced and continuously protected from impacts throughout the construction process and protected post-construction through zoning or other legal agreement.
Nitrification:	The process in which ammonium is converted to nitrite and then nitrate by specialized bacteria.
Off-line bioretention facility:	A bioretention area where water enters and exits through the same location.
Phytoremediation:	The utilization of vascular plants, algae and fungi to control, breakdown, or remove wastes, or to encourage degradation of contaminants in the rhizosphere (the region surrounding the root of the plant).

Potholing:	Excavating a hole in the ground to observe buried utilities or facilities. Potholes are typically excavated using a backhoe or by hand, depending on the environment.
Precision site preparation:	The process where mass clearing and grading (that increases the probability of high sediment loads released from the property, excessive soil compaction and sediment management expense) is replaced with more targeted clearing and grading and sequencing that protects native soils and vegetation, minimizes exposure soil and reduces soil compaction.
Rain Garden:	A non-engineered, shallow landscape depression with native soil or a soil mix and plants that is designed to capture stormwater from small, adjacent contributing areas.
Saturated hydraulic conductivity:	The ability of a fluid to flow through a porous medium under saturated conditions and is determined by the size and shape of the pore spaces in the medium and their degree of interconnection and also by the viscosity of the fluid. Hydraulic conductivity can be expressed as the volume of fluid that will move in unit time under a unit hydraulic gradient through a unit area measured at right angles to the direction of flow.
Seral stage:	Any stage of development or series of changes occurring in the ecological succession of an ecosystem or plant community from a disturbed, un-vegetated state to a climax plant community.
Soil stratigraphy:	The sequence, spacing, composition, and spatial distribution of sedimentary deposits and soil strata (layers).
Soil bulk density:	The ratio of the mass of a given soil sample to the bulk volume of the sample.
Stage excursions:	A post-development departure, either higher or lower, from the water depth existing under a given set of conditions in the pre-development state.
Stemflow:	The portion of precipitation falling on a tree (or other plant) that is intercepted by the foliage and branches and flows along the stems and trunk of the tree and to the ground.
Time of concentration:	The time that surface runoff takes to reach the outlet of a sub-basin or drainage area from the most hydraulically distant point in that drainage area.
Threshold discharge area:	An onsite area draining to a single natural discharge location or multiple natural discharge locations that combine within one-quarter mile downstream (as determined by the shortest flow path).
Throughfall:	The portion of precipitation that falls within the tree crown perimeter and falls to the ground without being intercepted by the foliage or branches or is intercepted and then drips from the foliage or branches to the ground.

Total impervious area (TIA):	The total area of surfaces on a developed site that inhibit infiltration of stormwater. The surfaces include, but are not limited to, conventional asphalt or concrete roads, driveways, parking lots, sidewalks or alleys, and rooftops.
Transmissivity:	A term that relates to movement of water through an aquifer. Transmissivity is equal to the product of the aquifer's permeability and thickness (m ² /sec).
Tree crown dripline:	The outer most perimeter of a tree crown defined on the ground by the dripping of water vertically from the leaves of tree canopy perimeter.

Commonly Used Acronyms

AASHTO:	American Association of State Highway and Transportation Officials
ASTM:	American Society for Testing and Materials
BSM	Bioretention Soil Media
CEC:	Cation Exchange Capacity
CRZ:	Critical Root Zone
IMPs:	Integrated Management Practices
Ksat:	Saturated Hydraulic Conductivity
OGFC:	Open Graded Friction Courses
PIT:	Pilot Infiltration Test
SBSS:	Sand-based Structural Soils
SWMMWW:	Stormwater Management Manual for Western Washington
TMECC:	Test Methods for Examination of Composting and Compost
WWHM:	Western Washington Hydrologic Model

Metric Equivalents

1 centimeter	0.39 inches
1 meter	39.37 inches
1 millimeter	0.039 inches
1 hectare	2.27 acres
1 liter	4.23 gallons
1 cubic meter	31.31 cubic feet

Introduction

1 CHAPTER

Puget Sound Hydrology	1.1
Current Stormwater Management	1.2
Impacts of Urbanization	1.3
Low Impact Development Definition	1.4
Low Impact Development Goals & Objectives	1.5
Low Impact Development in the Watershed Context	1.6

1.1 Puget Sound Hydrology

Native forests and prairies of the Puget Sound lowlands intercept, store, and slowly release and convey precipitation through complex pathways. Water budget studies of wet coniferous forests in western Washington, British Columbia, and the United Kingdom indicate that approximately 40 percent of the annual rainfall is intercepted by foliage and evaporated during the rainy season. Bauer and Mastin (1997) found that interception and evaporation from vegetation during the winter months (approximately 50 percent) far exceeded estimates for western Washington, and attributed the high rate to the large surface area provided by evergreen trees, relatively warm winter temperatures, and the advective evaporation of precipitation. Bidlake and Payne (2001) and Calder (1990) also found that the aerodynamically rough forest canopy and **advection energy** supported evaporation rates of intercepted precipitation that were higher than previously estimated radiation-based potential **evapotranspiration**.

“Water budget studies of wet coniferous forests in western Washington, British Columbia, and the United Kingdom indicate that approximately 40 percent of the annual rainfall is intercepted by foliage and evaporated during the rainy season.”

1

1.2 Impacts of Urbanization

Native soils also play a critical role in storing and conveying Pacific Northwest (PNW) rainfall. Typically, 2-4 feet of soil, high in organic material and biologically active near the surface, overlays the subsurface geology. Solar radiation and air movement provide energy to evaporate surface soil moisture that contributes to the overall evapotranspiration component. Soil biota and organic matter chemically and physically bind mineral particles into stable aggregates that build soil structure, increase soil porosity, and provide 20-30 percent of active water storage by volume. Shallow subsurface flow (interflow) moves slowly down slope or down gradient and, depending on the soil characteristics, may take many hours, days or weeks to move through these upper soil layers to receiving waters. Depending on the underlying soil type and geology, 10-40 percent of the annual precipitation moves to deeper groundwater (Bauer and Mastin, 1997).

For most storm events in the region, the gentle rainfall intensities are less than the combined capacity of native Puget Sound forests and soils to intercept and store the precipitation; as a result, overland flow does not occur or is minimal (Booth, Hartley and Jackson, 2002). Instead, the storm flow moves downslope below the surface at a much slower rate than overland flow and displaces antecedent, subsurface water in areas near streams, lakes and wetlands (Bauer and Mastin, 1997). The displaced soil water adjacent to water bodies contributes to stream flows or wetland and lake levels rather than the entire watershed.

As storms and the wet season progress, available soil storage capacity declines and the saturated or contributing areas near receiving waters increase as does the response to storm events (Booth et al., 2002). Watershed hydrology is dynamic, and changes depending on numerous antecedent conditions and seasonality.

1.2 Impacts of Urbanization

The conversion of the U.S. landscape to urban development is occurring rapidly. From 1954 to 1997 the urban land area grew from approximately 18.6 to 74 million acres, and during the latter part of that time period (1982 to 1997) the population grew by 15 percent while developed land increased by 34 percent, or 25 million acres. Analyses of 22 metropolitan areas revealed that 95 percent of building permits were on green field sites (EPA, 2006).

The transition from a native landscape to a built environment increases the impervious surface coverage of roads, parking areas, sidewalks, rooftops, and landscaping. These changes reduce, disrupt or entirely eliminate native vegetation, upper soil layers, shallow depressions, and native drainage patterns

figure 1.1

Satellite images of Puget Sound urbanization in 1970 and 1996. Dark color in the lowland areas indicates clearing of vegetation and development.

Source: American Forests

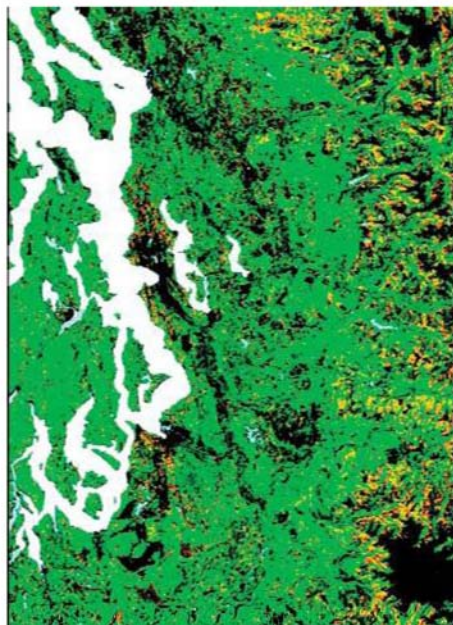

1970

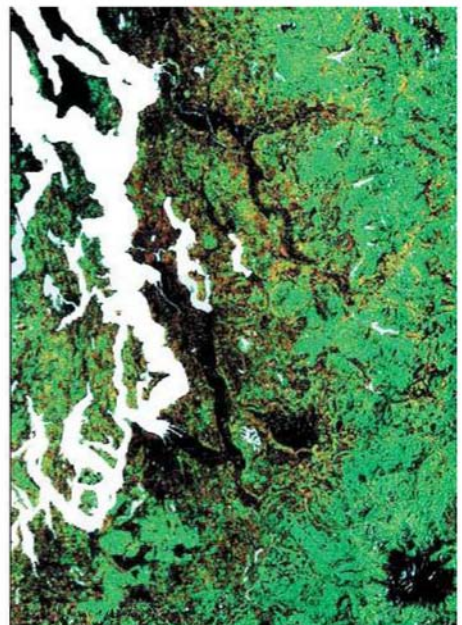

1996

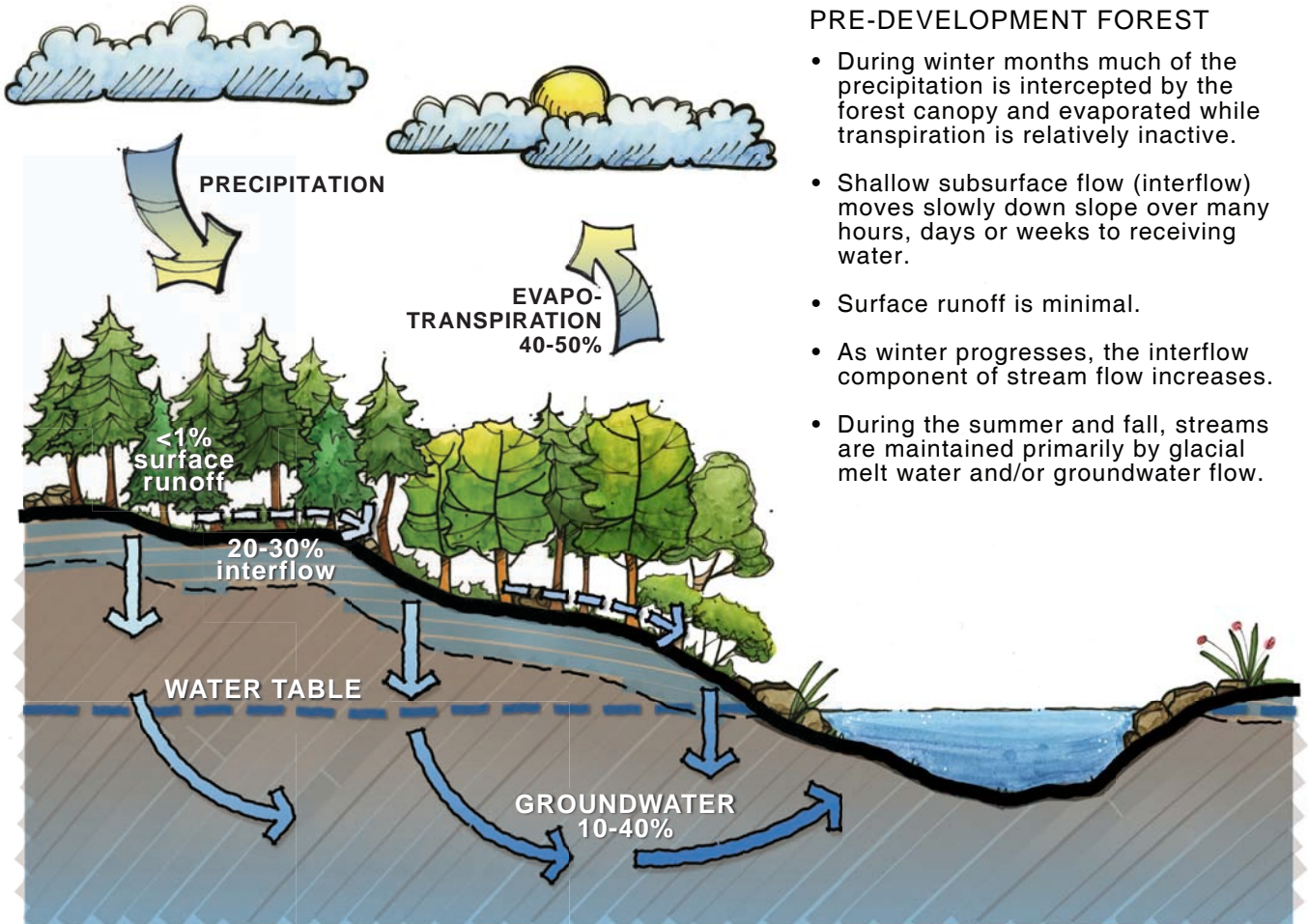

PRE-DEVELOPMENT FOREST

- During winter months much of the precipitation is intercepted by the forest canopy and evaporated while transpiration is relatively inactive.
- Shallow subsurface flow (interflow) moves slowly down slope over many hours, days or weeks to receiving water.
- Surface runoff is minimal.
- As winter progresses, the interflow component of stream flow increases.
- During the summer and fall, streams are maintained primarily by glacial melt water and/or groundwater flow.

Puget Sound lowland forest water budget before development.
Source: AHBL

figure 1.2

1.2 Impacts of Urbanization

that intercept, evaporate, store, slowly convey, and infiltrate stormwater. As development progresses, the area in small watersheds that contribute overland flow to receiving waters in minutes increases while the area that stores and delivers subsurface flow over periods of hours, days or weeks diminishes (Booth et al., 2002). See figure 1.4.

“Altered watershed hydrologic regimes and associated channel instability are one of the leading causes for in-stream physical habitat degradation and loss of biotic integrity.”

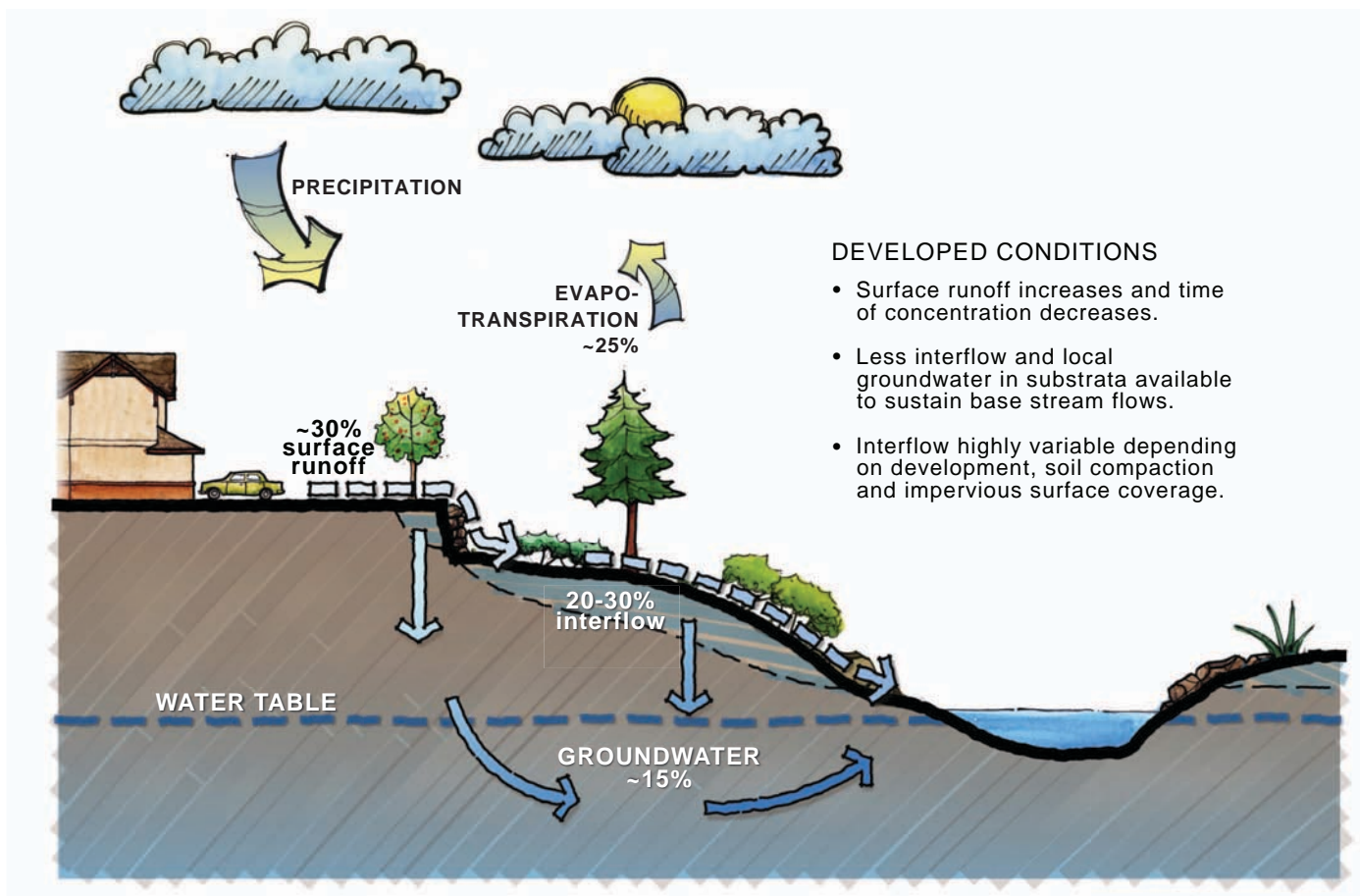

figure 1.3 Water budget for typical suburban development in the Puget Sound lowlands. Source: AHBL

Streams

Loss of native soils and vegetation within the watershed and associated changes in hydrologic regimes can significantly degrade stream habitat (Booth, 1991).

Bankful discharges—the 1-1.5-year return storm flow that contributes significantly to formation of a stream channel—increase in magnitude and frequency (Center for Watershed Protection [CWP], 2000a). Typical responses in streams exposed to high flows for longer periods of time include:

- Excessive streambed and stream bank instability (May, Horner, Karr, Mar, and Welch, 1997).
- Increased stream channel cross-sectional area (typically, cross sectional area is enlarged 2-5 times depending on the amount of total impervious area and other development factors) (CWP, 2000a and March 2000).
- Overall loss of habitat structure, and hydraulic diversity (Booth, 1991).

While water quality conditions (as defined by dissolved oxygen, temperature, sediment, various pollutant concentrations, and other parameters) are critical considerations for managing stream health, altered watershed hydrologic regimes and associated channel instability are also a leading cause for in-stream physical habitat degradation and initial loss of **biotic integrity** (May et al., 1997).

Streams respond to watershed urbanization through several other important mechanisms as outlined in Table 1.1 (MacCoy and Black, 1998; May et al., 1997; Staubitz, Bortleson, Semans, Tesoriero, and Black 1997; and Washington Department of Ecology, 1999). The cumulative impact of hydrologic alteration and the various other changes in watershed conditions can result in channel instability and degraded biotic integrity at low or typically rural levels of watershed development. Studies conducting empirical stream assessments in the Puget Sound region observed physical degradation of channels with **effective impervious area** (EIA) percentages of less than 10 percent within the contributing watersheds (Booth et al., 2002). While impervious surface coverage generally is low at this density, forest clearing for pasture, lawns and hobby farms can be extensive across the rural landscape (see figure 1.4).

1

1.2 Impacts of Urbanization

table 1.1 Degradation of watershed conditions and stream response table.

Change in watershed condition	Response
Increased total and effective impervious area	<ul style="list-style-type: none"> Increased storm flow volume, peak flow intensity and frequency, and channel erosion. Increased fine sediment and urban water pollutant loads. Likely reduction in local groundwater recharge and summer base flows (in non-glacial fed streams).
Increased drainage density due to road networks, road crossings and stormwater outfalls acting as effective tributaries to existing streams	<ul style="list-style-type: none"> Increased storm flow volume, peak flow intensity and frequency, and channel erosion. Increased fine sediment and urban water pollutant loads. Increased fish passage barriers.
Increased fine sediment deposition	<ul style="list-style-type: none"> Reduced inter-gravel dissolved oxygen levels in streambed. Loss of salmonid spawning and macroinvertebrate habitat.
Loss or fragmentation of riparian areas	<ul style="list-style-type: none"> Reduced delivery of large woody debris. Reduced bank stability and loss of bank habitat structure and complexity. Reduced shading and temperature control.
Reduced quantity and quality of large woody debris	<ul style="list-style-type: none"> Reduced channel stability, sediment storage, instream cover for fish and insects, loss of pool quality and quantity.
Increased pollutant concentrations and loads	<ul style="list-style-type: none"> Synthetic organic compounds and trace elements, some acutely toxic; tumors in fish; altered spawning and migration behavior in salmon and trout in presence of metals as low as <1 percent of lethal concentration; endocrine disruptors (18 of 45 suspected endocrine disrupting trace elements found in Puget Sound fish tissue). Disruption of salmonids' ability to avoid prey when combinations of common pesticides, at levels commonly found in receiving waters, are present. Synergistic influence of multiple types of pollutants not well understood. Nutrients: excessive aquatic plant growth; excessive diurnal oxygen fluctuations.

EROSIONAL STABILITY, PEAK FLOWS, AND LAND USE

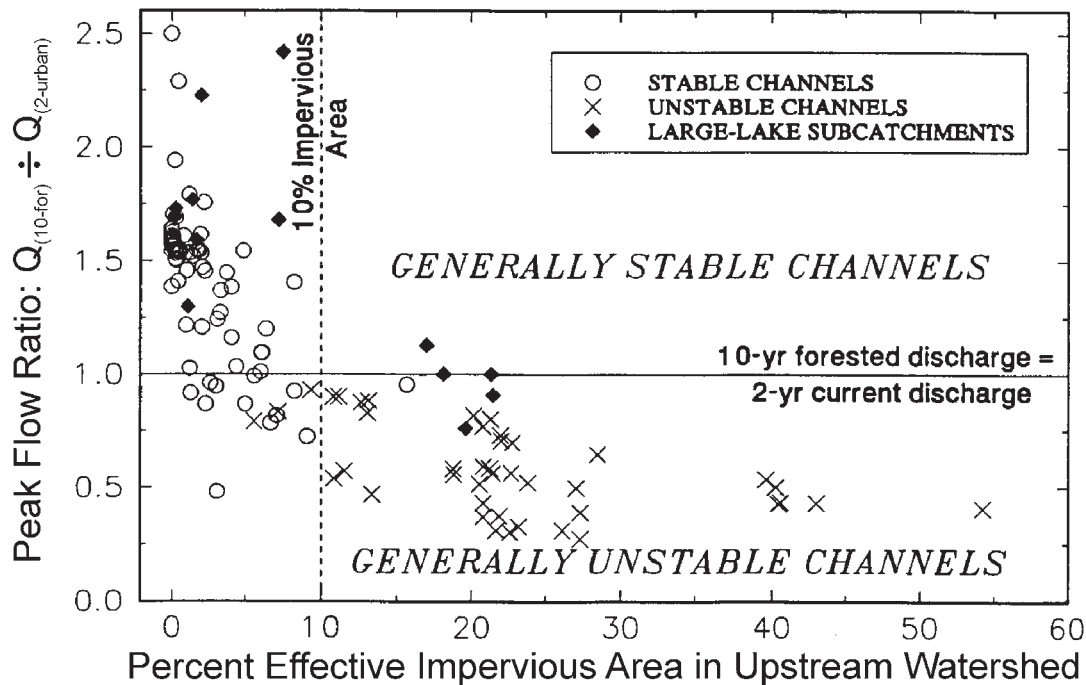

figure 1.4

Observed stable and unstable stream channels in the Puget Sound lowlands plotted by percent EIA and ratio of modeled 10-year forested and 2-year urbanized discharges. Stable channels in this study consistently meet the apparent thresholds of EIA <10% and $Q_{(2\text{-year urban})} \leq Q_{(10\text{-year forest})}$ (Booth et. al., 2002).

Source: Booth and Jackson, 1997

Hydrologic analysis of the same watersheds observed the same relationship between low levels of imperviousness, changes in modeled stream flows (recurrence of pre-developed forest and developed flows), and stream channel stability. (See figure 1.4) Booth, Hartley and Jackson (2002) note that observed channel instability is a relatively insensitive evaluation tool and the lack of observed degradation does not guarantee the absence of subtle, but important consequences for the physical or biologic health of streams.

A recent national study by USGS (2010) assessing levels of urbanization and the physical, chemical and biological response of 2nd to 3rd order streams in nine metropolitan areas across the U.S. suggest

that significant impacts occur at very low levels of watershed development. Macroinvertebrate assemblages were altered in basins perceived to be relatively undisturbed, and the commonly proposed threshold of 5-10 percent maximum impervious area is not protective of stream invertebrates for conventional development patterns. Antecedent land use plays a role in how streams respond to urbanization. For example, macroinvertebrates respond relatively less to land use changes (urbanization) in streams already degraded by agriculture. The physical and chemical variables most associated with urbanization and macroinvertebrate response were: increased flashiness, conductivity, sulfates, chlorides, pesticides, polycyclic aromatic hydrocarbons, and toxicity indices.

Wetlands and lakes

The physical and chemical composition of wetlands and lakes are altered in response to land development as well. Typically, water levels in wetlands gradually rise in the beginning of the wet season and then slowly subside as the wet season ends. Wetland plant species have adapted to this fairly narrow and stable range of water depths and soil saturation (CWP, January 2000c). As development proceeds and impervious surfaces replace native vegetation and soils, water levels can rise rapidly in response to individual storms. A major finding of the Puget Sound Wetlands and Stormwater Management Program was that “hydrologic changes were having more immediate and measurable effects on composition of vegetation and amphibian communities than other conditions [monitored]” (Azous and Horner, 2001). Decline in wetland plant and amphibian species richness are likely when:

- Mean annual water level fluctuations exceed 20 cm (7.8 inches) per year.
- The frequency of **stage excursions** of 15 cm (6.0 inches) above or below pre-development condition exceeds an annual average of six.
- The duration of stage excursions of 15 cm (6.0 inches) above or below pre-development condition exceeds 72 hours per excursion.
- The total dry period (when pools dry down to the soil surface everywhere in the wetland) increases or decreases by more than two weeks in any year (Azous and Horner, 2001).
- Increased water level fluctuations occur early in the growing season (CWP, January 2000c).

Increased water level fluctuations of this nature are observed when total impervious area within the drainage area exceeds 10-15 percent (Taylor, 1993).

Lakes and estuaries, while not as prone to morphological change due to altered hydrology, are highly susceptible to shoreline modifications and water quality degradation from urbanization. Phosphorus, bacteria and sediment are typical urban stormwater pollutants impacting lakes. Phosphorus is often a limiting nutrient in fresh water systems, and contributes to increased plant growth and diurnal oxygen level

fluctuations that degrade wildlife habitat, recreational opportunities and other beneficial uses.

Bacteria can restrict or close shellfish growing areas in Puget Sound to harvest. Nonpoint source pollution (including stormwater runoff) is now “the most common cause of shellfish classification downgrades in Puget Sound, reducing the region’s commercially approved acreage by approximately 25 percent since 1980” (PSAT, 2004). Toxic pollutants associated with stormwater sediments (e.g., heavy metals and polycyclic aromatic hydrocarbons) that settle in urban estuaries and near shore areas have contributed to the listing of several urban bays as Superfund (federal) or Model Toxic Control Act (state) clean-up sites.

Water Quality & Aquatic Biota

Relatively little attention has been given to sub-lethal and other effects of urban runoff pollutant mixtures on fish and aquatic invertebrates compared to hydrologic impacts of urbanization and impacts of individual pollutants on aquatic biota. Recent research indicates that mixtures of common pesticides at concentrations commonly found in the environment can have negative effects on salmon. Individual pesticides may have little or no measureable effect, but certain pesticide combinations can act synergistically and cause death and sub-lethal effects in survivors, including inhibition of critical brain enzymes, resulting in changes to associated olfactory function and behaviors (sensing and avoiding predators) that are essential for survival (Laetz et. al., 2008).

Low levels of copper in water (0.2µg/L) may cause sub-lethal effects in salmon, inhibiting olfactory function and the ability to sense chemical signals in the water to avoid predators and migrate to find natal streams (Sandahl, 2004). Furthermore, fish exposed to complex mixtures of polycyclic aromatic hydrocarbons from oil exhibit several abnormalities, including cardiac dysfunction, edema and spinal curvature (Incardona, 2004).

Aquatic biota are exposed not to a single pollutant, but complex mixtures of chemicals in the environment. Conventional assessment of individual pollutants at levels that cause mortality may be overly simplistic. Low level exposure to typical pollutants may inhibit essential functions in salmon and the effect of some common individual pesticides likely increases significantly in mixtures. Evidence now suggests that these types of exposures inhibit healthy growth and the ability of fish to sense their environment, which can lead to mortality.

1.3 Current Stormwater Management

Conventional tools to manage stormwater are mitigation-based and flood-control focused. This strategy emphasizes the efficient collection and rapid conveyance of runoff from residential and commercial development to central control ponds. Several factors have led to the implementation and continuation of this approach:

- Stormwater has been perceived as a liability and applications have evolved from wastewater technology.
- Hard conveyance structures and central control ponds are considered reliable and relatively simple to maintain.
- The conveyance and collection approach is relatively simple to model for regulatory requirements.
- Construction costs are readily estimated.

Newer conveyance and pond strategies, if properly designed and maintained, can help to match modeled pre-development peak flows and runoff rates discharged from development sites; however, a number of problems will continue to challenge conveyance and pond management strategies. These include:

- *Water quality treatment.* Several pollutants of concern (e.g., bacteria, flame retardants and plasticizers) and dissolved pollutants (e.g., low levels of dissolved copper) are likely not treated adequately or pass through conventional treatment systems.

- *Local groundwater recharge.* Recharge may be reduced or altered, reducing summer base flow of streams and hydroperiods in wetlands.
- *Spatial Distribution.* Conventional management converts spatially distributed subsurface flows to point discharges. No analysis is currently available that focuses on the larger hydrologic impacts of this transition; however, severe erosion, disturbed riparian habitat, and degraded in-stream habitat can result at point discharge locations (Booth et al., 2002).
- *Density, stormwater management and market implications.* Duration-control design standards in Washington Department of Ecology's (Ecology) *Stormwater Management Manual for Western Washington (SWMMWW)* require large ponds to detain and treat storm flows. As a larger percentage of land within a development is designated for stormwater management, stormwater infrastructure costs will increase and the number of buildable lots will likely decrease. In this context, several analyses suggest that increasing density and strategically conserving native soils and vegetation are essential tools for protecting receiving waters from the impacts of urbanization (Horner, May, Livingston, Blaha, Scoggins, Tims, Maxted, 2001; May et al. 1997; USEPA, 2006).

The conventional, purely structural approach to manage stormwater runoff has limitations for recovering adequate storage, providing adequate treatment and creating spatially distributed flow paths necessary to more closely approximate pre-development hydrologic function and protect aquatic resources from adverse effects of development.

1.4 Low Impact Development

Low impact development (LID) principles and applications present a significant conceptual shift from a purely structural to a primarily source reduction approach. Site planning and stormwater management are integrated at the initial design phases of a project to maintain a more **hydrologically functional landscape** even in denser settings. Hydrology and natural site features that influence water movement guide road, structure, and other infrastructure layout. Native soil and vegetation protection areas and landscaping are strategically distributed throughout the project to slow, store, and infiltrate storm flows, and also serve as project amenities.

Pre-development or natural hydrologic function is the relationship among the overland and subsurface flow, infiltration, storage, and evapotranspiration characteristics of the forested landscape predominant in the Puget Sound lowland (see Section 1.1). LID strategies focus on intercepting, evaporating, transpiring, and infiltrating stormwater on-site through native soils, vegetation, and bioengineering applications to reduce and treat overland flow to more closely match forest conditions.

1.4.1 Low Impact Development Definition

Low impact development is a stormwater and land use management strategy that strives to mimic pre-disturbance hydrologic processes of infiltration, filtration, storage, evaporation and transpiration by emphasizing conservation and use of on-site natural features, site planning, and distributed stormwater management practices that are integrated into a project design. LID strategies can be applied to new development, urban retrofits, infrastructure improvements and revitalization projects to protect aquatic resources.

1.4.2 Goal of Low Impact Development

The goal of LID is to prevent measurable physical, chemical or biological degradation to streams, lakes, wetlands, and other natural aquatic systems from commercial, residential or industrial development sites.

1.4.3 LID Flow Control Objective

The primary stormwater management objective for LID is to approximate pre-development (native) forested hydrologic condition (or prairie condition if historic records indicate that as the native setting) over the full range of rainfall intensities and durations. Note that this management objective, within the LID context, provides the highest level of protection for streams and wetlands.

1.4.4 Flow Control Objective & Department of Ecology's SWMMWW

This manual does not supersede the requirements of any National Pollutant Discharge Elimination System (NPDES) permit or the current version of Ecology's Stormwater Management Manual for Western Washington (2012 SWMMWW). The flow control objective required for LID in the 2012 SWMMWW is the following:

Minimum Requirement #5 (LID Performance Standard) Stormwater discharges shall match developed discharge durations to pre-developed durations for the range of pre-developed discharge rates from 8 percent of the 2-year peak flow to 50 percent of the 2-year peak flow. Refer to the Standard Flow Control Requirement section in Minimum Requirement #7 for information about the assignment of the pre-developed condition. Project sites that must also meet minimum requirement #7 (Flow Control) must match flow durations between 8 percent of the 2-year flow through the full 50-year flow.

Some development sites have limitations that make attaining the performance standard unlikely. Project sites within the urban growth area can choose to meet the LID performance standard or implement BMPs from specified lists. The list option requires the use of the highest priority BMPs that are considered feasible for all surfaces of the site. Sites that use the list option do not have to demonstrate compliance with the LID performance standard. However, sites that are also subject to Minimum Requirement #7 (Flow Control) must still demonstrate compliance with that requirement. This can be done through use of approved continuous runoff models that predict runoff

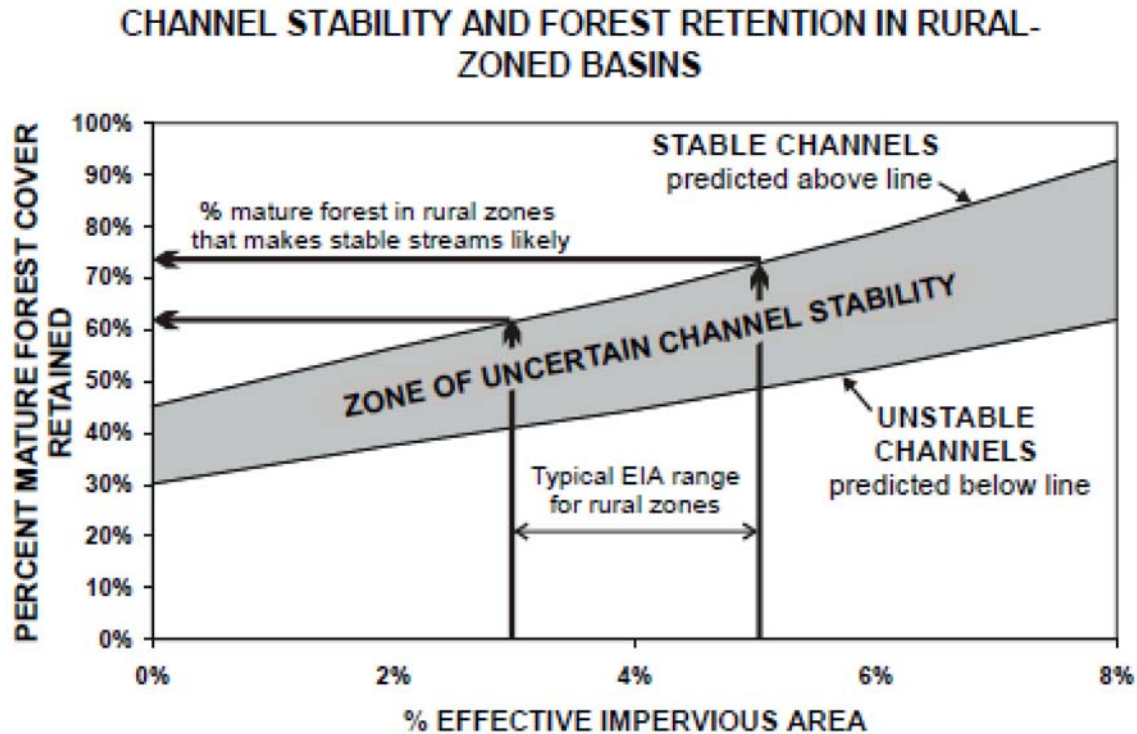

Modeled channel stability plotted by percent forest cover retained and percent EIA.

Source: Booth et. al., 2002

figure 1.5

from developed sites that include LID BMPs and/or retention/detention facilities. Portions of projects that use Full Dispersion (BMP T5.30) or Downspout Full Infiltration (BMP T5.10A) do not have to enter those areas into the runoff models.

1.4.5 LID Flow Control Objective Discussion

Maintaining the pre-development hydrologic regime cannot be achieved everywhere or at all times given current development practices. The hydrologic system of our region evolved from, and is dependent on, the characteristics of undisturbed Pacific Northwest watersheds - mature forest canopy, uncompacted soils, ungullied hillslopes - and cannot be expected to have the same hydrologic regime when significant portions of a site are disturbed. The objectives of any given low impact development, therefore, must be strategically chosen, recognizing both the opportunities and the

limitations of any given site. Regulatory requirements, underlying zoning and housing types, and costs of sophisticated control technology required on sites with poor soils, higher densities, steep slopes, shallow groundwater, and groundwater movement create significant challenges for reducing or eliminating hydrologic impacts from development sites. These challenges are likely to be most prominent during periods of extended rainfall, when distributed on-site infiltration reservoirs common to most LID designs will experience their highest water levels and can approach, or reach, full saturation.

Initial monitoring in the Puget Sound region suggests that LID strategies can be effective for maintaining pre-development hydrologic condition for light to moderate storm events typical of a maritime climate (Horner, Lim and Burges, 2002). Effectiveness in mimicking

1

1.4 Low Impact Development

pre-development hydrology for large storms and during extended wet periods is not well documented. However, initial monitoring of projects on soils with low permeability suggests that pre-development hydrology can be approximated with little or no surface flow release (Hinman, 2005). On difficult sites with low infiltration rates and higher densities, additional storage using conventional retention or detention pond facilities may be necessary in concert with LID strategies to meet regulatory requirements. Properly designed and implemented LID applications will significantly reduce pond size requirements (Derry, Butchart and Graham, 2004 and Horner et al., 2002).

1.4.5.1 Rural Setting

Empirical data coupled with hydrologic modeling analysis at the watershed scale suggest that retaining 65 percent mature forest cover is necessary to mimic pre-development hydrologic conditions and maintain stable stream channels on moderately sloping till soils and typical rural development settings (EIA 3-5 percent). While this is an estimate of complex hydrologic processes, the 65 percent cover is a defensible target for forest protection in rural densities (see figure 1.5) (Booth et al., 2002).

Forested glacial outwash soils produce less overland flow than forested till soil conditions during storm events. As a result, forest clearing and increased impervious surface coverage can produce relatively larger peak flows and increases in volume on outwash soils without adequate infiltration practices (Booth et al., 2002). The impact of concentrating infiltration facilities at a single location on outwash soils is not known; however, shallow subsurface flows may alter hydrologic characteristics if the development and facility are located proximate to a headwater stream.

Stormwater pollutant treatment is required when infiltrating stormwater on outwash soils from pollution generating surfaces (Washington Department of Ecology, 2001). Processing pollutants in a facility that collects storm flows from an entire development can significantly increase infrastructure requirements and costs. Accordingly, 65 percent native soil and

vegetation protection and application of dispersed LID infiltration practices is recommended for protecting stream and wetland habitat in forested outwash soil and rural settings.

1.4.5.2 Medium and High-density Settings (6 or more dwelling units per acre)

Initial research modeling experimental, medium-density, residential LID designs indicates that pre-development hydrologic conditions may be approximated on soils with low infiltration rates when using the full suite of LID practices and 40 to 50 percent open space protection (CH2M HILL, 2001). Initial monitoring of projects on soils with low permeability suggests that pre-development hydrology can be approximated with little or no surface flow release in medium-density settings (Hinman, 2005).

In medium to high-density development on soils with low permeability, a comprehensive application of LID practices is necessary to reduce hydrologic changes and pollutant loads to surface and ground waters (see Chapter 3: Site Planning and Layout for design strategies). Soil enhancement, bioretention, open conveyance, dispersion to open space, minimal excavation foundation systems, aggregate storage under permeable paving, and roof water harvesting techniques must be integrated into the design to minimize hydrologic impacts. Eliminating the roof water contribution through roof water harvesting systems may be necessary for achieving the LID flow objective where higher density projects are located on soils with low infiltration rates.

The 65 percent target for mature native vegetation coverage may be achievable in medium and high-density settings by applying multifamily, cottage, or condominium type development. Sixty-five percent native vegetation and soil protection is not feasible with conventional single family detached housing at such densities.

1.4.6 Verifying LID Flow Control Objectives

The impact to receiving waters (and determining if a project has achieved the above goal) is estimated

by hydrologic models and measured by monitoring surface and ground water quality and quantity, and biological health of receiving waters.

1.4.7 Site Design and Management Strategies to Meet Flow Control Objectives

The goal and flow control objective for LID are achieved through the following site design objectives. The objectives are grouped into four basic elements that constitute a complete LID design.

Conservation Measures

- Maximize retention of native forest cover and restore disturbed vegetation to intercept, evaporate, and transpire precipitation.
- Preserve permeable, native soil and enhance disturbed soils to store and infiltrate storm flows.
- Retain and incorporate topographic site features that slow, store and infiltrate stormwater.
- Retain and incorporate natural drainage features and patterns.

Site Planning and Minimizing Site Disturbance Techniques

- Utilize a multidisciplinary approach that includes planners, engineers, landscape architects and architects at the initial phases of the project.
- Locate buildings and roads away from critical areas and soils that provide effective infiltration.
- Reduce the development envelope, minimize road networks (density) and reduce or eliminate road stream crossings.
- Minimize total impervious surface area and minimize or eliminate effective impervious surfaces.

Distributed and Integrated Management Practices

- Manage stormwater as close to its origin as possible by utilizing small scale, distributed hydrologic controls.
- Create a hydrologically rough landscape that slows storm flows and increases time of concentration.

- Increase reliability of the stormwater management system by providing multiple or redundant LID flow control practices.
- Integrate stormwater controls into the development design and utilize the controls as amenities - create a multifunctional landscape.
- Reduce reliance on traditional conveyance and pond technologies.

Maintenance and Education

- Develop reliable and long-term maintenance programs with clear and enforceable guidelines.
- Educate LID project homeowners and landscape management personnel on the operation and maintenance of LID systems and promote community participation in the protection of those systems and receiving waters.

Subsequent sections of this manual - Chapter 3: Site Planning and Layout; Chapter 4: Vegetation and Soil Protection and Reforestation; Chapter 5: Precision Site Preparation, Construction and Inspection of LID Facilities; Chapter 6: Integrated Management Practices; and Chapter 7: Flow Modeling Guidance - provide information on low impact development tools and techniques that can be used to meet the objectives and strategies listed above. This manual outlines many of the tools available for designing a low impact development system, but it does not provide an exhaustive list of practices. The LID approach is creative and designers must consider the attributes of individual sites in the context of the local jurisdiction and community. Designers should apply sound science, an interdisciplinary approach and, at times, unique applications to meet LID goals and objectives. See Table 1.2 for a list of LID techniques and the techniques covered in this manual.

While the focus of low impact development and this manual is to more effectively manage stormwater, LID can and should address other livability issues including:

- Residential road design that reduces traffic speeds, increases pedestrian safety, and promotes walking and biking as alternative transportation methods.

1

1.4 Low Impact Development

table 1.2 LID techniques (checked items are examined in this manual).

✗	Site assessment	✗	Urban trees		Living walls
✗	Site planning and design	✗	Amending construction site soils		Downspout dispersion
✗	Site phasing and fingerprinting	✗	Porous asphalt		Filter strips
✗	Preserving native soils and vegetation	✗	Pervious concrete		Constructed wetlands
✗	Precision site preparation and construction	✗	Permeable plastic and concrete grid systems		Subsurface gravel wetland
✗	Bioretention cells	✗	Permeable pavers	✗	Maintenance
✗	Bioretention swales	✗	Vegetated roofs		Homeowner education
✗	Bioretention planters	✗	Roof rainwater harvesting systems		
✗	Rain Gardens	✗	Minimal excavation foundations		

- Development at appropriate densities that meets state Growth Management Act (GMA) goals and increases access to, and connection between, public transportation modes.
- Subdivision layout and building design that promote interaction between neighbors and connection to open space, recreation areas and core services (grocery, library, etc.).

1.4.8 Low Impact Development in the Watershed Context

LID is a tool for retrofitting existing or constructing new commercial and residential development at the parcel and subdivision scale. LID can also be effective for many municipal and industrial site new development or retrofits. Maintaining aquatic habitat, water quality, species of special concern, and healthy aquatic systems in general requires protection or restoration of processes (e.g., the movement of water and recruitment of large woody debris) and structures (e.g., forest canopy, soils) at the sub-watershed, watershed or regional scale.

To protect high quality, sensitive stream systems the following critical area designations and associated land use controls are necessary:

- Extensive and near continuous riparian buffer protection.
- Floodplain protection.
- Aggressive native forest and soil protection.
- Limit EIA to approximately 10 percent.

(Horner, May, Livingston, Blaha, Scoggins, Tims, Maxted, 2001 and May et al., 1997)

Where higher levels of EIA and development exist or are proposed and ecological function is good or impaired (but not entirely lost), several strategies can be employed for protection and enhancement including, but not limited to: forest and soil restoration; comprehensive drainage design addressing cumulative impacts and implementing regional stormwater control facilities; and other mitigation and enhancement measures (May et al., 1997).

To improve sub-watershed or regional scale ecosystem functions, basin assessments must evaluate the quality and sensitivity of resources, the cumulative impacts of existing development, and future growth and other activities in sub-watersheds. Through the assessment and planning process, managers should set priorities for resource protection for sub-watersheds based on resource sensitivity and growth pressures. Various landscape analysis tools are available that allow managers to assign appropriate densities and types of development based on the projected cumulative impacts of different land use scenarios.

1.4.9 Low Impact Development and Comprehensive Stormwater Management

LID does not compensate for the cumulative and adverse effects from road networks and other land clearing activities that occur outside the development site. Low impact development can, however, be used in the various sub-basin development scenarios to help achieve larger-scale, sub-watershed protection goals. Implemented comprehensively, native soil and vegetation protection, soil improvement, and increased on-site storage and infiltration capacity at the site level are necessary to protect or enhance larger-scale hydrologic function and other watershed attributes.

While LID works with and supports the effective implementation of regional stormwater management plans and land use planning under the state GMA, it is not a substitute for these local government responsibilities. The use of LID techniques should be part of a local, comprehensive stormwater management program that includes:

- Adopting the current version of Ecology's *Stormwater Management Manual for Western Washington* (or an alternative manual that is technically equivalent).
- Regular inspections of construction sites.
- Maintenance of temporary and permanent facilities.
- Source control.
- Elimination of illicit discharges.

- Identification and ranking of existing stormwater problems.
 - Public education and involvement.
 - Watershed or basin planning.
 - Stable funding.
 - Programmatic and environmental monitoring.
- (Puget Sound Action Team, 2000)

THIS PAGE
INTENTIONALLY
LEFT BLANK

Site Assessment

2

CHAPTER

Stormwater Site Plans	2.1
Soil and Subsurface Hydrology Characterization	2.2
Hydrologic Patterns & Features	2.3
Native Forest & Soil Protection Areas	2.4
Wetlands	2.5
Riparian Management Areas	2.6
Streams	2.7
Floodplains	2.8
Sub-basin Delineation	2.9
Site Mapping Process	2.10

Comprehensive inventory and assessment of on-site and adjacent off-site conditions are important first steps for designing and implementing a low impact development project. The inventory and assessment process will provide information necessary to implement the site planning and layout activities (examined in the next section) by identifying current (if disturbed) and estimating pre-disturbance conditions. Specifically, site hydrology, topography, soils, vegetation and water features are evaluated to identify how the site currently processes stormwater. Roads, lots and structures are aligned, and construction practices are implemented to preserve and utilize these features to retain natural hydrologic function. In most all cases, low impact development requires on-site inventory and assessment and cannot be properly planned and implemented through map reconnaissance alone.

“Site inventory and assessment provides information necessary to implement site planning and layout by identifying current (if disturbed) and estimating pre-disturbance conditions.”

2

2.1 Stormwater Site Plans

Jurisdictions in the Puget Sound region have various requirements for identification and assessment of site characteristics and site plan development. Most local governments include some or all of the following existing conditions in their requirements for site assessment:

Geotechnical/soils	Streams	Wetlands
Floodplains	Lakes	Closed depressions
Springs/seeps	Other minor drainage features	Groundwater
Existing hydrologic patterns	Slope stability and protection	Geology
Habitat conservation areas	Aquifer recharge areas	Topography
Vegetation/forest cover	Anadromous fisheries impacts	Existing development
Erosion hazard areas	Offsite basin and drainage	Down-stream analysis

To successfully implement a low impact development project, inventory and evaluation will include some or all of the above existing conditions, depending on the physical setting and regulatory requirements; however, the objectives of the analysis and the level of detail necessary may vary.

Site analysis can be divided into two broad categories of activities:

1. Gathering existing analyses, inventories and historic information about the site, which includes (but is not limited to):
 - Soil surveys (soil surveys provide very broad characterization of regional soils and are not adequate for making detailed design decisions).
 - Soil analyses from adjacent properties.

- Historic records documenting filling/altering of wetlands or stream channels.
- Aerial photos.
- Maps and site reconnaissance verifying topography.
- Location of groundwater protection areas and/or 1, 5 and 10 year time of travel zones for municipal well protection areas.
- A description of local site geology, including soil or rock units likely to be encountered, the groundwater regime, and geologic history of the site.

2. Site reconnaissance and characterization. The remainder of the Site Assessment chapter outlines the steps necessary to adequately characterize the hydrologic, geologic and biologic conditions on-site. This characterization will inform the overall design and location of infrastructure with the goal of preserving and using on-site features to function hydrologically with integrated management practices (IMPs) to manage stormwater.

2.1 Stormwater Site Plans

The Stormwater Site Plan is the comprehensive report containing the technical information and analysis necessary for regulatory agencies to evaluate a proposed new development or redevelopment project for compliance with stormwater requirements. Contents of the Stormwater Site Plan will vary depending on the Minimum Requirements applicable to the project and individual site characteristics (see the 2012 SWMMWW Vol. 1, Chapter 2 for Minimum Requirements and thresholds triggering those requirements).

The following provides guidelines on developing overall site analysis to analyze existing site conditions. Soil analysis to evaluate soil permeability for individual bioretention or permeable pavement installations may require additional testing at specific locations and frequency. However, the location and frequency of soil analysis should be coordinated with the overall site analysis and site plan development as much as possible

to reduce evaluation costs. For recommendations on test frequency and correction factors specific to bioretention, see Section 6.1.2.1: Determining subgrade and bioretention soil media design infiltration rates. For recommendations on test frequency and correction factors specific to permeable pavement, see “Determining subgrade infiltration rates” under Section 6.3.2.1: Common components, design and construction criteria for permeable pavement systems.

For additional steps to complete an overall site plan (preliminary development layout, off-site analysis, determining minimum requirements, permanent stormwater control plan, construction stormwater pollution prevention plan, and the complete stormwater site plan), see Chapter 3 of Volume 1 of the *SWMMWW*.

2.1.1 Site Analysis for Projects Required to Meet Minimum Requirements 1-5

Projects triggering Minimum Requirements 1-5 in the 2012 *SWMMWW* are generally smaller projects ranging from a single-family residence or multifamily residence up to 2-3 homes. The following provides the minimum analysis and technical information necessary to properly design and implement an LID project and for the regulatory agency to evaluate the proposed project for compliance with stormwater requirements.

- A survey prepared by a registered land surveyor showing:
 - » Existing public and private development, including utility infrastructure on and adjacent (if publicly available) to the site.
 - » Minor hydrologic features, including seeps, springs, closed depression areas and drainage swales.
 - » Major hydrologic features with a streams, wetland, and water body survey and classification report showing wetland and buffer boundaries consistent with the requirements of the jurisdiction.
 - » Flood hazard areas on or adjacent to the site, if present.
 - » Geologic hazard areas and associated buffer requirements as defined by the jurisdiction.

“Site visits should be conducted during winter months and after significant precipitation events to identify undocumented surface seeps or other indicators of near-surface groundwater.”

- » Aquifer and wellhead protection areas on or adjacent to the site, if present.
- » Topographic features that may act as natural stormwater storage, infiltration or conveyance.
- Contours for the survey are as follows:
 - » Up to 10 percent slopes, two-foot contours.
 - » Over 10 percent to less than 20 percent slopes, 5-foot contours.
 - » 20 percent or greater slopes, 10-foot contours.
 - » Elevations shall be at 25-foot intervals.
- A soils report must be prepared by a certified soil scientist, professional engineer, geologist, hydrogeologist or engineering geologist registered in the State of Washington or suitably trained persons working under the supervision of the above professionals or by a locally licensed on-site sewage designer. The report should identify:
 - » *Underlying soil texture and stratigraphy on the site.* Tests for accessing and assessing on-site soil texture and stratigraphy include soil surveys, soil test pits, small-scale Pit Infiltration Test (PIT) or soil borings. Grain size analysis may be substituted for infiltration tests on soils unconsolidated by glacial advance. See <http://websoilsurvey.nrcs.usda.gov/app/HomePage.htm> for soil survey information.
 - » *Infiltration rates of on-site soils.* Infiltration rates for rain gardens, bioretention areas or permeable pavement installations must be assessed using septic style pit tests, small-scale PIT or grain size analysis (if unconsolidated soils) or other small-scale method approved by the local government.

2

2.1 Stormwater Site Plans

See Section 2.2 for PIT and grain size analysis protocol. See Glossary for definition of rain garden and bioretention areas.

“For projects replacing or installing 2,000-5,000 ft² of new hard surface, triggering Minimum Requirement #5 and using a rain garden for stormwater control, guidance for design and installation is available in this manual, the *SWMMWW*, and the *Rain Garden Handbook for Western Washington Homeowners*.”

- » Determine if depth to hydraulic restriction layer (e.g., groundwater, relatively impermeable soil layer, bedrock) under rain gardens or permeable pavement is within one foot of the bottom (subgrade surface) of the infiltration areas, using a monitoring well or excavated pit. This analysis should be performed in the winter season (December 1 through April 1). The optimum time to test for depth to seasonally high groundwater is late winter (e.g., March) and shortly after an extended wet period. Historic site information and evidence of high groundwater can also be used.

“Certified soils professionals can exercise discretion to determine if an infiltration testing program is necessary, if information exists confirming that the site is unconsolidated outwash material (high infiltration rates), and there is adequate depth to groundwater (one foot minimum from bottom of a rain garden, bioretention or permeable pavement installation).”

- If there are native soil and vegetation protection areas proposed for the site, provide a survey of existing native vegetation cover by a licensed landscape architect, arborist, qualified biologist or project proponent identifying any forest areas on the site and a plan to protect those areas (see Chapter 4: Vegetation and Soil Protection and Reforestation for details).
- Preliminary drainage report consistent with the requirements of the jurisdiction’s stormwater management code.
- If sufficient information exists to adequately describe the above site characteristics, the jurisdiction may waive the requirement to conduct the above site analysis.

2.1.2 Site Analysis for Projects Required to Meet Minimum Requirements 1-9

Projects triggering Minimum Requirements 1-9 are larger projects that may be required to comply with Ecology’s water quality treatment and/or flow control requirements. The Site Plan requirements for more complex projects include elements in Section 2.1.1 plus additional characterization. The analysis for site plans are performed by licensed professionals, but not on-site sewage designers. The following provides the minimum analysis and technical information necessary to properly design and implement more complex LID projects and for the regulatory agency to evaluate the proposed project for compliance with stormwater requirements.

- A survey prepared by a registered land surveyor showing:
 - » Existing public and private development, including utility infrastructure on and adjacent to the site.
 - » Minor hydrologic features, including seeps, springs, closed depression areas and drainage swales.
 - » Major hydrologic features with a streams, wetland, and water body survey and classification report showing wetland and buffer boundaries consistent with the requirements of the jurisdiction.

Note that site visits should be conducted during winter months and after significant precipitation events to identify undocumented surface seeps or other indicators of near-surface groundwater.

- » Flood hazard areas on or adjacent to the site, if present.
 - » Geologic hazard areas and associated buffer requirements as defined by the jurisdiction.
 - » Aquifer and wellhead protection areas on or adjacent to the site, if present.
 - » Topographic features that may act as natural stormwater storage, infiltration or conveyance.
- Contours for the survey are as follows:
 - » Up to 10 percent slopes, 2-foot contours.
 - » Over 10 percent to less than 20 percent slopes, 5-foot contours.
 - » Twenty percent or greater slopes, 10-foot contours.
 - » Elevations shall be at 25-foot intervals.
 - A soils report prepared by a certified soil scientist, professional engineer, geologist, hydrogeologist or engineering geologist registered in the State of Washington or suitably trained persons working under the supervision of the above professionals. The report should identify:
 - » *Underlying soil texture and stratigraphy on the site.* Tests for accessing and assessing on-site soil texture and stratigraphy include soil surveys, soil test pits, small-scale PIT and soil borings. Grain size analysis may be substituted for infiltration tests on soils unconsolidated by glacial advance. See <http://websoilsurvey.nrcs.usda.gov/app/HomePage.htm> for soil survey information.
 - » *Saturated hydraulic conductivity (K_{sat}) of site soils.* K_{sat} should be assessed using small-scale or full-scale PIT or grain size analysis (if unconsolidated soils). Full-scale in-situ PIT is the preferred method for measuring the K_{sat} of the soil profile beneath large-scale permeable pavement facilities where stormwater from adjacent impervious surfaces is directed to the pavement surface resulting in higher hydraulic loads. See Section 2.2 for general PIT and grain size analysis protocol, Section 6.1.2.1 for grain size and small-scale PIT procedures specific to bioretention and Section 6.3.2.1 for grain size and small-scale PIT specific to permeable pavement. Placement of infiltration tests should be carefully considered to reduce cost. A few strategically placed PITs are generally adequate for initial site assessment and smaller sites. A more detailed soil assessment and additional K_{sat} testing may be necessary to direct placement of impervious surfaces such as buildings away from soils that can most effectively infiltrate stormwater, and placement of permeable pavement and bioretention over those soils. The K_{sat} tests are also necessary as input to the runoff model to predict the benefits of the LID integrated management practices.
 - » *Prepare detailed logs* for each test pit or test hole and a map showing the location of the test pits or holes. Logs must include depth of pit or hole, soil descriptions, depth to water and presence of stratification. Logs must substantiate whether stratification does or does not exist. The licensed professional may consider additional methods of analysis to substantiate the presence of stratification.
 - » If the general site assessment cannot confirm that the seasonal high groundwater or hydraulic restricting layer is greater than 5 feet below the bottom of the bioretention or permeable pavement (subgrade surface), monitoring wells should be placed strategically to assess depth to groundwater. This analysis should be performed for one wet season (December 1 through April 1) prior to construction using a continuously-logging sensor and be performed by a certified soils professional. Monitoring for less than one wet season may be acceptable by the permitting entity, but the risk of inaccurate characterization increases. Site historic data regarding groundwater levels can be used to replace field testing if the data

2

2.2 Soil & Subsurface Hydrology Characterization

are sufficient to characterize groundwater during wet conditions and the quality of the data is verifiable.

- » If on-site infiltration might result in shallow lateral flow (interflow), the conveyance and possible locations where that interflow may re-emerge should be assessed by a certified soils professional. This will likely require placement of groundwater monitoring wells to determine existing groundwater gradients and flow.
- » If a single bioretention facility serves a drainage area exceeding 1 acre and the depth to a hydraulic restricting layer from the bottom (subgrade) of the bioretention area is less than 15 feet, a groundwater mounding analysis should be done in accordance with Volume III, Section 3.3 of the *SWMMWW*.
- » Precipitation during the monitoring year should be considered in the context of normal annual precipitation depth. Apply appropriate factors of safety to the calculations if annual precipitation is below normal annual depth.
- » If there are native soil and vegetation protection areas proposed for the site, a survey should be conducted of existing native vegetation cover by a licensed landscape architect, arborist or qualified biologist. The survey should identify any forest areas on the site and species and condition of ground cover and shrub layer as well as tree species, condition, **seral stage**, and canopy cover.
- » A plan should be completed by a licensed landscape architect, arborist or qualified biologist to protect native soil and vegetation areas during construction (see Chapter 4: Vegetation and Soil Protection and Reforestation for details).
- » Preliminary drainage report should be prepared by a licensed engineer consistent with the requirements of the jurisdiction's stormwater management code.

2.2 Soil and Subsurface Hydrology Characterization

Low impact development requires in-depth soil and possibly groundwater analysis in appropriate locations to determine operating infiltration rates and soil storage capacity for three primary reasons:

1. LID emphasizes evaporation, storage and infiltration of stormwater in smaller-scale facilities distributed throughout the site.
2. On sites with mixed soil types, the LID site plan should locate impervious areas over less permeable soils and preserve and utilize permeable soils for infiltration.
3. Pre-development soil storage capacity provides baseline data for estimating post-development soil storage needs. Note that for infill and redevelopment projects, the location of existing infrastructure may preclude altering the site layout to take advantage of site characteristics for optimum infiltration.

Soil and subsurface characterization relies to a large extent on infiltration test pits, soil test pits or soil borings. The type and number of these tests for initial site assessment is variable and site specific; however, some general guidelines are appropriate. A few strategically placed tests are generally adequate for initial soil and infiltration assessment. Test locations are determined by topography, estimated soil type, hydrologic characteristics, and other site features. Consult a certified soil scientist, professional engineer, geologist, hydrogeologist or engineering geologist registered in the State of Washington or suitably trained persons working under the supervision of the above professionals or a locally licensed on-site sewage designer for the infiltration test pit, soil test pit and soil boring recommendations for initial assessment (on-site sewage designer allowed only for projects subject to MR I-5). A more detailed soil and infiltration capacity assessment may be necessary once the preliminary site layout with location of LID stormwater controls is determined.

The methods in Section 2.2 are used to determine the measured saturated hydraulic conductivity rate for subgrade soil profile (existing) soils for overall site assessment and for beneath bioretention areas

and permeable pavement. The measured saturated hydraulic conductivity with no correction factor may be used as the design infiltration rate if the qualified professional engineer deems the infiltration testing described below (and perhaps additional tests) are conducted in locations and at adequate frequency capable of producing a soil profile characterization that fully represents the infiltration capability where the bioretention or permeable pavement areas are located (e.g., if the small-scale PITs are performed for all bioretention areas and the site soils are adequately homogeneous).

If deemed necessary by a qualified professional engineer, a correction factor may be applied to the measured saturated hydraulic conductivity to determine the design infiltration rate. Whether or not a correction factor is applied and the specific number used will depend on heterogeneity of the site soils and number of infiltration tests in relation to the number and type of infiltration areas. The overlying bioretention soil media provides excellent protection for the underlying native soil from sedimentation; accordingly, the underlying soil does not require a correction factor for influent control and potential clogging over time.

For recommendations on test frequency and correction factors specific to bioretention, see Section 6.1.2.1: Determining subgrade and bioretention soil media design infiltration rates. For recommendations on test frequency and correction factors specific to permeable pavement, see Determining subgrade infiltration rates under Section 6.3.2.1: Common components, design and construction criteria for permeable pavement systems.

The depth and number of test holes or test pits and samples should be increased if, in the judgment of the licensed certified soils professional, conditions are highly variable and such increases are necessary to accurately estimate the performance of the infiltration system. Qualified soils professionals include: certified soil scientists, professional engineers, geologists, hydrogeologists or engineering geologists registered in the State of Washington (or suitably trained persons working under the supervision of the above

professionals or by a locally licensed on-site sewage designer acceptable to the local jurisdiction). (On-site sewage designer allowed only for projects subject to MR I-5). The exploration program may also be decreased if, in the opinion of the licensed certified soils professional, the conditions are relatively uniform and omitting the test pits or borings will not influence the design or successful operation of the facility. In high water table sites, the subsurface exploration sampling need not be conducted lower than two feet below the groundwater table.

Prepare detailed logs for each test pit or test hole and a map showing the location of the test pits or test holes. Logs must include, at a minimum: depth of pit or hole, soil descriptions, depth to water, and presence of stratification. Logs must substantiate whether stratification does or does not exist. The certified soils professional may consider additional methods of analysis to substantiate the presence of stratification that may influence the design or successful operation of the facility.

Soil stratigraphy should also be assessed for low permeability layers, highly permeable sand/gravel layers, depth to groundwater, and other soil structure variability necessary to assess subsurface flow patterns. Soil characterization for each soil unit (soil strata with the same texture, color, density, compaction, consolidation and permeability) should include:

- Grain size distribution.
- Textural class.
- Percent clay content.
- Cation exchange capacity.
- Color/mottling.
- Variations and nature of stratification.

If the ground water in the area is known to be less than 5 feet below the proposed LID facility, the ground water regime should be assessed. At a minimum, ground water monitoring wells should be installed to determine groundwater depth and seasonal variations, considering both confined and unconfined aquifers. Monitoring through at least one wet season is required, unless site historical data regarding groundwater levels is available.

2

2.2 Soil & Subsurface Hydrology Characterization

If on-site infiltration may result in shallow lateral flow (interflow) the conveyance and possible locations where that interflow may re-emerge should be assessed by a certified soil scientist, professional engineer, geologist, hydrogeologist or engineering geologist registered in the State of Washington (or suitably trained persons working under the supervision of the above professionals or by a locally licensed on-site sewage designer). In general, a minimum of three wells associated with three hydraulically connected surface or ground water features are needed to determine the direction of flow and gradient. Alternative means of establishing the groundwater levels may be considered. If the groundwater in the area is known to be greater than 5 feet below the proposed LID facility, detailed investigation of the groundwater regime is not necessary.

Special considerations are necessary for highly permeable gravel areas. Signs of high groundwater will likely not be present in gravel lacking finer grain material such as sand and silt. Test pit and monitoring wells may not show high groundwater levels during low precipitation years. Accordingly, sound professional judgment, considering these factors and water quality treatment needs, is required to design multiple and dispersed infiltration facilities on sites with gravel deposits (personal communication Larry West).

If a single bioretention facility serves a drainage area exceeding 1 acre and the depth to a hydraulic restricting layer from the bottom (subgrade) of the bioretention area is less than 15 feet, a groundwater mounding analysis should be done in accordance with Volume III, Section 3.3 of the *SWMMWW*. Specific tests are determined by site conditions, the type of LID infiltration practice and project type.

2.2.1 Soil and Subsurface Hydrology Characterization Test Methods

1. In-situ small-scale pilot infiltration test method

The small-scale and large-scale PITs are similar; however the small-scale PIT reduces cost and test time and is appropriate for LID facilities that (when designed properly) have lower hydraulic loads. PITs provide the advantage of in-situ field test procedures that approximate saturated conditions and allow inspection of soil stratigraphy beneath the infiltration test. The test method is the following:

- Excavate the test pit to the estimated elevation at which the imported bioretention soil media will lie on top of the underlying native soil. The side slopes may be laid back sufficiently to avoid caving and erosion during the test. However, the side slopes for the depth of ponding during the test (6"-12") should be vertical.
- The horizontal surface area of the bottom of the test pit should be 12-32 square feet. The pit may be circular or rectangular, but accurately document the size and geometry of the test pit.
- Install a vertical measuring rod adequate to measure the full ponded water depth and marked in half-inch or centimeter increments in the center of the pit bottom.
- Use a rigid pipe with a splash plate on the bottom to convey water to the pit and reduce side-wall erosion or excessive disturbance of the pond bottom. Excessive erosion and bottom disturbance will result in clogging of the infiltration receptor and yield lower than actual infiltration rates. Use a 3-inch pipe for pits on the smaller end of the recommended surface area and a 4-inch pipe for pits on the larger end of the recommended surface area.
- Pre-soak period: add water to the pit so there is standing water for at least 6 hours. Maintain the pre-soak water level at least 12 inches above the bottom of the pit.
- At the end of the pre-soak period, add water to the pit at a rate that will maintain a 6-12 inch water level above the bottom of the pit over a full hour. The specific depth should be the same as

the maximum designed ponding depth (usually 6-12 inches).

- Every 15 minutes, record the cumulative volume and instantaneous flow rate in gallons per minute necessary to maintain the water level at the same point on the measuring rod.
- After one hour, turn off the water and record the rate of infiltration in inches per hour from the measuring rod data until the pit is empty.
- A self-logging pressure sensor may also be used to determine water depth and drain-down.
- At the conclusion of testing, over-excavate the pit to see if the test water is mounded on shallow restrictive layers or if it has continued to flow deep into the subsurface. The depth of excavation varies depending on soil type and depth to hydraulic restricting layer, and is determined by the engineer or certified soils professional.
- Data Analysis:
 - » Calculate and record the saturated hydraulic conductivity in inches per hour in 30-minute or one-hour increments until one hour after the flow has stabilized.
 - » Use statistical/trend analysis to obtain the hourly flow rate when the flow stabilizes. This would be the lowest hourly flow rate.
 - » Apply appropriate correction factors to determine the site-specific design infiltration rate (see Table 6.1.1 for bioretention correction factors and Table 6.3.2 for permeable pavement correction factors).

2. Soil grain size analysis method

The soil grain size analysis method can be used if the site has soils unconsolidated by glacial advance.

- Grain size should be analyzed for each defined layer below the top of the final bioretention area subgrade to a depth of at least 3 times the maximum ponding depth, but not less than 3 feet.
- Estimate the saturated hydraulic conductivity in cm/sec using the following relationship (see Massmann 2003, and Massmann et al., 2003).

$$\log_{10}(K_{sat}) = -1.57 + 1.90D_{10} + 0.015D_{60} - 0.013D_{90} - 2.08f_{fines}$$

Where, D_{10} , D_{60} and D_{90} are the grain sizes in mm for which 10 percent, 60 percent and 90 percent of the

sample is more fine and f_{fines} is the fraction of the soil (by weight) that passes the number 200 sieve (K_{sat} is in cm/s).

- If the licensed professional conducting the investigation determines that deeper layers will influence the rate of infiltration for the bioretention area, soil layers at greater depths should be considered when assessing the site's hydraulic conductivity characteristics.
- Machinery or material stockpiles and associated compaction should not be allowed in infiltration areas. Equation 1 assumes minimal compaction consistent with the use of tracked (i.e., low to moderate ground pressure) excavation equipment. If the soil layer being characterized has been exposed to heavy compaction, the hydraulic conductivity for the layer could be approximately an order of magnitude less than what would be estimated based on grain size characteristics alone (Pitt, 2003). In such cases, compaction effects must be taken into account when estimating hydraulic conductivity unless mitigated as determined by a licensed geotechnical engineer or engineering geologist. For clean, uniformly graded sands and gravels, the reduction in K_{sat} due to compaction will be much less than an order of magnitude. For well graded sands and gravels with moderate to high silt content, the reduction in K_{sat} will be close to



Large ring infiltration test
Source: Associated Earth Sciences

figure 2.1

an order of magnitude. For soils that contain clay, the reduction in K_{sat} could be greater than an order of magnitude.

- Use the layer with the lowest saturated hydraulic conductivity to determine the measured hydraulic conductivity.
- Apply appropriate correction factors to determine the site-specific design infiltration rate (see Table 6.1.1 for bioretention correction factors and Table 6.3.2 for permeable pavement correction factors).

3. In-situ large-scale Pilot Infiltration Test (PIT) method

Large-scale in-situ PIT described below is the preferred method for measuring the saturated hydraulic conductivity of the soil profile beneath large-scale permeable pavement facilities where stormwater from adjacent impervious surfaces is directed to the pavement surface resulting in higher hydraulic loads. The test method is the following:

- Excavate the test pit to the estimated surface elevation of the proposed infiltration facility. Lay back the slopes sufficiently to avoid caving and erosion during the test. Alternatively, consider shoring the sides of the test pit.
- The horizontal surface area of the bottom of the test pit should be approximately 100 square feet. Accurately document the size and geometry of the test pit.
- Install a vertical measuring rod (minimum 5 feet) marked in half-inch or centimeter increments in the center of the pit bottom.
- Use a rigid 6-inch diameter pipe with a splash plate on the bottom to convey water to the pit and reduce side wall erosion or excessive disturbance of the pond bottom.
- Add water to the pit at a rate that will maintain a water level between 6 and 12 inches above the bottom of the pit. Various meters can be used to measure the flow rate into the pit, including (but not limited to) rota- and magnetic meters. The specific depth should be the same as the maximum designed ponding depth (usually 6-12 inches).
- Every 15-30 minutes, record the cumulative volume and instantaneous flow rate in gallons per minute necessary to maintain the water level at the same point on the measuring rod.
- Keep adding water to the pit until one hour after the flow rate into the pit has stabilized while maintaining the same pond water level. A stabilized flow rate should have a variation of 5 percent or less in the total flow. The total of the pre-soak time plus the one hour after the flow rate has stabilized should be no less than six hours.
- After the flow rate has stabilized for at least one hour, turn off the water and record the rate of infiltration in inches per hour or centimeters per hour from the measuring rod data, until the pit is empty. Consider running this falling head phase of the test several times to estimate the dependency of infiltration rate with head.
- At the conclusion of testing, over-excavate the pit to see if the test water is mounded on shallow restrictive layers or if it has continued to flow deep into the subsurface. The depth of excavation varies depending on soil type and depth to hydraulic restricting layer, and is determined by the engineer or certified soils professional. Mounding is an indication that a mounding analysis is necessary.
- Data Analysis:
 - » Calculate and record the saturated hydraulic conductivity in inches per hour in 30-minute or one-hour increments until one hour after the flow has stabilized.
 - » Use statistical/trend analysis to obtain the hourly flow rate when the flow stabilizes. This would be the lowest hourly flow rate.
 - » Apply appropriate correction factors to determine the site-specific design infiltration rate (see Table 6.1.1 for bioretention correction factors and Table 6.3.2 for permeable pavement correction factors).

2.3 Hydrologic Patterns and Features

Hydrology is a central design element that is integrated into the LID process at the initial site assessment and planning phase. Utilizing hydrology as a design element begins by identifying and maintaining on-site hydrologic processes, patterns and physical features (streams, wetlands, native soils and vegetation, etc.) that influence those patterns.

Inventory and assessment

In addition to identifying the prominent hydrologic features, additional analysis will likely be required to adequately assess water movement over and through the site including:

- Identify and map minor hydrologic features including seeps, springs, closed depression areas, and drainage swales.
- Identify and map surface flow patterns during wet periods, and identify signs of duration and energy of storm flows including vegetation composition, and erosion and deposition patterns.

If seasonally high groundwater is suspected and soil test pits do not provide sufficient information to determine depth to ground water, map groundwater table height and subsurface flow patterns in proposed development, infiltration, and dispersion areas using shallow monitoring wells. In many sites, shallow hand-augured monitoring wells can be installed at low cost. See Section 2.2: Soil and subsurface hydrology characterization for detailed test descriptions.

For management of on-site hydrologic features see section 2.6: Riparian Management Areas, Chapter 1: Introduction, Chapter 3: Site Planning and Layout, and Chapter 5: Precision Site Preparation and Construction.

2.4 Native Forest and Soil Protection Areas

The conservation and use of on-site native soil and vegetation for stormwater management is a central principle of LID design. Protecting these features accomplishes three objectives:

1. Reduces total impervious area.
2. Maintains stormwater storage, infiltration, and evaporation.
3. Provides potential dispersion areas for stormwater. In addition to maintaining natural hydrologic processes, forest protection can provide other benefits including critical habitat buffers, open space, and recreation opportunity.

Inventory and Assessment

The following are steps to conduct a basic inventory and assessment of the function and value of on-site native vegetation:

- Identify any forest areas on the site and identify species and condition of ground cover and shrub layer, as well as tree species, condition, seral stage, and canopy cover.
- Identify underlying soils using soil pits and soil grain analysis to assess infiltration capability. See Soil Analysis section above and consult a geotechnical engineer for site-specific analysis recommendations.

Soil surveys and vegetation surveys are necessary to determine baseline conditions, establish long-term management strategies, and determine appropriate application of dispersion techniques if stormwater is directed to the protection area.

For management of native soil and vegetation protection areas, see Chapters 4: Vegetation and Soil Protection, Reforestation and Maintenance and Chapter 5: Precision Site Preparation and Construction.

2 2.5 Wetland

2.5 Wetlands

Determining appropriate assessment and management protocols for wetlands requires clear goals and objectives as well as evaluation of current conditions (if disturbed) and estimates of pre-development conditions. Appropriate goals and objectives are determined through the development application process and involve government permitting entities, consultants and the developer. Core assessment and management objectives for a project that is in a drainage basin with a wetland designated as high quality and sensitive and not used as flow control or treatment should include:

1. Protect native riparian vegetation and soils.
2. Protect diverse native wetland habitat characteristics to support the native assemblage of wetland biota.
3. Maintain or approximate pre-development hydrology and **hydroperiods** within the wetland.

Inventory and Assessment

The following steps should be used as a starting point to adequately inventory and provide an assessment of wetlands:

- Identify wetland category using local jurisdiction regulations and/or Ecology's *Washington State Wetlands Rating System for Western Washington*.
- Criteria (including wetland category) to determine if a wetland is or is not suitable to serve as a treatment or flow control facility is available in Appendix 1-D Guide Sheet 1 and 2 of Ecology's 2012 *SWMMWW*.

Ecology guidance for wetlands protection includes Category 1 and 2 wetlands and Category 3 wetlands that have a habitat score of 20 or more as high quality and sensitive. If the project is within the drainage area for a wetland that can be considered for structural or hydrological modification (see guide sheets 1 and 2 in Appendix 1-D of the *SWMMWW*), then the development may incorporate use of the wetland into the stormwater management strategy. Ecology recommends use of guide sheets 3A, 3B, and 3C in Appendix 1-D of the 2012 *SWMMWW* for wetland protection guidelines.

Management

Guidelines to prevent or minimize changes to wetland ecological structure and function are available in Appendix 1-D guide sheets 3A and 3B of Ecology's 2012 *SWMMWW*. The intent of the management strategies in the above guidelines is to achieve the goals identified in *Wetlands and Urbanization, Implications for the Future* (Azous and Horner, 2001).

Current hydrologic models do not adequately account for hydrodynamics in wetlands; accordingly, the guidelines presented in guide sheets 3A and 3B assess and control flow inputs to wetlands. Below are hydroperiod guidelines used previously in Puget Sound to protect wetland ecological function developed through the Puget Sound Wetland and Stormwater Research Program. These guidelines are provided as background information for the site assessment process and include:

- The increase or decrease of the pre-development mean monthly water level fluctuations should be maintained to less than 5 inches.
- The increase or decrease of 6 inches or more to the pre-development water level fluctuation should be restricted to less than 6 times during an average year.
- The duration of **stage excursions** of 6 inches or more above or below the pre-development water level fluctuations should not exceed 72 hours per excursion.
- Do not allow the total dry period (when pools dry down to the soil surface everywhere in the wetland) to increase or decrease by more than two weeks in any year.
- For priority peat wetlands, the duration of stage excursions above or below the pre-development water level fluctuations should not exceed 24 hours in a year.
- For wetlands inhabited by breeding amphibians, increases or decreases in pre-development water level fluctuations should not exceed 3 inches for more than 24 hours in any 30-day period. (Azous and Horner, 2001)
- Designate buffer widths consistent with best available science (see Washington State Department of Community, Trade and Economic Development Critical Areas Assistance

Handbook, 2003 and Citations of Recommended Sources of Best Available Science, 2002).

- Map wetlands and wetland buffer areas on all plans and delineate these areas on the site with fencing to protect soils and vegetation from construction damage. Fencing should provide a strong physical and visual barrier of high strength plastic or metal and be a minimum of 3-4 feet (see Ecology 2012 SMMWW BMP C103). Silt fencing, or preferably a compost berm, is necessary in addition to, or incorporated with, the barrier for erosion control.
- Install signs to identify and explain the use and management of the natural resource protection areas.
- See Riparian Management Areas section below for additional management strategies within buffer areas.

2.6 Riparian Management Areas (RMA)

Riparian zones are defined as areas adjacent to streams, lakes and ponds that support native vegetation adapted to saturated or moderately saturated soil conditions. If there is adequate mature vegetation, land-form, and large woody debris then riparian areas:

- Dissipate stream energy and erosion associated with high flow events.
- Filter sediment, capture bedload, and aid in floodplain development.
- Improve flood water retention and groundwater recharge.
- Develop diverse ponding and channel characteristics that provide habitat necessary for fish and other aquatic life to spawn, feed and find refuge from flood events.
- Provide vegetation litter and nutrients to the aquatic food web.
- Provide habitat for a high diversity of terrestrial and aquatic biota.
- Provide shade and temperature regulation.
- Provide adequate soil structure, vegetation and surface roughness to slow and infiltrate stormwater delivered as precipitation or low velocity sheet flow from adjacent areas (Prichard et al., 1998).

Adequately sized and maintained riparian management areas can protect streams, lakes and wetland areas from some impacts of surrounding urbanization as well as supply nutrients and materials to support healthy aquatic ecosystems.

Inventory and Assessment

The objective for riparian area assessment and management is to protect, maintain and restore mature native vegetation cover that provides the above functions and structures. See sections 2.5: Wetlands, 2.8: Floodplains, and Chapter 4: Vegetation and Soil Protection and Reforestation for assessing the extent and quality of the RMAs in various settings.

Management

Riparian management areas are used to buffer streams, lakes, wetlands and other aquatic resources from adjacent land disturbance. While RMAs are typically maintained to protect soils, vegetation cover, and stable landforms to buffer aquatic resources, managing overland stormwater flows from adjacent development is not the primary function of these areas. However, if the riparian area will receive storm flow, the following minimum riparian buffer design criteria are recommended to dissipate, infiltrate and remove pollutants from overland flow:

- Maintain overland flow as sheet flow and do not allow stormwater entering or within buffers to concentrate.
- Maintain (and restore if necessary) mature, native plant communities and soils within the buffer.
- Designate buffer widths consistent with best available science (see Washington State Department of Community, Trade and Economic Development Critical Areas Assistance Handbook, 2003 and Citations of Recommended Sources of Best Available Science, 2002).
- If buffer averaging is used, the following minimum site features and objectives should be considered when determining the extent of the buffer: soils, slope, vegetation, pollutant loads, water quantity and quality targets, and sensitivity of resource.

- Map RMAs on all plans and delineate with fencing to protect soils and vegetation from construction damage. Fencing should provide a strong physical and visual barrier of high strength plastic or metal and be a minimum of 3-4 feet high (see 2012 SWMMWW BMP C103). Silt fencing, or preferably a compost berm, is necessary in addition to, or incorporated with, the barrier for erosion control.
- Install signs to identify and explain the use and management of the natural resource protection areas.
- Buffers should include 100-year floodplain, wetlands and steep slopes adjacent to streams and the channel migration zone.
- Flow velocities reaching and within buffer areas should not exceed 1 ft/second.
- Unrestricted overland flow distance should not exceed 150 feet for pervious areas and 75 feet for impervious areas before reaching buffers (Schueler, 1995).
- Do not allow effective impervious surface within the buffer.
- Activity within the RMA should be limited to:
 - » Passive, confined recreation (e.g., walking and biking trails) constructed from pervious surfaces.
 - » Platforms for viewing streams, lakes and wetlands constructed with techniques to minimize disturbance to soils and vegetation.
- Establish a long-term management entity and strategy to maintain or enhance the structural integrity and capacity of the buffer to protect water quality and habitat.

2.7 Streams

Determining appropriate assessment and management protocols for stream channel corridors will require clear articulation of goals and objectives. Appropriate goals and objectives will likely be determined through the development application process involving government permitting entities, consultants and the developer. If the project is within a watershed with streams designated as high quality and sensitive, objectives for assessment

and management strategies should include:

1. Protect mature native riparian vegetation and soils.
2. Protect diverse native stream habitat characteristics to support the native assemblage of stream life.
3. Maintain pre-development hydrology.

Inventory and Assessment

The following steps should be utilized as a starting point to adequately inventory and provide an assessment of any creeks, streams or rivers:

- Identify stream category by using Washington Department of Natural Resources water typing classification system (WAC 222-16-030).
- Identify riparian area and fish and wildlife habitat requirements.
- Assess general stream corridor condition and determine if there is a need for more detailed assessment and specific management strategies.

Management

- Designate riparian management area widths according to best available science and local jurisdiction regulations.
- Map riparian management areas on all plans, and delineate riparian management areas on the site with silt, chain link or other appropriate fencing to protect soils and vegetation from construction damage.
- See Section 2.5: Riparian Management Area for additional management strategies.

2.8 Floodplains

The objective for floodplain area assessment and management is to maintain or restore:

1. The connection between the stream channel, floodplain and off channel habitat.
2. Mature native vegetation cover and soils.
3. Pre-development hydrology that supports the above functions, structures, and flood storage.

Inventory and Assessment

The following steps, at a minimum, should be used to inventory and provide an assessment of floodplain areas:

- Identify the 100-year floodplain and channel migration zone.
- Inventory composition and structure of vegetation within the floodplain area.
- Identify active channel.

Management

- Map the extent of the 100-year floodplain or channel migration zone on all plans and delineate these areas on the site with fencing to protect soils and vegetation from construction damage. Fencing should provide a strong physical and visual barrier of high strength plastic or metal and be a minimum of 3-4 feet high. Silt fencing, or preferably a compost berm, is necessary in addition to, or incorporated with, the barrier for erosion control.
- See Section 2.6: Riparian Management Areas for additional management strategies.

- Install signs to identify and explain the use and management of the natural resource protection areas.

A project should not be considered low impact development if it is located within the 100-year floodplain or channel migration zone.

2.9 Sub-basin Delineation

Stormwater management in the LID context is based on a distributed approach. The project site and most importantly the development envelope is divided into sub-basins or small contributing areas that are managed by small-scale hydrologic and water quality treatment practices (see figure 2.2). This approach provides several advantages, some of which include:

- Individual practices receive smaller hydraulic and pollutant loads.
- Small-scale practices can be arranged in the project efficiently and save space for other amenities compared to large ponds.
- LID practices can be designed into the project as community amenities.

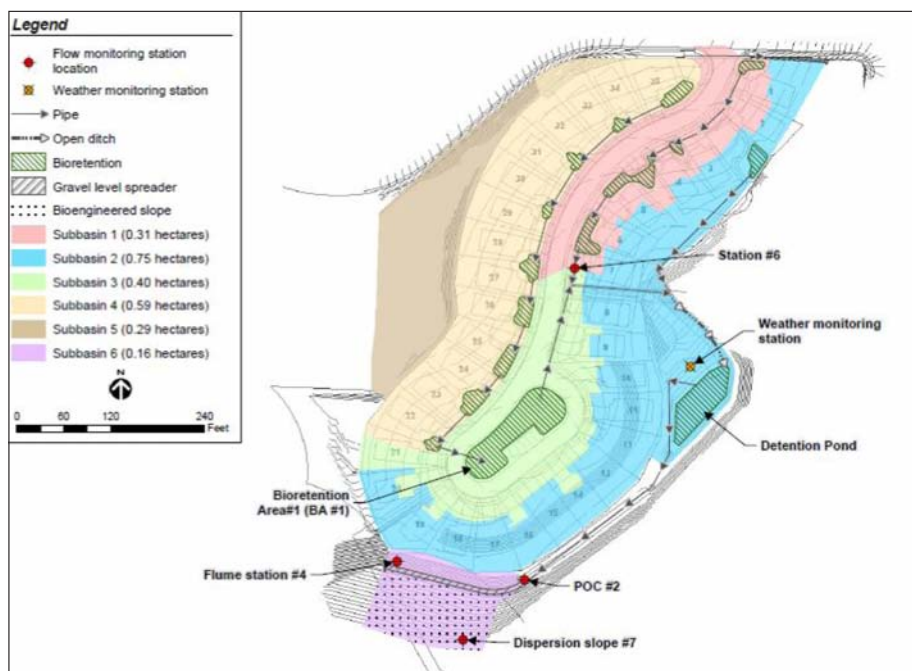

Contributing area delineation for designing small-scale, distributed stormwater management approach
Source: Hinman 2009

figure 2.2

2.10 Site Mapping Process

2.10 Site Mapping Process

Through the assessment process, map layers are produced to delineate important site features. The map layers are combined to provide a composite site analysis and guide the road layout and overall location and configuration of the development envelope(s). This site assessment and mapping process can be used for

any development type including dense residential with small lots (see figure 2.3) and large lot residential (see figure 2.4). See Chapter 3: Site Planning and Layout for details on utilizing assessment information for site design.

figure 2.3

Site analysis map layers and composite map
Source: AHBL

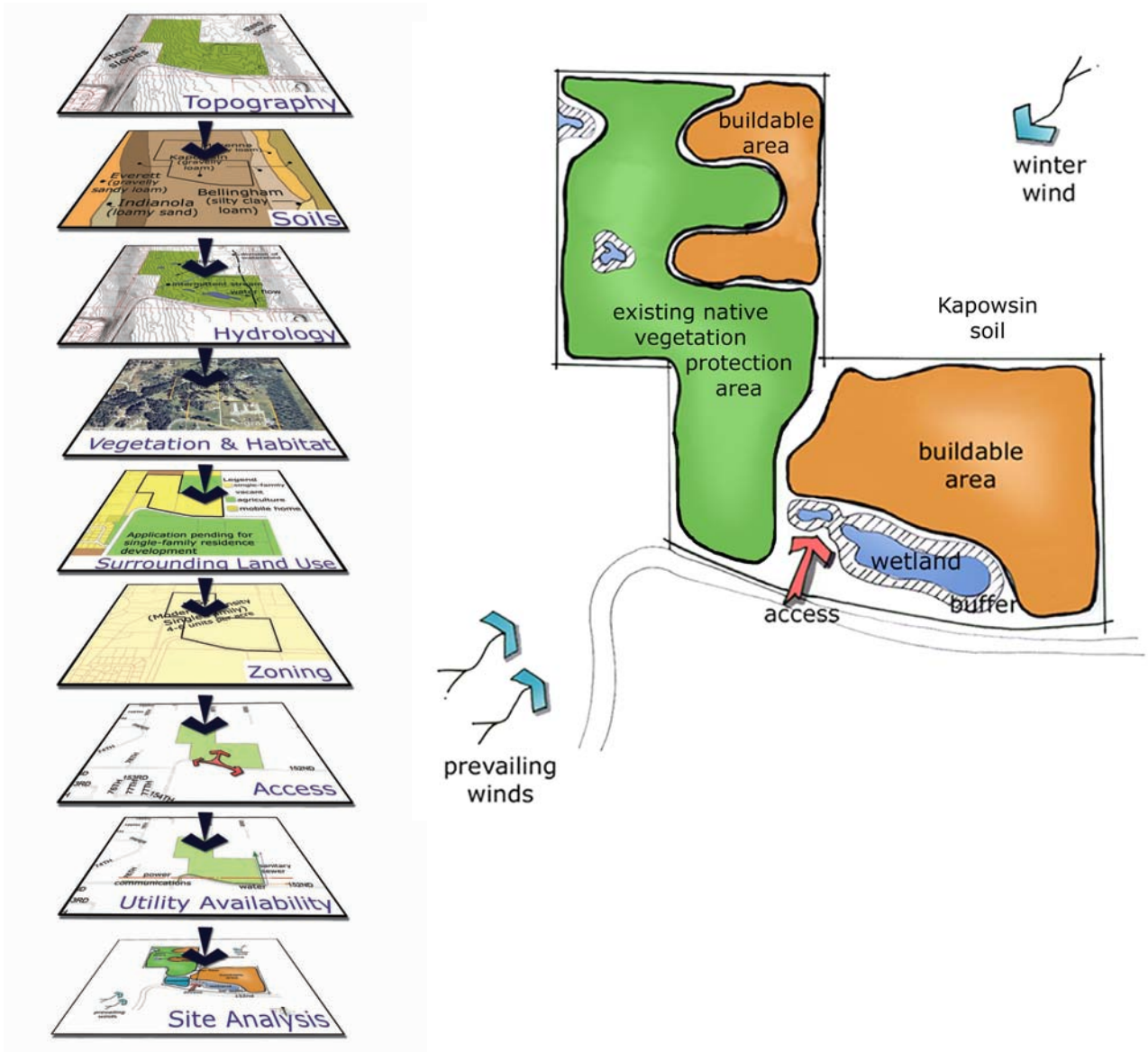

figure 2.4

Large lot composite site analysis.
Source: AHBL



THIS PAGE
INTENTIONALLY
LEFT BLANK

Site Planning & Layout

3

CHAPTER

- Urban Redevelopment and Infill 3.1
- New Suburban Development 3.2
- Commercial Development 3.3
- Road Crossings 3.4

Site assessment and site planning are iterative processes. Existing and native environmental conditions strongly influence the extent and location of the development envelope for an LID project. The regulatory, market and architectural context of the location are integrated with the site assessment findings to produce a road and lot configuration that strategically uses site features for minimizing and isolating impervious surfaces and dispersing and infiltrating storm flows. As site planning progresses and details for roads, structures and LID practices are considered, site designers may need to evaluate additional site conditions.

“Regulatory, market and architectural considerations are combined with the site assessment to produce a site design that strategically uses site features to minimize and isolate impervious surfaces and disperse and infiltrate storm flows.”

3

3.0 Site Planning & Layout

Context is essential for developing any successful residential or commercial project. The designer must consider the appropriate plat design, housing type or commercial building given the existing character and possible future conditions. Architectural considerations and the mix of land use types (e.g., commercial and residential mixed use) influence how the project integrates with the surroundings while at the same time creating neighborhood identity (personal communication Len Zickler, January 2004). A low impact development project incorporates these same design considerations; however, the following stormwater and other environmental management elements are elevated to equal standing:

- Hydrology is an organizing principle of the site layout and is integrated into the initial site assessment and planning phases.
- Individual LID practices are distributed throughout the project site and influence the configuration of roads, house lots, and other infrastructure.
- LID practices are amenities that provide multiple functions, including aesthetic landscaping, visual breaks that increase a sense of privacy within a variety of housing densities, and a design element (of equal importance to architectural and plat design) that promotes neighborhood identity.

Density and Stormwater Management

Density within the context of regional and site planning has a very significant impact on stormwater management. Recent modeling studies suggest that increasing density is the most effective management strategy for reducing stormwater volume and associated pollutant loads per building. Jacob and Lopez (2009) found that doubling typical suburban densities to 8 dwelling units per acre did more to reduce volume and pollutant loads than most conventional BMPs, and at 64 dwelling units per acre, volume and pollutant loads were reduced more than essentially all conventional BMP scenarios (population held constant). EPA (2006) also found that higher density scenarios generated less impervious cover and less stormwater runoff at the parcel and watershed scale. When coupled with sound open space, stream and wetland protection, reducing green field development and sprawl is a critical tool

for protecting receiving waters. Given these and other community benefits that come from more compact growth and that the GMA promotes development in urban cores, this chapter focuses largely on techniques to manage stormwater on small lots and higher density scenarios.

Regulatory Context

The configuration of lots, the location of structures on parcels, road widths and other site layout considerations are influenced by several local codes and standards, including:

- Comprehensive Plan Goals and Policies
- Zoning Code
 - » Landscaping, Native Vegetation, Tree Protection, and Open Space
 - » Impervious Surface Standards
 - » Bulk and Dimensional Standards
 - » Site Plan Review
 - » Parking
- Development Code and Standards
 - » Clearing and Grading Standards
 - » Engineering and Street Standards

There may be language within these codes and standards that discourages or prohibits LID strategies. For example, existing lot setback, street width standards, parking requirements, and density standards may lead to excessive impervious surface coverage. Integrating new codes and standards that allow or require LID practices and improve stormwater management is not the subject of this manual; however, guidance for integrating LID requirements into local codes and standards is available in *Integrating LID into Local Codes: A Guidebook for Local Governments* (Puget Sound Partnership, 2012).

Initial Delineation and Site Management

Assessment of natural resources outlined in the previous section will produce a site plan with a series of maps identifying streams, lakes, wetlands, buffers, steep slopes and other hazard areas, significant wildlife habitat areas, existing utilities and setbacks, and permeable soils offering the best potential for infiltration. Maps can be combined as GIS or CAD

layers to delineate the best areas to direct development. Building sites, road layout and stormwater infrastructure should be configured within these development areas to minimize soil and vegetation disturbance and take advantage of a site's natural stormwater processing capabilities. Initial delineation and site management strategies include:

- Establish limits of disturbance to the minimum area required for roads, utilities, building pads, landscape areas, and the smallest additional area needed to maneuver construction equipment.
- Map and delineate natural resource protection areas with appropriate fencing and signage to provide protection from construction activities.
- Meet and walk the property with the owner, engineers, landscape architects, and others directing project design to identify problems and concerns that should be evaluated for implementing the site plan.
- Meet and walk the property with equipment operators prior to clearing and grading to clarify construction boundaries and limits of disturbance (see Chapter 4: Vegetation and Soil Protection and Reforestation, and Chapter 5: Precision Site Preparation and Construction for more detailed information).

This chapter is organized into three main categories: (1) urban redevelopment and infill; (2) new suburban development; and (3) commercial development. The first two categories are further divided into two sections that examine: (a) roads, driveways and parking; and (b) housing type, mixed use and lot layout. The third category, commercial, focuses on parking. The chapter concludes with a discussion of road crossings.

3.1 Urban Redevelopment and Infill

Infill development is the process of developing vacant or under-used parcels within existing urban areas that are already largely developed. Infill takes advantage of, and improves the tax base for, existing infrastructure and services including various transportation modes, sewer, water, and power. Other benefits can accrue with development in urban core areas by reducing transportation impacts and creating more vibrant neighborhoods with a mix of housing types closer to services and employment (MRSC, 1997).

While the socio-economic benefits of infill can be significant, the reduction of green field and sensitive area conversion is one of the most effective stormwater management strategies for protecting streams, lakes and wetlands. Under conventional land use development the population increased by 36 percent in the Puget Sound region between 1970 and 1990. During the same period, the amount of developed land increased by 87 percent (Pivo and Lidman, 1990). In the Puget Sound lowlands most precipitation is transformed to evapo-transpiration (ET) or groundwater flow with 1 percent or less reaching fresh water as overland flow. Estimates for typical suburban overland flow range from 30-40 percent. As a result, reducing land development and using existing converted land in urban cores is one of the most cost-effective stormwater volume reduction tools.

Stormwater regulations for infill need to provide adequate flow and water quality treatment requirements without unintentionally discouraging infill. Area available for stormwater storage, infiltration and treatment in denser development is also limited. However, opportunities in roadways, parking areas, building sites, and the building envelope do exist to improve existing conditions in urban settings.

3

3.1 Urban Redevelopment & Infill

3.1.1 Roads, Driveways and Parking

The overall objectives for LID redevelopment and infill road designs are:

- Reduce **total impervious area** (TIA) by reducing pavement coverage.
- Minimize EIA and concentrated surface flows on impervious surfaces by reducing or eliminating hardened conveyance structures (pipes or curbs and gutters).
- Infiltrate or slowly convey storm flows in roadside bioretention cells and swales, and through permeable paving and aggregate storage systems under the pavement. Note that if using infiltration and/or conveyance under roads and parking areas in a retrofit setting the design must consider the integrity and protection of adjacent infrastructure.
- Slow and filter storm flows through bioretention planters.
- Incorporate trees and adequate planting soil galleries in the streetscape.
- Create connected street patterns to promote walking, biking and access to transit and services as well as provide efficient fire and safety vehicle access.
- Create and use open space areas as a community amenity and to store and slow storm flows during the winter when the areas are less active.

Road Layout and Streetscape

In developed urban cores, road layout is often set within the historic development pattern. However, several design strategies within an existing streetscape are possible for improving stormwater management and enhancing community character:

- Bioretention in traffic calming designs and other open space associated with roadways (see figure 3.1).
- Bioretention planters and trees in sidewalks and promenades (see figure 3.3). See Section 6.1: Bioretention for design details.
- Permeable pavement in parking areas and bioretention in parking lot landscape islands.

- Permeable pavement with subsurface engineered soil systems surrounding newly planted trees providing soil volume and sustained root development in a manner compatible with pavement and other subsurface infrastructure (see figure 3.2). See Section 6.4: Urban Trees and Section 6.3: Permeable Pavement for design details.



figure 3.1

The Siskiyou Street project in Portland, Oregon uses traffic calming designs to reduce vehicle speeds, improve safety and manage stormwater. Note curb cuts that allow stormwater to enter bioretention area. *Source: Photo by Erica Guttman*



figure 3.2

Bioretention and subsurface engineered soil systems to support healthy trees are integrated into this Shoreline, Washington project to manage stormwater in a dense urban environment. *Source: Photo by Otak*



figure 3.3

This Portland, Oregon project uses bioretention planters to integrate stormwater into an ultra-urban setting.
 Source: Photo by Curtis Hinman
 Illustration: AHBL

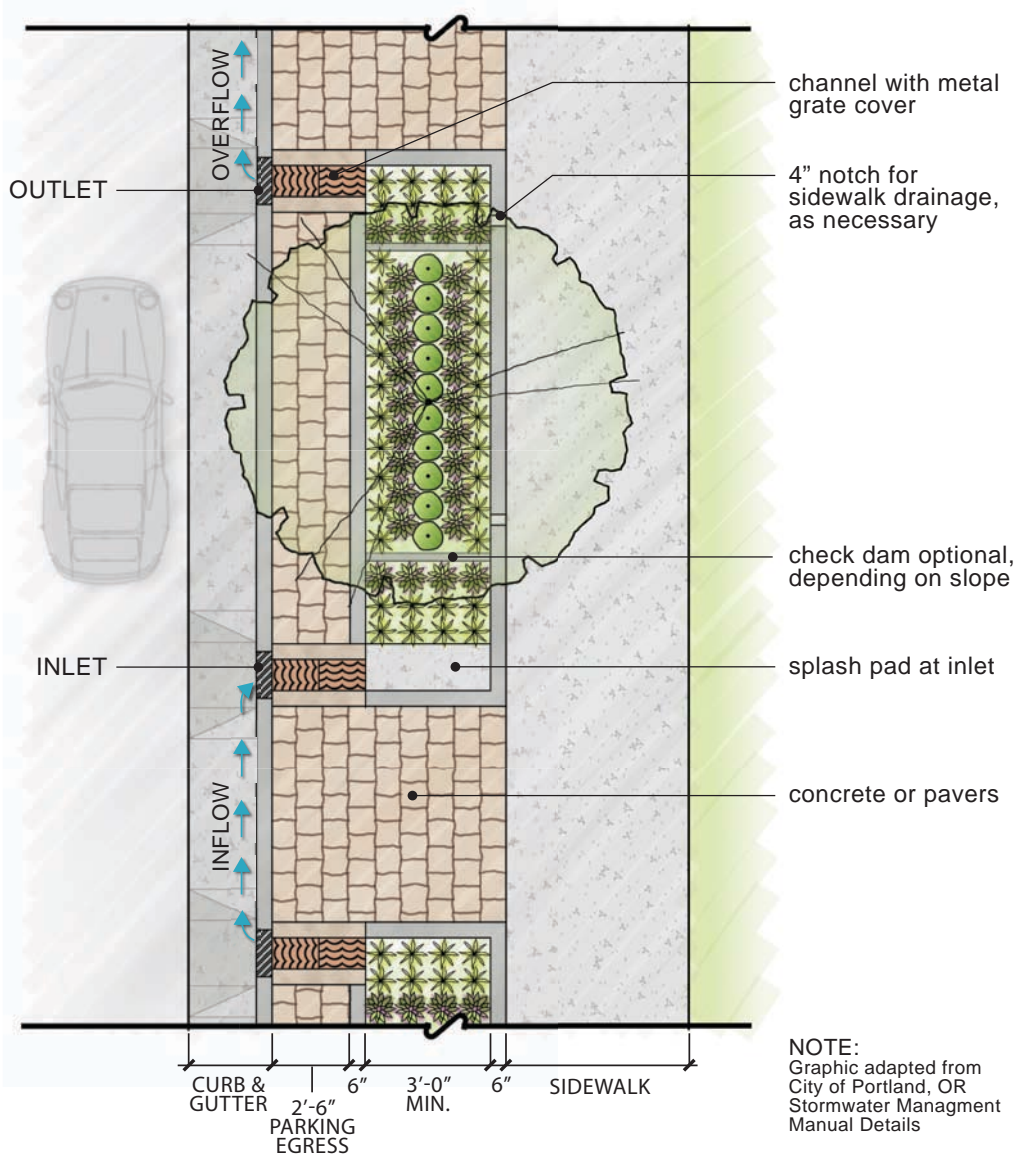

3

3.1 Urban Redevelopment & Infill

The Sherbourne project (see figures 3.4 and 3.5) is a residential infill project designed with a loop road along home frontages that provides good access for residents as well as fire and safety vehicles. Open space in the center of the loop provides stormwater storage in the winter when the area is not used, a visual landscape

break for homes facing the road, and a creative example of integrating a regulatory requirement with a site amenity. For more strategies applicable to the road layout and width, sidewalks, driveways and parking see Section 3.2.1: Roads, Driveways and Parking for suburban development.

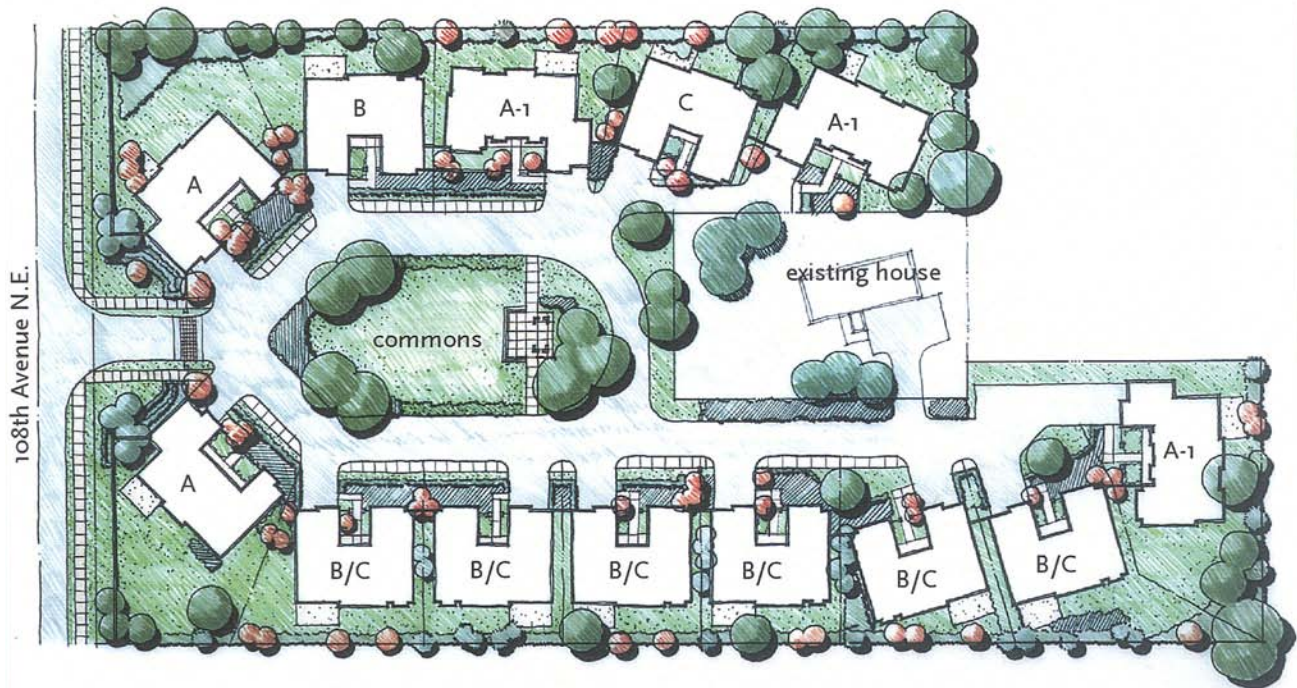

figure 3.4

Sherbourne project plan view.
Source: Mithun



figure 3.5

Combined commons and stormwater
facility at Sherbourne.
Source: Photo by Colleen Owen

Alleys

Alleys should be the minimum width required for service vehicles, constructed of permeable paving materials and allow surface flows to disperse and infiltrate to adjacent bioretention swales, shoulders or yards. Strategies to reduce TIA associated with alleys include:

- Maximum alley width should be 10-12 feet with 14- to 16-foot right-of-ways respectively (see local jurisdiction code for specific alley width requirements).
- Several permeable paving materials are applicable for low speeds and high service vehicle weights typically found in alleys including:
 - » Permeable gravel paving systems.
 - » Permeable concrete.
 - » Permeable pavers.
 - » Systems integrating multiple permeable paving materials. (See figure 3.6)

See Section 6.3: Permeable Pavement for details.

3.1.2 Lot and Building Design

As density increases so does the percentage of surface flow associated with rooftops. At the same time, the available area to manage the roof water at the ground level decreases. Rainwater harvesting and green roofs are two strategies that are applicable for managing stormwater in the dense urban core, particularly for commercial or multifamily complexes. For more information on rain water collection see Section 6.7 and for vegetated roofs see Section 6.5.

Bioretention and permeable paving systems are highly adaptable and can provide significant stormwater management benefits in a variety of land use settings including the ultra-urban setting. Applicable strategies include bioretention cells or planters adjacent to or attached to the building (for more information on bioretention planters see Section 6.1) and permeable pavement courtyards and walkways. (See figures 3.7 and 3.8.) Permeable pavement can be particularly effective surrounding trees and associated subsurface planting soil structures (see Section 6.4: Urban Trees for more information).



figure 3.6

Vancouver, B.C. Country Lane alley uses a combination of concrete wheel strips, permeable pavers, reinforced plastic grid with grass and under-drains to attenuate storm flows and create an aesthetic design objective.
Source: Photo by Curtis Hinman

3

3.1 Urban Redevelopment & Infill



figure 3.7

Bioretention planters
(Portland State University, OR).
Source: Photo by Curtis Hinman



figure 3.8

Bioretention incorporated into the center of an apartment courtyard. This apartment complex was a used car sales lot. By incorporating LID into the redevelopment, stormwater management can be enhanced over the previous land use.
Source: Photo by Curtis Hinman

Preserving native soils and vegetation and incorporating LID practices in relatively dense residential infill is challenging, but achievable. Good site assessment, strategic design and careful construction sequencing are key processes for success. Particularly important in LID residential infill projects is to consider surrounding neighborhood character and design to integrate within that context. Danielson Grove provides a good case study for preserving native soils and vegetation and incorporating LID features in a dense residential infill project.

Project Case Study: Danielson Grove, Kirkland, WA

Low impact development practices applied at Danielson Grove:

Site Planning

- Clustering
- Use of open space
- Retained vegetation / soils
- Reduction of potable water use

Stormwater Management

- Reduction of impervious surfaces
- Use of amended top soil
- Bioretention
- Permeable pavement

Construction

- Shared infrastructure facilities
- Reduced grading impacts

Project Overview

Danielson Grove was completed in 2005 and built under the City of Kirkland's Innovative Housing Demonstration Project Ordinance. Sixteen cottage-style homes (700-1,500 square feet) are carefully arranged on individual fee simple lots ranging from 2,400-3,000 square feet. The project is located in an established traditional single-family residential neighborhood with lots ranging in size from 7,000-10,000 square feet. The total project site area is 2.25 acres, zoned R-7200, generally flat sloping to the west, with approximately 40 percent of the pre-development site covered with native coniferous trees and understory plant material.



DANIELSON GROVE Site Plan

Graphic by Triad Associates for The Cottage Company

figure 3.9

Danielson Grove site plan, common area and individual homes with preserved trees and bioretention swales between buildings.

Source: Triad Associates for The Cottage Company

3

3.1 Urban Redevelopment & Infill



figure 3.10

Danielson Grove - examples of common open space, clustering, and native vegetation retention.
Source: Source: Triad Associates for The Cottage Company

Site Planning

Danielson Grove was executed by a diverse design team consisting of the owner/builder, architect, civil engineer, landscape architect, geologist, arborist, governing jurisdiction, and contractor. The importance of building a broad-based team early in the conceptual planning process and working collaboratively to the end of construction cannot be overstated, particularly on infill redevelopment projects with increasing densities.

Creative clustering allowed the preservation of large, undisturbed open spaces and saved approximately 40 existing trees, compared to just six which would have been sufficient to meet tree retention requirements under existing zoning. One benefit of these saved trees is the creation of a visual buffer with adjacent neighbors. Views onto the site are filtered through the mature stands of existing vegetation. Also, scale and orientation of the cottages was selected to further reduce impacts to the existing neighborhood. This was accomplished by moving houses back from and reducing their height close to street edges. Adjacent to the most heavily traveled public roadway is a one-story community building that is visually inviting to pedestrians, but which also creates separation and privacy for the internal shared, common green space. Individual lot sizes and private outdoor space have been reduced in order to maximize retained vegetation and allow for larger areas of shared, common open

spaces. As a result, approximately 41 percent of the site is set aside as open space. Of this, 10 percent is undisturbed soils and vegetation, and 22 percent is set aside as common open space.

The cottages' front doors are organized around central common areas, helping to create safe, friendly and usable spaces. An important component in developing the community is the use of low, open fences along individual lot lines. These help separate and define public and private areas while allowing a visual connection. To strengthen the development of this tight-knit community even further, all garages are detached, with residents walking to their front doors through the common areas. This encourages personal interaction for all residents.

Parking is 1.5 stalls per unit, with each cottage having one assigned detached garage and sharing eight off-street stalls. In addition, there are approximately 25 on-street parking stalls available to the community and visitors. By detaching the garages, the cottages have smaller footprints, making them more human in scale, and preventing the internal street from being dominated by garage doors. In addition, on-street parking is more efficient due to the reduction in individual garage driveway cuts.

Creating Community

With its smaller footprint homes, network of paths, “out back” garages, and inviting common spaces, Danielson Grove fosters a sense of community by encouraging interaction among its residents. The low, informal fences separate community and private spaces while giving homeowners a sense of privacy and opportunity for individual expression.

This project defies its small size by offering its residents a variety of experiences. There is a hierarchy of exterior spaces – meandering walkways, expansive lawn and large outdoor plaza for community gatherings, as well as small patios and seating nooks for individual use.

Stormwater Management

A network of porous paths meander through retained vegetation allowing water to filter and cleanse through native soils and plant roots before entering the storm system. Attractively designed bio-filtration swales are strategically placed between buildings to collect and treat roof and surface runoff. These features dramatically extend the length of time stormwater remains on the site, improving water quality and maximizing opportunities for infiltration, plant uptake and evapotranspiration. Ultimately, drainage is conveyed to a detention vault buried beneath the centrally located community building and plaza. The vault provides flow control, mimicking pre-development conditions by slowly releasing drainage to the public receiving system. Porous pavers used in the plaza area allow stormwater to drain directly into the detention vault.



DANIELSON GROVE Sustainable Components Plan

Graphic by Triad Associates for The Cottage Company

figure 3.11

Danielson Grove site plan, common area and individual homes with preserved trees and bioretention swales between buildings.

Source: Triad Associates for The Cottage Company

3

3.1 Urban Redevelopment & Infill

The street right of way is 40 feet with a 22-foot section providing two traffic lanes and parking on one side. Instead of traditional concrete sidewalks on both sides of the public street, a single concrete sidewalk was constructed on one side of the street with a porous gravel walk on the other. Crushed gravel and porous concrete walkways were used under the existing conifer canopy to minimize root disturbance and maintain healthy root growth.

All non-retained planting areas incorporated approximately 12 inches of amended compost tilled deeply into the existing soil structure to improve moisture holding capacity and add nutrients. In order to minimize water use, water-wise native and locally naturalized plants were used extensively. In addition, irrigation needs were minimized by limiting the use of lawn primarily to the central commons area.

Construction

Grading impacts were reduced by careful upfront site planning with a focus on saving existing trees and minimizing soil disturbance. This was accomplished by reducing building foundation foot prints and co-locating utilities. Additionally, special attention was paid to matching existing grades. This minimized cuts and fills, reducing the amount of material needing to be hauled off or onto the site to establish design grades.

Utility infrastructure was designed to efficiently serve the project while minimizing site disturbance. Water and sewer lines were located only in areas that were already slated for disturbance. Water meters were clustered to minimize disturbance resulting from service line construction. Dry utilities were co-located under proposed sidewalks in joint trenches.

The Result

Danielson Grove is a neighborhood rich in detail, texture and vibrant color. The focus is on sensitivity to the environment and design for human scale and interaction. This combination results in a site that functions environmentally, socially and aesthetically.

Builder: The Cottage Company

Architect: Ross Chapin Architects

Civil Engineer: Triad Associates

Landscape Architect: Triad Associates

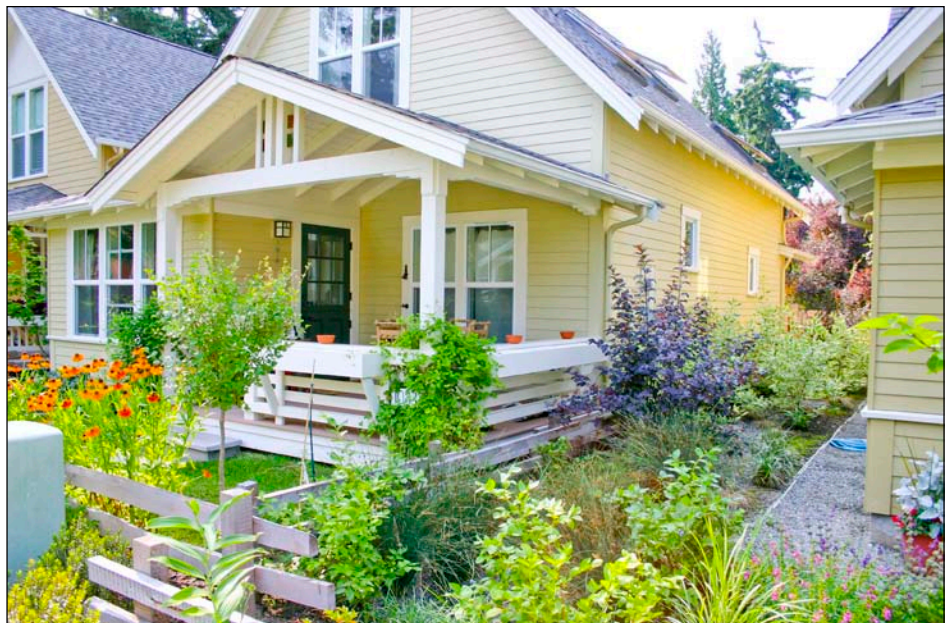

figure 3.12

Danielson Grove

Source: Triad Associates for The Cottage Company

3.2 New Suburban Development

The following applies to medium to high-density suburban settings, planned communities, and rural development.

3.2.1 Roads, Driveways and Parking

Residential roads in the early 1900s were primarily laid out in grid patterns to allow efficient access to services and transit, and were dominated by a mix of uses including pedestrian, bicycle and vehicle transportation. The grid configuration has evolved over the past century to modified grids and current prevailing designs that use curvilinear layouts with relatively disconnected loops and cul-de-sacs. The transition has been driven primarily by the increased mobility offered by the automobile and the perceived safety and privacy of dead end roads (Canadian Mortgage and Housing Corporation [CMHC], 2002).

At the national level, the American Association of State Highway and Transportation Officials (AASHTO) estimates that the urban and rural local access roads typically account for 65-80 percent of the total road network (AASHTO, 2001). Design standards for roads in residential areas focus on efficient and safe movement of traffic and rapid conveyance of stormwater. As a result, streets contribute higher storm flow volumes and pollutant loads to urban stormwater than any other source area in residential developments (City of Olympia, 1995 and Bannerman, Owens, Dodds and Hornewer, 1993).

Local access and small-collector road design is influenced at the individual parcel and subdivision scales and is the focus of this section. Road design is site specific; accordingly, this section does not recommend specific road designs. Instead, the strengths and weaknesses of different road layouts are examined in the context of LID to assist designers

“An analysis in south Puget Sound found that the transportation component of the suburban watershed accounts for approximately 60 percent of the total impervious area (City of Olympia, 1995).”

in the process of providing adequate transportation systems while reducing impervious surface coverage. The overall objectives for LID new suburban road designs are:

- Reduce TIA by reducing the overall road network coverage.
- Reduce stream crossings with efficient road network design.
- Minimize or eliminate EIA and concentrated surface flows on impervious surfaces by reducing or eliminating hardened conveyance structures (pipes or curbs and gutters).
- Infiltrate and slowly convey storm flows in roadside bioretention cells and swales and through permeable paving and aggregate storage systems under the pavement.
- Design the road network to minimize site disturbance, avoid sensitive areas and reduce fragmentation of landscape.
- Create connected street patterns to promote walking, biking and access to transit and services, as well as provide efficient fire and safety vehicle access.
- Create and use open space areas as a community amenity and to store and slow storm flows during the winter when the areas are less active.

3

3.2 New Suburban Development

Road Layout

The Urban Land Institute (ULI), Institute of Transportation Engineers (ITE), National Association of Home Builders, and American Society of Civil Engineers state in a 2001 collaborative publication that: “The movement of vehicles is only one of a residential street’s many functions. A residential street is also part of its neighborhood and provides a visual setting for the homes as well as a meeting place for residents.” Additionally, ULI recommends that the land area devoted to streets should be minimized (National Association of Home Builders [NAHB], American Society of Civil Engineers, Institute of Transportation

Engineers, and Urban Land Institute, 2001). These recommendations are derived primarily from a livability and safety perspective; however, the guidelines also integrate well with the low impact development design approach.

Designs for residential roads generally fall into three categories: grid, curvilinear and hybrids. Figures 3.13 and 3.14 illustrate the grid and curvilinear road layouts and Table 3.1 summarizes the strengths and weaknesses of the grid and curvilinear approaches.



figure 3.13

Typical grid road layout with alleys.
Source: AHBL

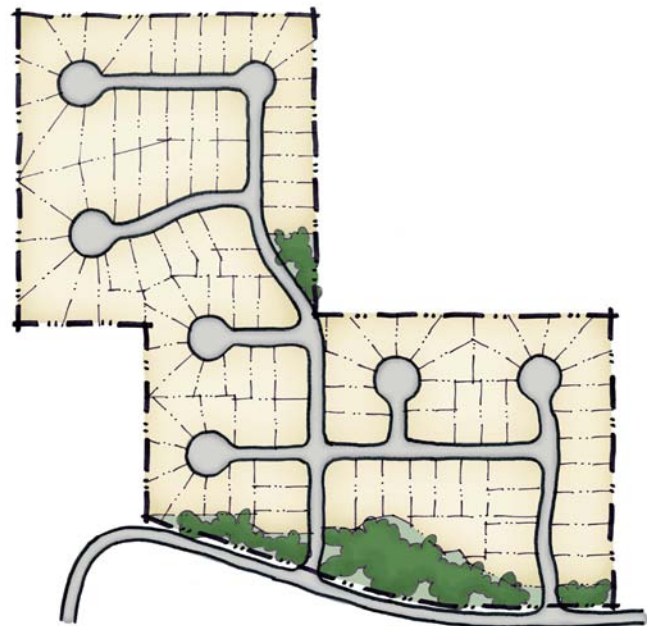

figure 3.14

Typical curvilinear road layout with cul-de-sacs.
Source: AHBL

table 3.1 Strengths and weaknesses of the grid and curvilinear approaches.

Road Pattern	Impervious Coverage	Site Disturbance	*Biking, Walking, Transit	Safety	Auto Efficiency
Grid	27-36% (Center for Housing Innovation, 2000 and CMHC, 2002)	less adaptive to site features and topography	promotes by more direct access to services and transit	may decrease by increasing traffic throughout residential area	more efficient - disperses traffic through multiple access points
Curvilinear	15-29% (Center for Housing Innovation, 2000 and CMHC, 2002)	more adaptive for avoiding natural features, and reducing cut and fill	generally discourages through longer, more confusing, and less connected system	may increase by reducing through traffic in dead end streets	less efficient - concentrates traffic through fewer access points and intersections

**Note: biking, walking and transit are included for livability issues and to reduce auto trips and associated pollutant contribution to receiving waters.*

The grid and curvilinear systems both have advantages and disadvantages. However, grid street patterns with alleys have one large drawback in the LID context: grids typically require 20 to 30 percent more total street length than curvilinear patterns (CWP, 1998; Center for Housing Innovation, 2000; CMHC, 2002). Recently, planners have integrated the two prevalent models to incorporate the strengths of both. These street networks have several names including open space, hybrid and headwater street plans (see figure 3.15).

figure 3.15

Hybrid or open space road layout.
Source: AHBL



3

3.2 New Suburban Development

The road and pedestrian pathways in the loop road design illustrate multifunctional site layout (see figure 3.16). Specifically, the loop road design:

- Minimizes impervious road coverage per dwelling unit.
- Provides adequate turning radius for fire and safety vehicles.
- Provides through-traffic flow with two points of access.
- Provides a large bioretention area in the center of the loop and a visual landscape break for homes facing the road.



figure 3.16

Loop road design improves fire and safety access and provides enhanced stormwater management with integrated bioretention.

Source: AHBL

The open space pathways between homes (green streets):

- Provide a connected pedestrian system that takes advantage of open space amenities.
- Provide additional stormwater conveyance and infiltration for infrequent, large storm events.

Together lot configuration, pedestrian accessibility and efficient vehicle access influence road layout. The following are lot layout and pedestrian design strategies to create effective transportation networks and minimize impervious surface coverage:

- Cluster homes to reduce overall development envelope and road length (Schueler, 1995).
- Narrow lot frontages to reduce overall road length per home (Schueler, 1995).
- Reduce front yard setbacks to reduce driveway length.
- For grid or modified grid layouts, lengthen street blocks to reduce the number of cross streets and overall road network per home, and provide mid-block pedestrian and bike paths to reduce distances to access transit and other services (Center for Housing Innovation [CHI], 2000).
- Where cul-de-sacs are used, provide pedestrian paths to connect the end of the street with other pathways, transit or open space (Ewing, 1996).
- Provide paths in open space areas to increase connection and access for pedestrians and bicyclists (Ewing, 1996).
- Create pedestrian routes to neighborhood destinations that are direct, safe and aesthetically pleasing (CHI, 2000).
- Reduce road widths and turn around area coverage (see road widths, parking and driveway sections below).

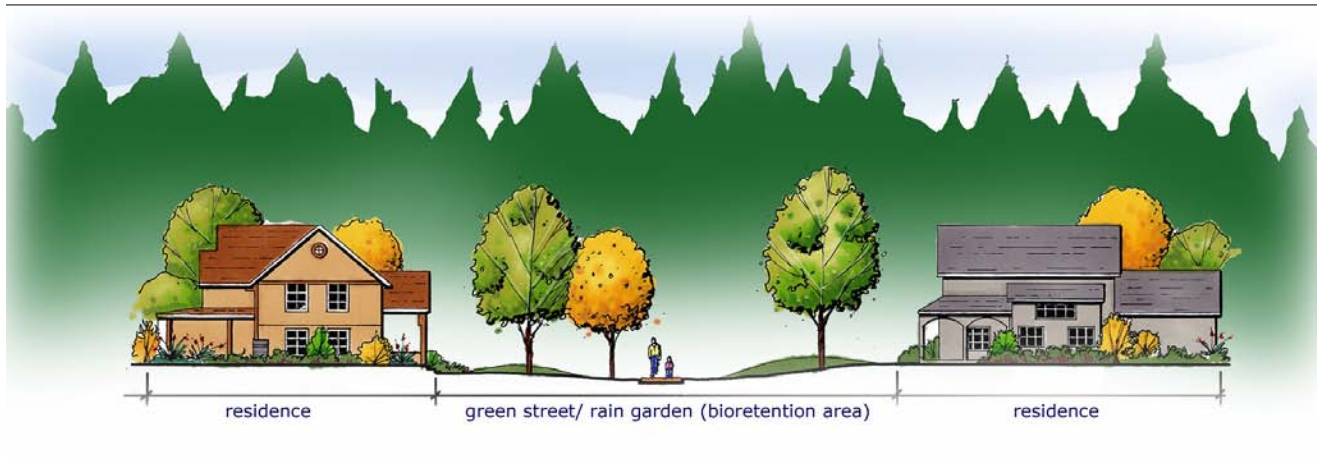

figure 3.17

Green street - provides pedestrian access, open space, and additional stormwater management areas for large storm events.

Source: AHBL

Low-density or large lot development offer increased opportunities or land area to integrate LID dispersion, storage and infiltration strategies. The greater distances between residences can, however, increase the overall road network and total impervious coverage per dwelling (Schueler, 1995). Preserving or restoring native soils and vegetation along low-density road networks and driveways, and dispersing storm flows to those areas, offers a low cost and effective LID strategy. Designs for dispersion should minimize surface flow velocities and not concentrate storm flows.

The strategies for road, driveway, parking and other LID designs appropriate in medium to high-density settings (see Section 3.1.1) can be applied in large lot settings as well.

Road Width

Residential road widths and associated impervious surface have, for various reasons, increased by over 50 percent since the mid-1900's (Schueler, 1995). Road geometry, including road widths, are derived primarily from two sources: AASHTO and ITE (Schueler, 1995). A standardized guideline for residential roads that responds to general safety, traffic flow, emergency access and parking needs is often adopted from these

sources to fit various development scenarios. For example, AASHTO recommends 26-foot pavement widths and 50-foot right of way for residential roads across various density and traffic load demands. Additionally, many communities continue to equate wider streets with better and safer streets. Studies indicate, however, that residential accidents may increase exponentially as the street gets wider and narrower roads that reduce traffic speeds are safer (CHI, 2000; NAHB et al., 2001; and Schueler, 1995).

Total and effective impervious area can be significantly reduced by determining specific traffic, parking and emergency vehicle access needs and designing for the narrowest width capable of meeting those requirements. Reducing the street width from 26 to 20 feet reduces TIA by 30 percent. In the road network represented in figure 3.15, the 30 percent reduction represents a storm flow reduction from 15,600 cubic feet to 12,000 cubic feet for a 2 inch, 24-hour storm. Examples of narrow street widths tailored to traffic need from different U.S. locations and from ULI are provided in Table 3.2. Examples of LID road sections incorporating bioretention are provided in figure 3.18.

3

3.2 New Suburban Development

table 3.2 Examples of narrow street widths from various jurisdictions.

Location or Source	Street Type	Width	Volume (ADT*)	Parking
Buck's County, PA	local access (2-way)	18 ft	200	none
Buck's County, PA	residential collector (2-way)	20 ft	200-1,000	none
Portland, OR	Queuing (2-way)	26 ft	not reported	both sides
ULI	shared driveway (5-6 homes)	16 ft	not reported	not reported
ULI	Local (2-way)	18 ft	not reported	one side only
ULI	Local (2-way)	22-26 ft	not reported	both sides
ULI	alley	12 ft	not reported	none
City of Seattle	local access (2-way)	14 ft	125 (from traffic counts)	none
City of Seattle	local access (2-way)	20 ft	250 (from traffic counts)	one side
City of Seattle	Local residential access	25 ft		both sides
City of Olympia	local access (2-way)	18 ft	0-500	none
City of Olympia	local access (2-way queuing)	18 ft	0-500	one side alternating
City of Olympia	neighborhood collector (2-way)	25 ft	500-3000	one side alternating

* ADT: Average daily traffic

figure 3.18

Examples of LID road sections.

Example of 24' wide road with bioretention on one side and utility location detail

Source: SVR

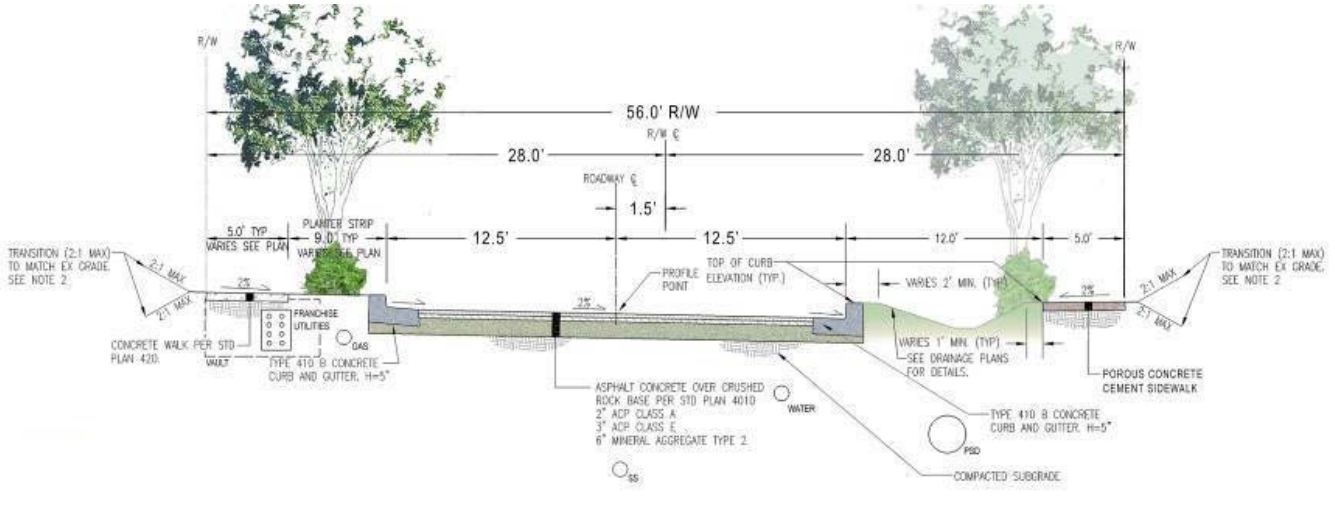

Example of 20' roadway bioretention on both sides.

Source: City of Seattle

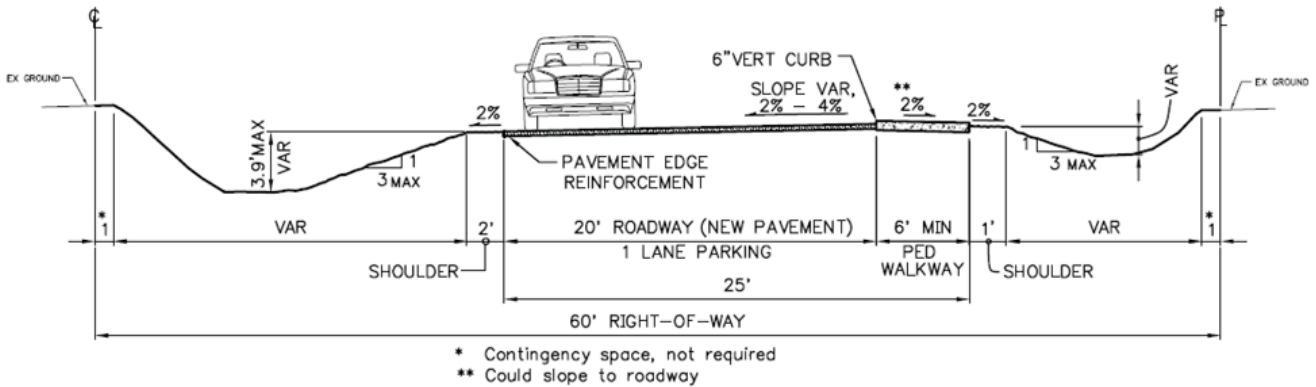

Example of 20' roadway bioretention on one side.

Source: City of Seattle

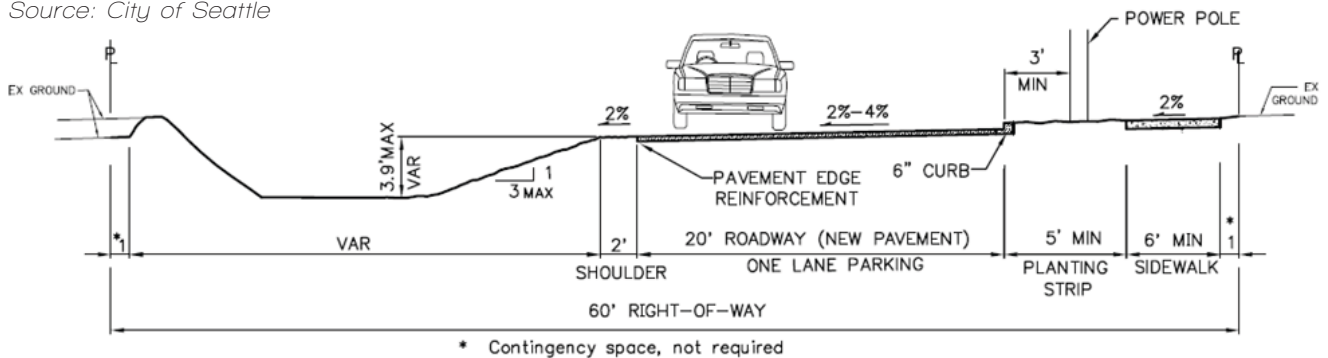

3

3.2 New Suburban Development

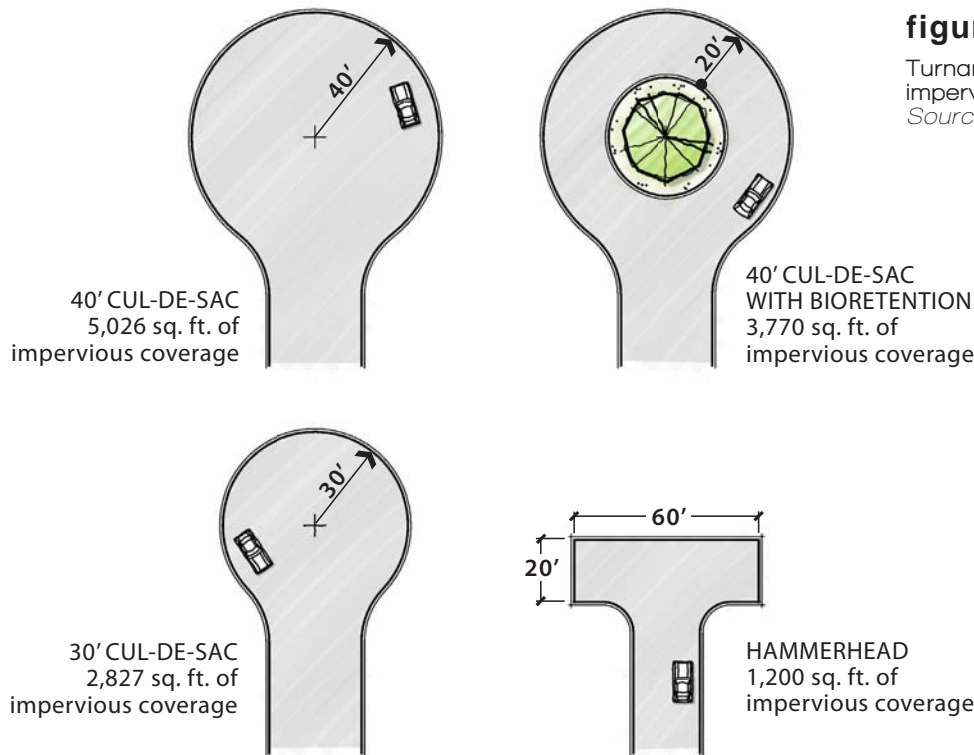

figure 3.19

Turnaround areas and associated impervious coverage.
Source: AHBL

Turnarounds

Dead end streets with excessive turn around area (particularly cul-de-sacs) can needlessly increase impervious area. In general, dead end or cul-de-sac streets should be discouraged; however, a number of alternatives are available where topography or other site specific conditions suggest this road design. Thirty-foot radius turnarounds are adequate for low volume residential roads servicing primarily passenger vehicles (AASHTO, 2001 and NAHB et al., 2001). A 40-foot radius with a landscaped center will accommodate most service and safety vehicle needs when a minimum 20-foot internal turning radius is maintained (Schueler, 1995). The turning area in a cul-de-sac can be enhanced by slightly enlarging the rear width of the radius. A hammerhead turnaround requires vehicles to make a backing maneuver, but this inconvenience can be justified for low volume residential roads servicing 10 or fewer homes (NAHB et al., 2001). A 10-foot reduction in radius can reduce impervious coverage by 44 percent and the hammerhead configuration generates approximately 76 percent less impervious

surface than the 40-foot cul-de-sac. Four turnaround options and associated impervious surface coverage are presented in figure 3.19.

Islands in cul-de-sacs should be designed as bioretention or detention facilities. The street should be graded to direct flow to the island and either a flat concrete reinforcing strip or curb-cuts can be utilized to allow water into the facility.

The loop road configuration is an alternative to the dead end street and provides multiple access points for emergency vehicles and residents (see figures 3.15 and 3.16). For similar impervious surface coverage, the loop road has the additional advantage of increasing available storm flow storage within the loop compared to the cul-de-sac design.

Parking

Many communities require 2 to 2.5 parking spaces per dwelling. Driveways and garages can accommodate this need in most cases, and providing curb side parking on both sides of the street and two travel lanes (i.e., the 36-foot wide local residential street) creates excess impervious surface. Parking needs and traffic movement can be met on narrowed roads where one or two on-street parking lanes serve as a traffic lane (queuing street) (CWP, 1998). Figure 3.20 provides two examples of queuing streets for local residential streets.

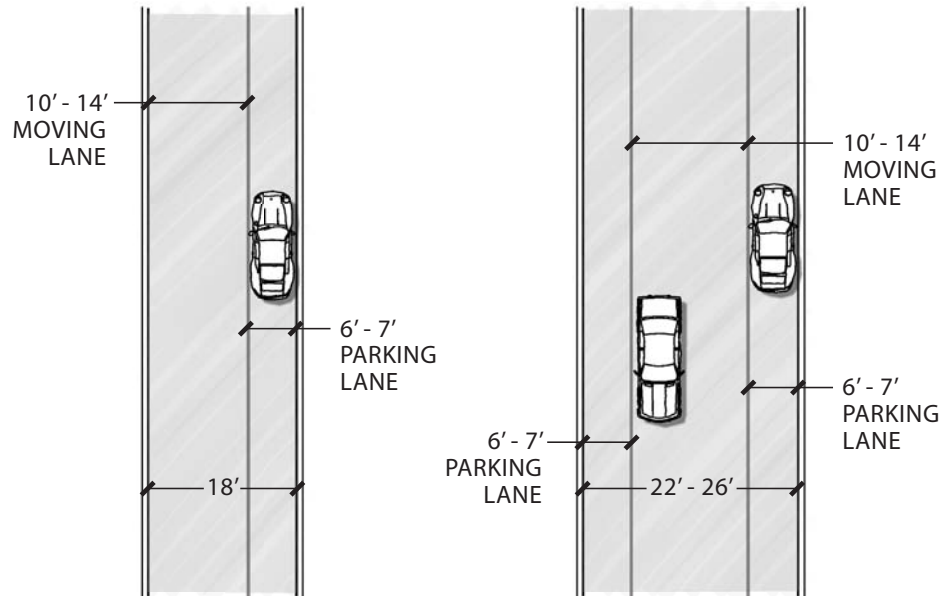

figure 3.20

Queuing street options to reduce impervious coverage.
Source: AHBL

In higher density residential neighborhoods with narrow roads and where no on-street parking is allowed, pullout parking can be utilized. Pullouts (often designed in clusters of 2-4 stalls) should be strategically distributed throughout the area to minimize walking distances to residences. Depending on the street design, the parking areas may be more easily isolated and the impervious surface rendered ineffective by slightly sloping the pavement to adjacent bioretention swales or bioretention cells (see figure 3.21).

All or part of pullout parking areas, queuing lanes or dedicated on-street parking lanes can be designed using permeable paving. Permeable asphalt, concrete, pavers and gravel pave systems can support the load requirements for residential use, reduce or eliminate storm flows from the surface, and may be more readily acceptable for use on lower-load parking areas by jurisdictions hesitant to use permeable systems in the travel way. Particular design and management strategies for subgrade preparation and sediment control must be implemented where pullout parking or queuing lanes receive storm flows from adjacent impervious areas (see Section 6.3: Permeable Paving for details).



figure 3.21

Pullout parking disturbed along the roadway replaces on-street parking for this 14-foot wide residential access road that incorporates bioretention within the right-of-way.
Source: Photo by Colleen Owen

3

3.2 New Suburban Development

Traffic Calming Strategies

Several types of traffic calming strategies are used on residential roadways to reduce vehicle speeds and increase safety. Street trees, consistently placed, are just one of many tools useful to visually confine and define the direction of travel and space available to drivers. Other traffic calming design features include neck-downs, chicanes and bulb outs. These design features also offer an opportunity for storm flow infiltration and/or slow conveyance to additional LID facilities downstream (see figures 3.22 and 3.23).

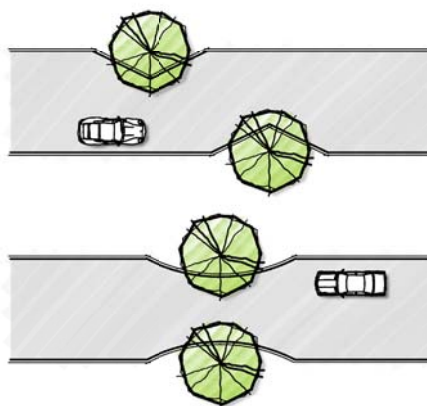

CHICANE/
STAGGERING

NARROWS/
THROTTLE

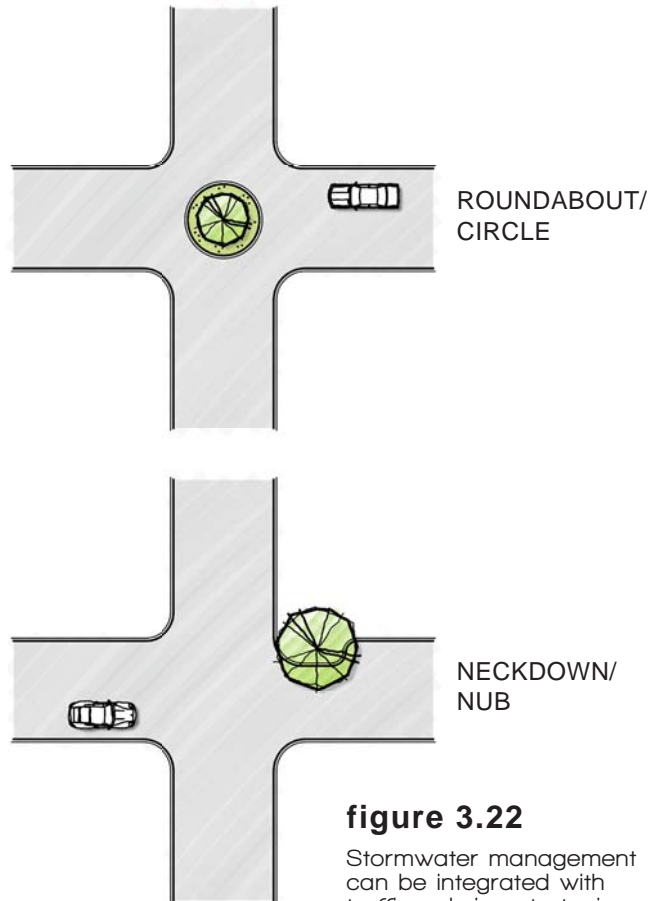

figure 3.22

Stormwater management can be integrated with traffic calming strategies.
Source: AHBL



figure 3.23

Stormwater management integrated with traffic calming strategies (Portland, OR).
Source: Photo by Curtis Hinman

Driveways

As much as 20 percent of the impervious cover in a residential subdivision can be attributed to driveways (CWP, 1998). Several techniques can be used to reduce impervious coverage associated with driveways:

- Shared driveways provide access to several homes and may not need to be as wide as local residential roads (see figure 3.24). Recommendations range from 9-16 feet in width serving 3-6 homes (NAHB et al., 2001 and Prince George's County, Maryland, 2000). A hammerhead or other configuration that generates minimal impervious surface may be necessary for turnaround and parking area.
- Minimize front yard setbacks to reduce driveway length.
- Reduce minimum driveway width from 20 (common standard) to 18 feet. Driveways can be reduced further to 10 feet with a bulb-out at the garage.
- Use permeable paving materials and aggregate storage under wearing surface.
- Limit impervious surface to two tracks with remainder in reinforced grass or other pervious surface (California strips).



figure 3.24

Shared driveway in Issaquah Highlands, WA.
Source: Photo by Curtis Hinman

- Direct surface flow from driveways to compost-amended soils, bioretention areas or other dispersion and infiltration areas (see Section 6.2: Amending Construction Site Soils and Section 6.1: Bioretention Areas for details).

Shared driveways are applicable in large lot as well as higher density settings. Figure 3.25 is a large lot conservation design for protecting open space and uses shared driveways to access homes.

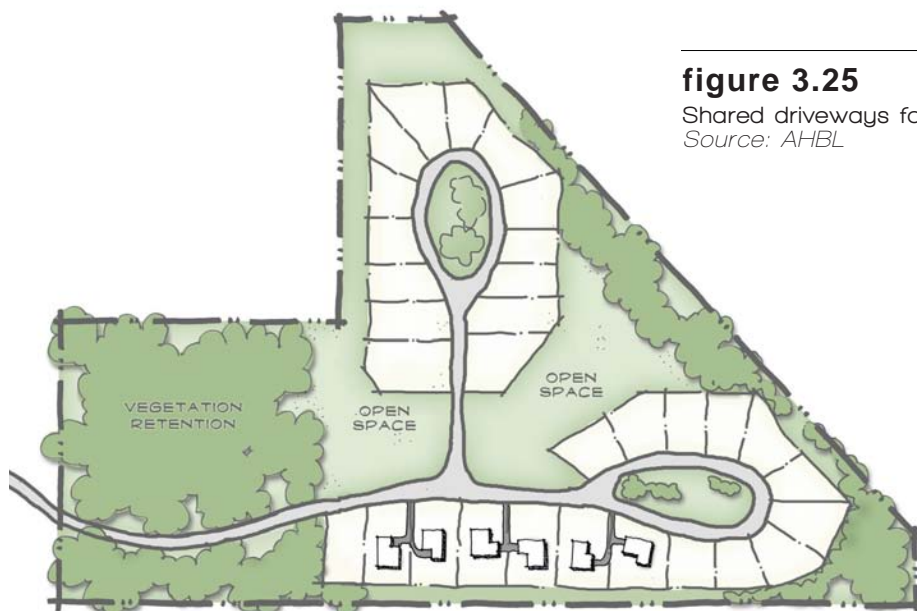

figure 3.25

Shared driveways for large lots.
Source: AHBL

Sidewalks

Many jurisdictions require sidewalks on both sides of residential roads for safety and perceived consumer demand. Studies indicate that pedestrian accident rates are similar in areas with sidewalks on one or both sides of the street (CWP, 1998). Limited assessments suggest that there is no appreciable market difference between homes with sidewalks on the same side of the street vs. homes with sidewalks on the opposite side of the road (CWP, 1998). The Americans with Disabilities Act (ADA) does not require sidewalks on both sides, but rather at least one accessible route from public streets (WAC 51-40-1100, 2003). Impervious surface coverage generated by sidewalks can be reduced or mitigated using the following strategies:

- Reduce sidewalk to a minimum of 48 inches (36 CFR Part 1190, Accessibility Guidelines for Pedestrian Facilities in the Public Right-of-Way).
- For low speed local access roads, eliminate sidewalks or provide sidewalks on one side of the road. A walking and biking lane, delineated by a paint stripe, can be included along the roadway edge.
- Design a streetscape to accommodate bioretention swales or bioretention cells along and street trees between the sidewalk and the street to provide a visual break and ensure adequate space for a varied palette of vegetation for optimum stormwater attenuation and pedestrian safety. (See figure 3.26.)
- Install sidewalks at a 2 percent slope to direct storm flow to bioretention swales or bioretention cells—do not direct sidewalk water to curb and gutter or other hardened roadside conveyance structures.
- Use permeable paving material to infiltrate or increase time of concentration of storm flows (see Section 6.3: Permeable Paving for details).



figure 3.26

SEA streets sidewalk and swale, Seattle, WA
Source: City of Seattle

3.2.2 Lot layout

Typical residential development determines lot size by dividing the total plat acreage, minus the roads and regulated sensitive areas, by the number of lots allowed under the applicable zoning. Most, if not all, of the site is cleared and graded. In contrast, LID projects employ clustering and other planning strategies to minimize site disturbance, maximize protection of native soil and vegetation, and permanently set aside the open tracts for multiple objectives including stormwater management. Four general objectives should guide the placement and orientation of lots for LID projects:

- Minimize site disturbance.
- Strategically locate lots for dispersing stormwater to open space areas.
- Orient lots and buildings to maximize opportunities for on-lot infiltration or open conveyance through bioretention swales or cells to downstream LID facilities.
- Locate lots adjacent to, or with views of, open space to improve aesthetics and privacy.

The following examines three prevalent development strategies applied in a low impact development context: Medium to high-density cluster, rural cluster, and large lot development.

Medium to high-density cluster (4 or more dwelling units per acre)

Clustering is a type of development where buildings are organized together into compact groupings that allow for portions of the development site to remain in open space (Maryland Office of Planning, 1994). In the U.S., the primary focus of cluster development has been to preserve natural and cultural features, provide recreation, preserve rural character, and produce more affordable housing (Schueler, 1995).

The LID cluster may include the above objectives; however, the primary purpose of the low impact development cluster is to minimize the development envelope, reduce impervious coverage, and maximize native soil and forest protection or restoration areas. Natural resource protection areas (the preferred strategy) are undisturbed conservation areas. Restoration areas (appropriate where land is or will be disturbed) can be enhanced through soil amendments and native planting to improve the hydrologic function of the site. Both can provide dispersion for overland

figure 3.27

Conventional vs LID lot layout.
Source: AHBL

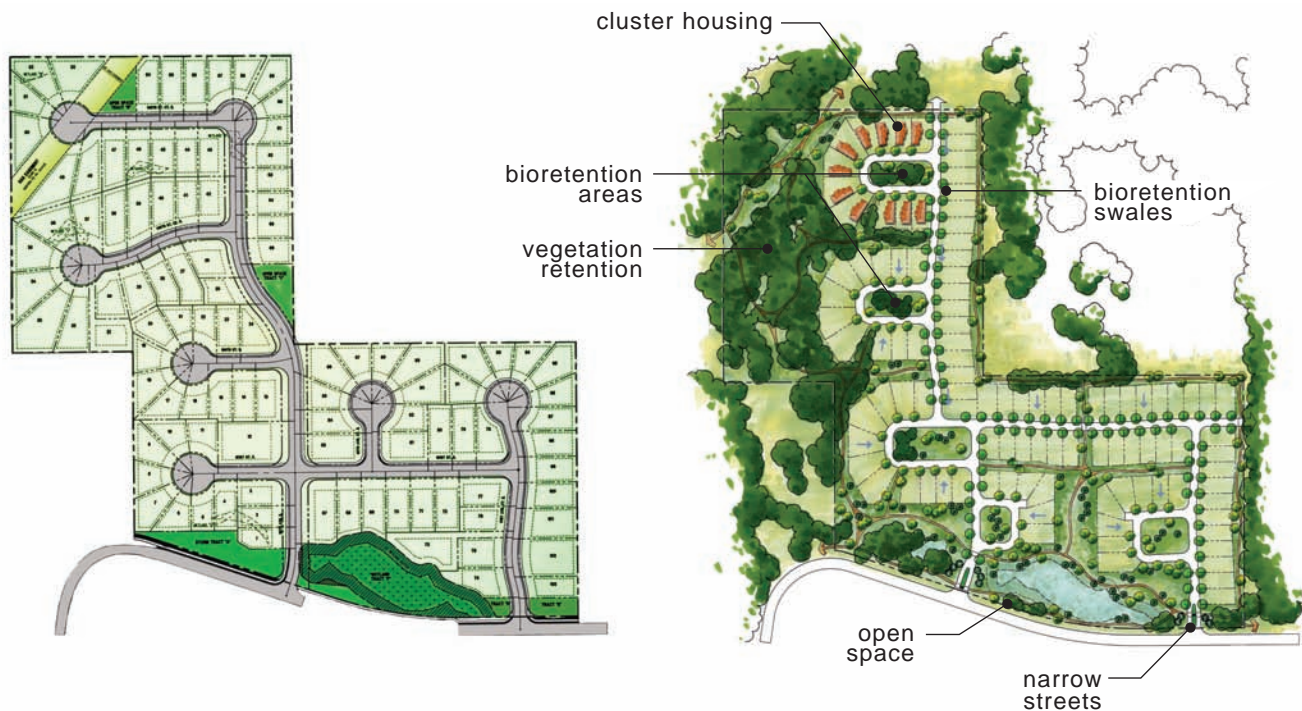

3

3.2 New Suburban Development

flows generated in developed areas. Demonstration projects indicate that significant open space protection can still be achieved over conventional development projects designed with relatively small lot sizes when using cluster strategies (see figures 3.27 and 3.29 and Fairhaven Heights case study).

Objectives for medium to high-density clustering:

- Medium-density (4 to 6 dwelling units per acre): reduce the development envelope in order to retain a minimum of 50 percent open space.
- High-density (more than 6 dwelling units per acre): protect or restore to the greatest extent possible. Note: in medium to high-density settings, reducing the development envelope and protecting native forest and soil areas will often require multifamily, cottage, condominium or mixed attached and detached single family homes.

Techniques to meet objectives for medium to high-density clustering include:

- Minimize individual lot size (3,000-4,000 square-foot lots can support a medium-sized home designed to occupy a compact building footprint).
- Minimize setbacks. Examples of minimum setbacks include:
 - » 25-foot front yard.
 - » 3-foot side yard (minimum side yard setbacks

should allow for fire protection ladder access and structures with narrow side yards should use fire resistant siding materials).

- Use zero lot line set back to increase side yard area (see figure 3.28).
- Use cottage designs for a highly compact development envelope.
- Amend disturbed soils to regain stormwater storage capacity (see Section 6.2: Amending Construction Site Soils).
- Drain rooftops to cisterns for non-potable reuse within the house or garden (see Section 6.7: Roof Rainwater Collection Systems).
- Utilize vegetated roof systems to evaporate and transpire stormwater (see Section 6.5: Vegetated Roofs).
- Lay out roads and lots to minimize grading to the greatest extent possible.
- Stormwater from lots not adjacent to forested/ open space infiltration areas can be conveyed in swales or dispersed as low velocity (< 1fps) sheet flow to the infiltration areas.
- Orient lots to use shared driveways to access houses along common lot lines.
- To maximize privacy and livability within cluster developments, locate as many lots as possible adjacent to open space, orient lots to capture



figure 3.28

Zero lot line configuration.
Source: AHBL

views of open space, and design bioretention swales and rain gardens as visual buffers.

- Set natural resource protection areas aside as a permanent tract or tracts of open space with clear management guidelines.

Good site assessment is critical where development is proximate to or may directly impact sensitive areas. Equally important is creative site design (informed by

the site assessment) that strategically protects native soil, vegetation and hydrology to the maximum extent possible. The following case study of Fairhaven Heights provides a good example of that design and assessment process with a site plan that accommodates scheduled growth and protects sensitive areas.

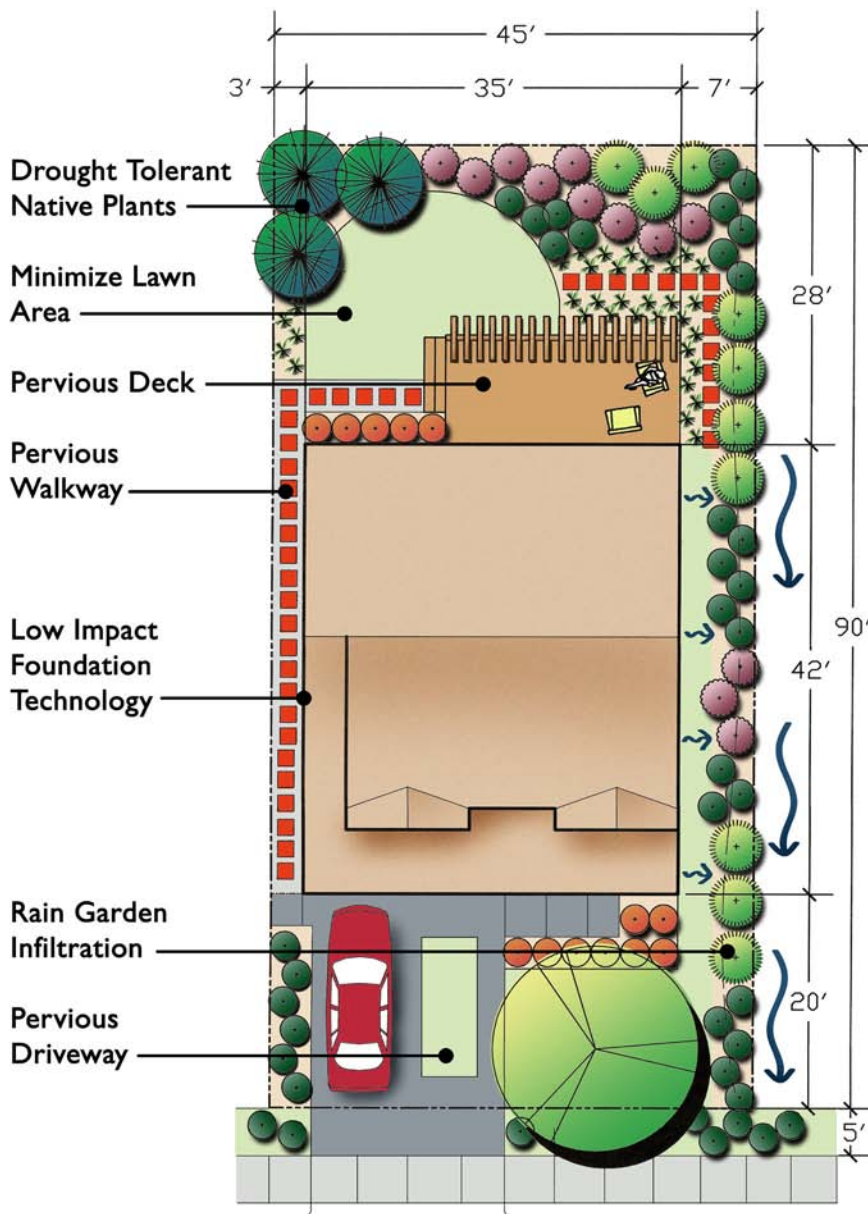

figure 3.29

Small lot layout using LID practices.

Source: AHBL

Project Case Study: Fairhaven Heights

Low impact development practices applied at Fairhaven Heights:

Site Assessment and Planning:

- Detailed site analysis characterizing soils, vegetation, hydrology, topography, as well as community context.
- Clustering.
- Diverse use of housing types to reduce the development envelope and building heights while creating an aesthetically pleasing, desirable neighborhood.
- Creative use of open space.
- Retained vegetation and soils.

Stormwater Management:

- Reduction of impervious surfaces.
- Use of amended top soil.
- Bioretention.
- Permeable pavement.

Project background

This 82-acre infill site, located in northern Puget Sound, had been logged several times and was quarried for gravel, but now contains second and third growth vegetation and wetlands. Under early planning regulations the site was slated to accommodate a significant amount of growth at over 1,460 residential units. Changes in the 1990s reduced site entitlement to 739 units, which represented 3-5 percent of the city's projected housing needs to 2022.

The site is well-situated to accept growth. It is mostly surrounded by development and is within an urban boundary. Single-family homes border the west, south and northeast sides of the site and multifamily housing is located to the north. The site is less than a half mile from two schools and an existing bus route that passes within a couple of hundred feet of its western border could be extended to the property.

The site's critical areas, however, physically restricted future development. Several wetlands bisect the site, restricting connection between the two areas for future development. Also, there are a few areas of critical slopes towards the north end of the property.

Site analysis

Topography, soils, stormwater, micro-climate, flora and fauna are all an interconnected part of an ecosystem. The site analysis focused on gaining a thorough understanding of ecosystem functions and how proposed development would be compatible with those functions.

Understanding site hydrology was critical for protecting the site's wetlands. Water quantity, quality and temperature contributed to the health of on-site habitat and offsite systems. Site studies, including nearly 50 pits and borings, probed into soils, water infiltration rates and fluctuations through the seasons and examined how the wetlands might be interconnected both above and below grade. The site drains to two major watersheds, but contains many small watersheds, each requiring detailed analysis and measurement. The development team's goal was to maintain existing wetland hydrology post-development.

The interdisciplinary team of experts synthesized this information into analysis diagrams and a series of overlays that would guide site planning. Based on this information an approximate development boundary was established that would encompass the flattest site areas and the former gravel quarry; avoid critical slopes, significant wetlands and their required buffers; and maintain large stands of vegetation. Several smaller isolated lower quality wetlands that were created through the site quarrying could be filled within regulations. Mitigation for these smaller wetlands would include enhancement and restoration of damaged areas within the higher quality wetlands and their buffers. Further, wetland buffers would be enhanced beyond minimum requirements, where necessary, to maintain their functions.

Site planning and layout

In order to minimize the impact of the development, the smallest, most compact site development footprint was achieved through creative site planning. Proposed uses are limited to about half the site, leaving 40 acres as preserved natural area and enhanced wetland

figure 3.30

Fairhaven Heights Site Plan.

Source: Weber+Thompson



3

3.2 New Suburban Development

April 2005 Plan

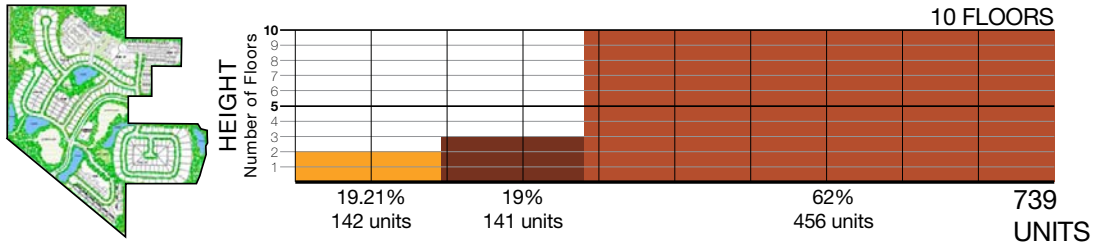

2008 Enhanced Buffer Plan

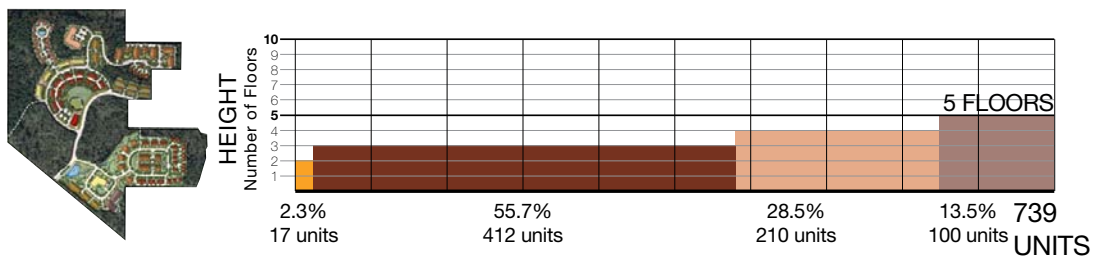

Comparison of BUILDING HEIGHT

April 2005 Plan

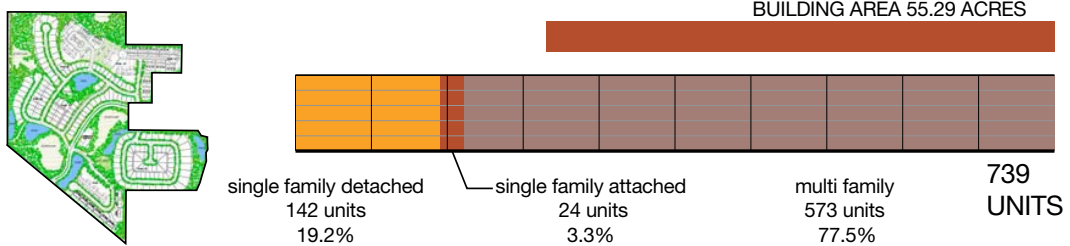

2008 Enhanced Buffer Plan

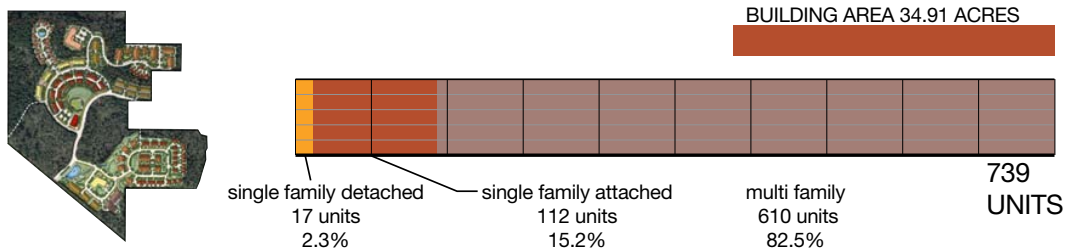

Comparison of HOUSING MIX

April 2005 Plan

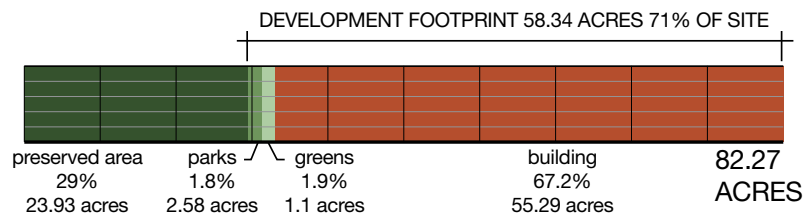

2008 Enhanced Buffer Plan

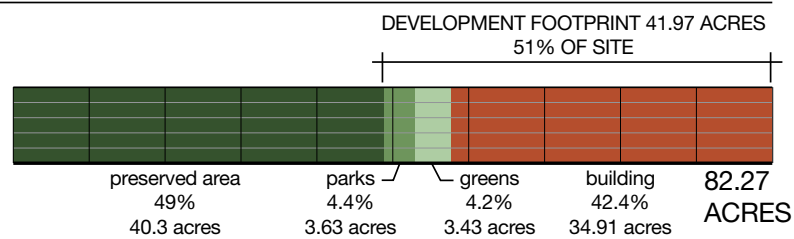

Comparison of OPEN SPACE VS. BUILDING AREA

Fairhaven Heights - Comparison of Building Height, Housing Mix, and Open Space vs. Building Area.
Source: Weber+Thompson

figure 3.31

buffers. This was accomplished through a marriage of modest tweaks to the building program and building type, efficient land planning that worked in conjunction with the site's features and topography, and low impact development strategies, all of which maintained the allowed 739 residential units.

In previous site plan proposals, single-family detached homes were less than 20 percent of the building program but occupied nearly two-thirds of the proposed land area. There were a small amount of town homes and the majority (537 units) were placed in multifamily buildings with nearly two-thirds of the residences in 8-10 story buildings. By adding more town homes to the program and reducing the amount of single-family detached homes, the design was able to save an additional 20 acres of land area from development. At the same time, by proposing more low-rise multifamily structures with grade related entrances, the development would have the feel and scale of town homes, provide more variety of unit types

to the multifamily housing program, and likely attract a wider range of residents.

In order to meet 739 units, one might suspect that building height had to increase as a result of reducing the land area; in fact, the converse is true. The plan allowed more area for multifamily structures and, in turn, the overall height of buildings could be reduced. More than half the proposed site's homes are in 2-3 story structures and only 100 units (or 13 percent) are in one five-floor structure; accordingly, little or none of the development would be visible beyond the preserved trees. As the previous plan had 62 percent of its units in 8-10 story buildings, the visibility of the project to the surrounding neighbors was a concern.

Another land saving tactic was in the handling of parking. Nearly all structures used the topography to have tuck-under parking, thereby freeing up more land for other purposes. While this is a more expensive way of handling parking, savings were achieved in other

3

3.2 New Suburban Development

ways. Fewer roads and less infrastructure and re-grading would reduce site development construction costs, while reduced building height allowed for a less expensive construction type.

The compact design had compounding environmental benefits as well. Reducing the development envelope reduced the amount of land disturbed for construction and allowed very large contiguous swaths of vegetation, soils and habitat to be preserved as well as the amount of roads, parking and associated storm water runoff. At the same time, the plan provides a generous amount of planned green spaces, centrally located parks and community centers, and access to trails, transit and natural areas that together provide exceptional livability in a compact, pedestrian and socially focused community.

Site topography informed location of roads and shape of each neighborhood. In order to avoid extensive re-grading, the proposed roads follow existing topography, working their way gradually up and around hills. The site's entrance road posed a particular challenge. Wetlands and topography, combined with design restrictions on the main access road, resulted in one feasible access point and would require skirting between the site's two major wetlands to connect the development. To allow water and wildlife to flow underneath, the proposed road would be raised over the wetland at key locations. To combat this lack of vehicle inner-connectivity between the two sides, many trail connections are planned that would make it easy to walk within the neighborhood and connect to a future transit link on the main road.

In conjunction with the civil engineer, wetland biologist and landscape architects, the site plan employs low impact storm water strategies that are modeled to maintain pre-development hydrology. Proposed linear rain gardens or bioretention swales line every street.

Permeable pavement in alleys and on parking strips infiltrates stormwater where it falls. Runoff is also directed to a series of rain gardens in neighborhood green spaces, including a large infiltration area over the former gravel pit, now turned central park. All these features serve to slow, clean, cool and infiltrate the runoff before it is dispersed to the wetlands. At the low point of the site near the entrance, some runoff is held back from an overflow vault for a water feature. There is only one small conventional stormwater pond located near the single-family homes.

Planning and Architecture: Weber Thompson
Civil Engineer: Ronald T. Jepson and Associates
Geotech, Hydrology: GeoEngineers, Inc.
Landscape Architect: The Watershed Company
Traffic: The Transpo Group

Air Space Condominiums

A little known, but effective, cluster strategy is Air Space Condominium design. In this design scenario (applicable for most single-family residential development), the property is not divided into separate lots. Instead, designated areas, or air space, that include the dwelling and some additional yard space (optional) are available for purchase, with the remaining property held in common and managed by a homeowners association. Stormwater management practices are held within an easement for local jurisdiction access and require a long-term management agreement followed by the homeowners. The advantage of the condominium classification is increased design flexibility including:

- The entire road network can be considered as driveway, reducing design standards for road widths, curb and gutter, etc.
- No minimum lot size.
- Reduced overall development envelope.
- Note: fire and vehicle safety requirements must still be satisfied.

Rural Cluster and Large Lot Development

Impervious surfaces can be substantially reduced through clustering large lot development. In a study comparing 100-lot subdivision designs, the Maryland Office of State Planning found a 30 percent reduction in impervious surface when lot size was reduced from a typical rural density of 1.4 to 0.25 acres. Additional road network and driveway lengths are the primary reasons for increased imperviousness associated with large lot development (Delaware Department of Natural Resources and Environmental Control and the Environmental Management Center of the Brandywine Conservancy, 1997). Increased storm flows from the additional road network required to serve rural cluster and large lot designs should be dispersed to bioretention swales, adjacent open space and/or lawn areas amended with compost (see figure 3.32).

Objectives for rural clustering and large lots:

- Reduce the development envelope in order to retain a minimum of 65 percent of the site in native soil and vegetation.
- Reduce EIA to zero (i.e., fully disperse stormwater).



figure 3.32

Conventional large lot vs. rural cluster.
Source: AHBL

Medium to high-density cluster guidelines can be used in large lot settings. The increased land area in the rural cluster and large lot scenarios offer additional opportunities including:

- Integrate bioretention and open bioretention swale systems into the landscaping to store, infiltrate, slowly convey, and/or disperse stormwater on the lot.
- Disperse road and driveway stormwater to adjacent open space and lawn areas (see Chapter 7: Flow Modeling Guidance for dispersion details).
- Maintain pre-development flow path lengths in natural drainage patterns.
- Preserve or enhance native vegetation and soil to disperse, store and infiltrate stormwater.
- Disperse roof water across the yard and to open space areas or infiltrate roof water in infiltration trenches.
- Lots may be organized into cluster units separated by open space buffers as long as road networks and driveways are not increased significantly and the open space tract is not fragmented.
- Place clusters on the site and use native vegetation to screen or buffer higher density clusters from adjacent rural land uses.

3.2.3 Building Design

Impervious surface associated with roofs ranges from approximately 15 percent for single-family residential, 17 percent for multifamily residential, and 26 percent for commercial development (City of Olympia, 1995). As densities increase for detached single-family residential development, opportunities for infiltrating roof stormwater decrease; however, other strategies to process this water can be applied.

The objectives for building design are to disconnect roof stormwater from stormwater conveyance and pond systems (i.e., eliminate roofs as effective impervious surface) and reduce site disturbance from the building footprint. Strategies to minimize storm flows and disturbance include:

- Reduce building footprint. Designing taller structures can reduce building footprints and associated impervious surface by one-half or more in comparison to a single story configuration. Proposals to construct taller buildings can also present specific fire, safety and health issues that may need to be addressed. For example, any residence over two stories requires a fire escape and a sprinkler system. These additional costs may be partially reduced by a reduction in stormwater conveyance and pond systems and stormwater utility fees.
- Orient the long axis of the building along topographic contours to reduce cutting and filling.
- Control roof water onsite (see Section 6.5: Vegetated Roofs and Section 6.7: Roof Rainwater Collection Systems for design guidelines).
- Use low impact foundations (see Section 6.6: Minimal Excavation Foundations).
- Limit clearing and grading to road, utility, building pad, landscape areas and the minimum amount of extra land necessary to maneuver machinery. All other land should be delineated and protected from compaction with construction fencing (see Chapter 4: Vegetation and Soil Protection and Reforestation, and Chapter 5: Precision Site Preparation and Construction).

3.3 Commercial Development

3.3.1 Parking

Parking lots and roof tops are the largest contributors to impervious surface coverage in commercial areas. Typical parking stall dimensions are approximately 9-9.5 feet by 18.5-19 feet, totaling 166.5 and 180.5 square feet, respectively (Schueler, 1995 and City of Olympia, 1995). Considering the total space associated with each stall, including overhangs, access isle, curbs, and median islands, a parking lot can require up to 400 square feet per vehicle or approximately one acre per 100 cars (CHI, 2000). The large effective impervious coverage associated with parking areas accumulates high pollutant loads from atmospheric deposition and vehicle use (auto pollutant contributions can be particularly heavy during stopping and starting a vehicle). As a result, commercial parking lots can produce greater levels of petroleum hydrocarbons and trace metals (cadmium, copper, zinc, lead) than many other urban land uses (Schueler, 1995 and Bannerman et al., 1993).

Many jurisdictions specify parking demand ratios as a minimum number of spaces that must be provided for the development type, number of employees, gross floor area or other parking need indicator. While parking infrastructure is a significant expense for commercial development, providing excess parking is often perceived as necessary to attract (or not discourage) customers. As a result, minimum standards are often exceeded in various regions of the U.S. by 30 to 50 percent (Schueler, 1995).

“In a local study, the city of Olympia found that 70 percent of all parking lots surveyed had at least 25 percent additional capacity during normal and peak hours (City of Olympia, 1995). The same study concluded that a 20 percent reduction in parking stalls was feasible without significantly impacting business activity.”

Capping parking demand ratios to reflect actual need is the most effective of several methods used to reduce impervious coverage in parking areas. In a commercial parking area selected in the Olympia study (526 stalls), a 20 percent reduction (105 stalls) would reduce surface flows by approximately 4,000 cubic feet for a typical two-year event (City of Olympia, 1995).

To reduce impervious coverage, storm flows and pollutant loads from commercial parking areas, several LID strategies can be employed:

- Assess parking demand ratios to determine if ratios are within national or, if available, actual local ranges (Schueler, 1995).
- Establish minimum and maximum or median parking demand ratios and allow additional spaces above the maximum ratio only if parking studies indicate a need for added capacity.
- Dedicate 20 to 30 percent of parking to compact spaces (typically 7.5 by 15 feet).
- Use a diagonal parking stall configuration with a single lane between stalls (reduces width of parking isle from 24 to 18 feet and overall lot coverage by 5 to 10 percent) (Schueler, 1995).
- Where density and land value warrant or where reducing TIA below a maximum allowed is required by land use plans, construct underground, under building or multi-story parking structures.
- Use permeable paving materials for the entire parking area or, at a minimum, for spillover parking that is used primarily for peak demand periods.
- Integrate bioretention into parking lot islands or planter strips distributed throughout the parking area to infiltrate, store and/or slowly convey storm flows to additional facilities.
- Encourage cooperative parking agreements to coordinate use of adjacent or nearby parking areas that serve land uses with non-competing hours of operation—for example a cooperative agreement between a church and an office or retail store (City of Olympia, 1995).

3

3.3 Commercial Development

Project Case Study: Wilson Motors, Bellingham, WA

Project background

Wilson Motors has been a locally owned Bellingham business for almost three decades. Over the years they outgrew their old facility and in their search for a new location found a 6.26-acre parcel on the northern bank of Whatcom Creek. The site was the location of an auto recycling yard that had been in operation for decades.

When the development process and remediation of the brownfield site began, talks with the City of Bellingham and the design team focused on the potential impacts to Whatcom Creek, which is on Ecology's 303(d) list of Impaired Waters of the State. Because of this, stormwater quality was critical, along with stormwater quantity. During the shoreline permitting process, stormwater characteristics, including temperature, pH, water quantity, and water quality were the primary concern for the development.

To address these concerns, pervious concrete was chosen as a pavement surface for more than two acres of the site. Pervious concrete provides several pollutant removal mechanisms inherent to the paving structure. These mechanisms include: stormwater volume reduction (through infiltration), reduced spray and vehicle wash off, biological degradation, filtration, adsorption, and volatilization. The high solar reflectance index of Portland cement concrete significantly decreases the heat island effect that is normally produced by darker, less reflective surfaces. This benefit was also favorable to help provide for cooler water temperatures in the salmon habitat of Whatcom Creek.



figure 3.33

Wilson Motors.
Source: 2020 Engineering

**figure 3.34**

Wilson Motors - bioretention and pervious concrete.
Source: 2020 Engineering



Site design

During the design process, several alternatives were considered. Conventional stormwater design practices (impervious asphalt cement, catch basins, conveyance pipes, cartridge filters, vaults, etc.) were considered, and estimated to be \$465,000 in excess of the design incorporating pervious concrete. The significant cost savings, combined with its long-term lifecycle value, made pervious concrete pavement an easy choice for the owner.

The specifications for the project stated that the installer must be certified through the National Ready Mixed Concrete Association's (NRMCA) Pervious Concrete Contractor Certification Program, which ensured that the installer was experienced and knowledgeable in the field. During the pour, additional concrete workers participated to gain experience working with pervious concrete.

The LID site design also included approximately two acres of porous asphalt in the low traffic areas. Pervious concrete was selected for the high traffic and truck lane areas because of its durability and structural

integrity. Parking areas were constructed with a 6-inch thick section and the truck (heavy use) travel lane was completed with an 8-inch thick section of pervious concrete. The pervious concrete mix used within the truck lane also included an epoxy additive and fiber to increase strength and lifespan of the pavement. Stormwater detention is provided in the 40 percent void space within the aggregate base.

The result

The project's completion in September of 2008, with its demonstrated economic and environmental benefits, has caught the attention of municipalities, engineers, state officials and others interested in the implementation of LID. Because of the on-site stormwater management achieved through use of pervious concrete, the owner is eligible for additional cost savings with a 20 percent reduction in monthly stormwater fees.

Civil Engineer: 2020 Engineering

3.4 Road Crossings

Numerous studies have correlated increased total impervious area with declining stream and wetland conditions (Azous and Horner, 2001; Booth et al., 2002; May et al., 1997). Recent research in the Puget Sound region suggests that the number of stream crossings per stream length may be a relatively stronger indicator of stream health (expressed through Benthic Index of Biotic Integrity) than TIA (Avolio, 2003). In general, crossings place significant stress on stream ecological health by concentrating and directing storm flows and contaminants to receiving waters through associated outfall pipes, fragmenting riparian buffers, altering hydraulics, and disrupting in-channel processes, such as meander migration and wood recruitment (Avolio, 2003 and May, 1997). Culvert and bridge design that place supporting structures in the floodplain or active channel confine stream flows. The confined flow often increases bank and bed erosion resulting in channel enlargement downstream of the structure (Avolio, 2003). Bank armoring associated with crossings further disrupts hydraulics and channel processes and can increase the impacts of all crossing types, including less damaging bridge designs (Avolio, 2003). Improperly designed crossings using culverts can also inhibit or completely block fish passage. Design considerations for minimizing road crossing impacts include:

- Eliminate, or reduce to an absolute minimum, all stream crossings.
 - Where stream crossings are unavoidable, bridges are preferable to culverts.
 - Locate bridge piers or abutments outside the active channel or channel migration zone.
 - If culverts are utilized, install slab, arch or box type culverts, preferably using bottomless designs that more closely mimic stream bottom habitat.
 - Utilize the widest possible culvert design to reduce channel confinement.
- Minimize stream bank armoring and establish native riparian vegetation and large woody debris to enhance bank stability and diffuse increased stream power created by road crossing structures. Consult a qualified fluvial geomorphologist and/or hydrologist for recommendations.
 - All crossings should be designed to pass the 100-year flood event.
 - Cross at approximately 90 degrees to the channel to minimize disturbance.
 - Do not discharge storm flows directly from impervious surfaces associated with road crossing directly to the stream—disperse and infiltrate stormwater or detain and treat flows.

Vegetation & Soil Protection & Reforestation

4 CHAPTER

Native Vegetation and Soil Protection	4.1
Re-establishing Native Vegetation	4.2
Maintenance of Protected Areas	4.3

Mature native vegetation and soil are necessary to maintain watershed hydrology, stable stream channels, wetland **hydro-periods**, and healthy aquatic systems (Booth et al., 2002). While necessary to maintain aquatic systems, native vegetation and soils are also the most cost-effective and efficient tools for managing stormwater quantity and quality. Hydrologic modeling comparing conventional development and LID designs suggests that, of the various LID applications, reducing the development envelope and increasing vegetation and soil conservation areas are the most effective techniques to reduce storm flows (see Table 4.1) (AHBL, 2002).

“While necessary to maintain aquatic systems, native vegetation and soils are also the most cost-effective and efficient tools for managing stormwater quantity and quality.”

4 Introduction

table 4.1 Hydrologic modeling comparing a conventional development and the flow reduction benefits from individual practices for an LID design. The 24-acre till-mantled site in southern Puget Sound has 103 lots and was modeled with Western Washington Hydrologic Model.

	Detention storage reduced (ft ³)	Detention storage required (ft ³)
Conventional development	0	270,070
Low impact development design:		
Reduce development envelope (24' wide road)	-149,019	
And use bioretention swales and cells	-40,061	
And use minimal excavation foundations	-7,432	
And use 20' pervious pavement road	-29,988	
Total reduction	-226,500	43,570

Retaining **native soil and vegetation protection areas** is a primary objective for low impact development in order to: reduce total impervious surface coverage; provide infiltration areas for overland flows generated in adjacent developed portions of the project; and maintain or more closely mimic the natural hydrologic function of the site. The protection areas provide additional benefits including critical area and habitat protection, open space corridors for passive recreation, visual buffers, and erosion and sediment control.

Objectives for on-site native vegetation coverage:

- Rural and large lot development: 65 percent minimum
- Medium density (4-6 dwelling units per acre): 50 percent minimum
- High density (more than 6 dwelling units per acre): Protect or restore to the greatest extent practical. Note: In medium to high density settings, reducing the development envelope and protecting native forest and soil areas will often require multifamily, condominium, cottage or mixed attached and detached single family homes (see Chapter 3: Site Planning and Layout).

Riparian Management Areas can be included as part of the native vegetation retention area and are the highest priority for native vegetation retention and protection. The 65 percent forest retention objective is a watershed level target based on best available science for maintaining watershed hydrologic functions (Booth et. al., 2002). Not all projects can achieve 65 percent protection at the project site. However, projects attaining 40, 50 or 60 percent native vegetation protection and using a full complement of LID practices still play a critical role in achieving overall watershed protection objectives when part of a larger planning process that strategically conserves riparian and other sensitive resources at a regional scale.

The following sections provide guidelines for native vegetation protection during the construction phase, enhancement or rehabilitation of impacted areas, and strategies for long-term maintenance.

4.1 Native Vegetation and Soil Protection

Native vegetation and soil protection areas in urban, suburban, and rural settings are fragments of pre-European contact forests and prairie. Natural successional forces have been altered and active management is required to compensate for the loss of natural processes and the addition of new stressors (Matheny and Clark, 1998). Vegetation protection areas not directly adjacent to structures (or located where they may potentially impact a structure) should be managed to encourage natural successional patterns and develop diverse multilayer canopy structure, snags, large woody debris, understory vegetation, and forest duff. The protection, reforestation, and management strategies provided below are designed to maintain vegetation cover and adequate soil building and plant regeneration processes necessary for retaining these areas for the long-term.

Assessment of natural resources and the site planning process will identify and delineate critical areas and native vegetation offering the best suite of benefits, including the greatest precipitation interception and infiltration potential. The final delineation and details of the management program for the vegetation protection areas requires assessment by a qualified urban forester or landscape architect that considers size of the area, type of soil, exposure, vegetation type and structure, invasive species impacts, human use, condition of existing vegetation, and existing and post development hydrologic patterns in the area.

Selection of dispersed individual trees and tracks of native vegetation may be necessary to meet native forest and soil protection objectives. Individual trees selected for protection should have developed as individuals with well-tapered trunks and good live crown ratios (total tree height in relation to the height of the live crown). Trees from dense stands with tall, poorly tapered trunks and high irregular-shaped crowns generally do not adapt to wind and sun exposure and are not good candidates to preserve as single trees (Matheny and Clark, 1998). As a general guideline, conifers with live crown ratios of less than 30 percent tend to break in winds while trees with ratios greater than 50 percent tend to be more stable (Matheny and Clark, 1998).



These native trees, retained during clearing, have low live-crown ratios and likely will not survive in the more exposed condition.
Source: Curtis Hinman

figure 4.1

4 4.1 Objectives for on-site native vegetation coverage

Trees and other native vegetation that developed in forests or woodlands are best retained in groups of sufficient size to maintain adequate growing conditions to support the integrity of the unit. Growing conditions include slope, aspect, soil structure and moisture, sun exposure, humidity, wind, co-dependence on or competition among adjacent plants as well as other microclimatic factors. Retaining small fragments of mature, single species trees adapted to the interior of a forest stand is seldom successful (Matheny and Clark, 1998). Dramatic changes in growing conditions along newly exposed edges of larger preserved vegetation tracts can affect unit integrity and result in high initial plant mortality on the perimeter. Replacement of unhealthy trees and other vegetation with material adapted to edge environments as well as invasive species control may be necessary (Matheny and Clark, 1998).

Delineation and management of larger tracts and smaller scale, dispersed protection areas are necessary to meet retention objectives on most sites. Larger contiguous tracts are more likely to sustain healthy soils, retain diverse and dense vegetation coverage, and have less area affected by edge stress factors (increased sunlight, wind, and invasive species). Small-scale dispersed facilities can be located to intercept storm flows at the source, reduce flow volumes within small contributing areas and maintain time of concentration. Specific site and design requirements will influence the type and distribution of protection areas; however, the location and type of area can influence the extent of benefit and long-term viability. The following is a list of native vegetation and soil protection areas prioritized by location and type of area:

1. Large tracts of riparian areas that connect and create contiguous riparian protection areas.
2. Large tracts of critical and wildlife habitat areas that connect and create contiguous protection areas.
3. Tracts that create common open space areas among and/or within developed sites.
4. Protection areas on individual lots that connect to areas on adjacent lots or common protection areas.
5. Protection areas on individual lots.

4.1.1 Vegetation and Soil Protection During Construction Phase

Soil compaction is a leading cause of death or decline of mature trees in developed areas (World Forestry Center and Morgan, 1989). Most tree roots are located within 3 feet of the ground surface and the majority of the fine roots active in water and nutrient absorption are within 18 inches. Root systems can extend 2-3 times beyond the diameter of the crown (World Forestry Center and Morgan, 1993 and Matheny and Clark, 1998). Equipment activity on construction sites can severely compact soil, essentially eliminating soil pore structure at 6-8 inches below the ground surface. Compaction can extend as deep as 3 feet depending on soil type, soil moisture, and total axle load of the equipment. Foot traffic can exert per unit area pressure similar to that of a vehicle and significantly compact soil as well (Corish, 1995 and World Forestry Center and Morgan, 1989). Soil compaction results in a reduction of soil oxygen and the increase in **soil bulk density**. In response to soil compaction, tree root penetration declines, root respiration and associated uptake of nutrients and minerals decline, **mycorrhizal** activity is reduced, and susceptibility to root disease increases (Matheny and Clark, 1998).

“Soil compaction is a leading cause of death or decline of mature trees in developed areas.”

Several other direct and indirect impacts can influence vegetation health during land development, including:

- Direct loss of roots from trenching, foundation construction, and other grade changes.
- Application of fill material that can compact soil, reduce oxygen levels in the existing soil profile, and change soil chemistry.
- Damage to trunks or branches from construction equipment and activities.
- Exposure of forest interior areas to new stresses of forest edges as land is cleared.
- Changes in surface and subsurface water flow patterns.



figure 4.2 Protecting healthy trees (particularly large healthy trees) often requires strong barriers, signage and economic incentives or penalties for protection
Source: Curtis Hinman

Detrimental impacts to native vegetation and soil protection areas can be minimized through the following strategies:

- Develop a soil management plan showing areas to be protected and restoration methods for disturbed areas before land clearing starts (see “Developing a soil management plan” in Section 6.2: Amending Construction Site Soils).
- Map native soil and vegetation protection areas on all plans and delineate these areas on the site with appropriate fencing to protect soils and vegetation from construction damage. Fencing for forest protection areas should be located at a minimum of three feet beyond the existing tree canopy along the outer edge of the tree stand. Fencing should provide a strong physical and visual barrier of high strength plastic or metal and be a minimum of 3-4 feet high (see Ecology 2012 SMMWW BMP C103). Silt fencing, a compost berm or compost sock is necessary in addition to, or incorporated with, the barrier for erosion control.
- Install signs to identify and explain the use and management of the natural resource protection areas (see figure 4.3).
- Meet and walk property with equipment operators to clarify construction boundaries and limits of disturbance.
- Protect channel or drainage swales that provide a hydrologic connection to vegetation protection area(s) throughout the construction phase by fencing and erosion control measures to prevent untreated construction site runoff from entering the channel.
- Protect trees and tree root systems utilizing the following methods:
 - » Minimize soil compaction by protecting critical tree root zones. The network of shallow tree roots, active in nutrient and water uptake, extends beyond the tree canopy dripline. Assessing the extent of the root zone to protect can be factored in several ways. The dripline method may be applicable for broad-

4 4.1 Objectives for on-site native vegetation coverage

canopy trees; however, this method will likely underestimate the extent of roots and lead to extensive root damage for narrow-canopied trees and leaning trees with canopies extending to one side more than another.

- As a general guideline, the trunk diameter method provides more design flexibility for variable growth patterns. This method provides a protection area with a 1-foot radius for every 1 inch of trunk diameter at breast height (DBH ~ 4.5 ft). Factors that influence the specific distance calculated include the tree's tolerance to disturbance, age and vigor (Matheny and Clark, 1998). See figure 4.3.
- » Limit to an absolute minimum ground disturbance (excavation or fill) within the designated root protection zone. Tree species and soils will influence the ability of a tree to withstand disturbance. Consult an urban forester or landscape architect for a site specific tree protection plan with prescribed measures to minimize the impact of disturbance that cannot be avoided within the critical root zone.
 - » Prohibit all construction access to and activities (including stockpiling or disposal of construction material) in vegetation and soil protection areas with the exception of access for reforestation and/or construction of facilities designed to ensure low impact and compatibility with preservation (including but not limited to installation of pathways and/or access facilities for maintenance and /or reforestation activities).
 - » Avoid excavation or changing the grade near trees that have been designated for protection. If the grade level around a tree is to be raised, a retaining wall (preferably with a discontinuous foundation to minimize excavation) should be constructed around the tree. The diameter of the wall should be at least equal to the diameter of the tree canopy plus 5-feet. If fill is not structural, compact soil to a minimum (usually 85 percent proctor) (World Forestry Center and Morgan, 1993). Some trees can tolerate limited fill if proper soils and application methods are used. Subsoil irrigation may be required. Consult a certified arborist for recommendations.
- » Tree root systems tend to tangle and fuse among adjacent trees. Trees or woody vegetation that will be removed and that are next to preserved trees should be cut rather than pushed over with equipment (World Forestry Center and Morgan, 1993). Stumps can be ground if necessary.
 - » Restrict trenching in critical tree root zone areas. Consider boring under or digging a shallow trench through the roots with an air spade if trenching is unavoidable.
 - » Protect tree trunks and above-ground root flare with solid barriers such as plywood boxes and tree limbs during the construction phase.
 - » Prohibit the installation of impervious surfaces in critical root zone areas. Where road or sidewalk surfaces are needed under a tree canopy, non-mortared porous pavers or flagstone (rather than concrete or asphalt) or bridging techniques should be used.
 - » Prepare tree conservation areas to better withstand the stresses of the construction phase by watering, fertilizing, pruning, and mulching around them well in advance of construction activities.
- Where construction operations unavoidably require temporary access over tree root zones or other soil protection areas, provide protection as follows:
 - » For foot access or *similar light surface impacts*, apply a 6-inch layer of arborist wood chip mulch and water regularly to maintain moisture, control erosion and protect surface roots.
 - » For *any vehicle or equipment access*, apply a minimum 1-inch steel plate or 4-inch thick timber planking over 2-3 inches of arborist wood chip mulch, or a minimum ¾-inch plywood over 6-8 inches of arborist wood chip mulch to protect roots and root zone soil from disturbance or compaction.

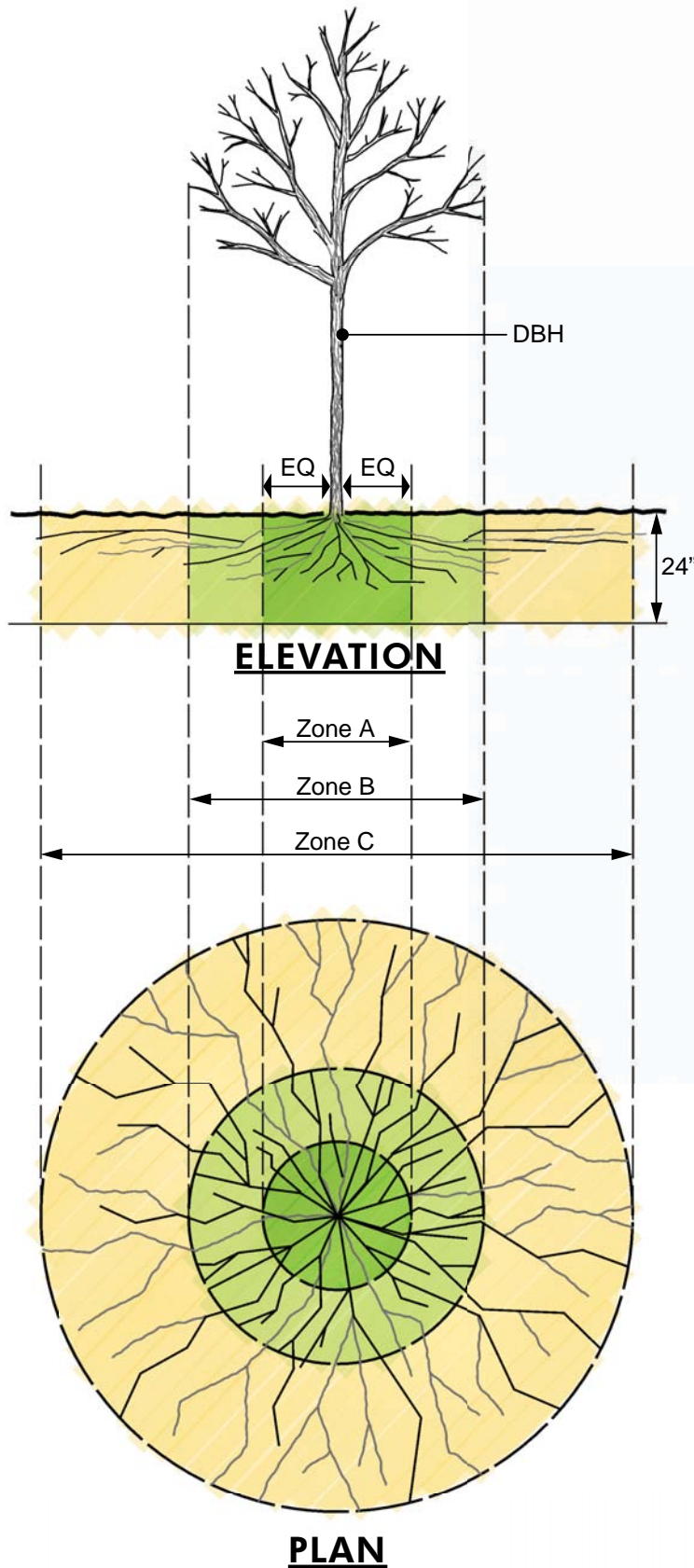

TREE PROTECTION ZONES:



Zone A - Critical Root Zone
The area under a tree whose diameter at breast height (DBH) measures 1 foot per 1 inch of DBH from the trunk outwards and twenty-four inches in depth. See table below for examples:

Tree Diameter	CRZ radius	CRZ diameter (including tree trunk)
2 inches	2 feet	4.5 feet
6 inches	6 feet	13 feet
20 inches	20 feet	42 feet
50 inches	50 feet	105 feet



Zone B - Drip Line
The area on the ground below the tree in which the boundary is designed by the edge of the tree's crown. For young trees, Zone A and B may be one and the same.



Zone C - Feeder Root Zone
The area under a tree whose diameter measures 2 feet per one inch of DBH from the trunk outwards and 24 inches in depth. For example, for a 10 inch DBH tree, the Feeder Root Zone is at least 20 feet in diameter and 24 inches deep.

Tree Protection Zone (TPZ)

"Tree Protection Zone" is an arborist defined area surrounding the trunk intended to protect the roots and soil to ensure future tree health and stability. A TPZ consists of a minimum Zone A or B, whichever is greater, or other area as defined by a project arborist or urban forester.

figure 4.3

Tree root protection zone.
Source: AHBL

4

4.2 Re-establishing Native Vegetation

4.2 Re-establishing Native Vegetation

Soil and vegetation protection areas that have been disturbed and do not have vegetation of sufficient size, quantity, and quality to achieve the necessary coverage may require soil enhancement and replanting with native trees and vegetation in order to achieve the full hydrologic benefits of the site (see Section 6.2: Amending Construction Site Soils for soil guidelines).

4.2.1 Existing Plant Evaluation and Site Preparation

Consult a qualified urban forester or landscape architect to develop a long-term vegetation and soil management plan to ensure that trees are appropriately identified for retention based on tree condition, site management objectives, and public safety. Depending on site objectives, trees may need to be evaluated by a qualified arborist or qualified urban forester for:

- Major pest or pathological problems.
- Extensive crown damage.
- Weakly attached co-dominant trunks when located in areas where failure could cause damage or safety problems.
- Unsound trunks with extensive decay or damage.
- Potential for wind damage in the post development condition.

(Matheny and Clark, 1998)

Trees identified as having significant wildlife value, such as snags and nesting sites, should be retained regardless of the health of the tree, unless the tree poses an imminent safety threat, as determined by a qualified arborist or urban forester.

Intensive inventories and individual tree health evaluation is generally limited to areas where trees can damage existing or proposed structures. Depending on the physical setting, regulatory requirements, aesthetics, and other specific management needs, inventories and subsequent evaluations may be necessary in portions or all of the protection area's interior. If inventories and management plans indicate deficiencies in protected area vegetation structure, removing unhealthy trees may be desirable to free

growing space, encourage new seedlings and create age and species diversity. The site should be prepared for planting by removing invasive species, stabilizing erosion areas, and enhancing soil with compost amendment where necessary.

4.2.2 Plant Selection

The native vegetation species should be selected based on the underlying soils and the historic, native plant community type for the site. Coniferous trees provide greater interception, storage, and evaporation potential in the wet months and should be the major component of the protection area, if ecologically compatible with the site. A single species of vegetation should not be used for replacement purposes.

The following general guidelines are recommended for installing a self-sustaining native plant community that is compatible with the site and minimizes long-term maintenance requirements:

- The planting should provide a multilayer canopy structure of large trees, small trees and shrubs.
- Climax species, such as Douglas fir (*Pseudotsuga menziesii*), should be emphasized on drier sites with more sun exposure, and western red cedar (*Thuja plicata*), western hemlock (*Tsuga heterophylla*) or sitka spruce (*Picea sitchensis*) on wetter sites with less sun exposure.
- For many sites, a ratio of 2 evergreens to 1 deciduous tree will provide a mix similar to native forests.
- To create a multilayer canopy, install 50 percent large structure trees to 50 percent small trees and shrubs.
- Space large trees at 15-20 feet and shrubs at 4 feet on center.
- The installation should be designed to develop a dense closed canopy (when compatible with the site), to provide interception and evaporation of precipitation in the wet months and shade the site to exclude invasive vegetation species (personal communication Bob Barnes August, 2004).

Plants should conform to the standards of the current edition of American Standard for Nursery Stock, as approved by the American Standards Institute, Inc. (current edition: ANSI Z60.1-2004). All plant materials for installation should:

- Have normal, well-developed branches and a vigorous root system.
- Be healthy and free from physical defects, diseases, and insect pests.
- Not have weakly attached co-dominant trunks.

4.2.3 Plant Size

Selecting the optimum size of plant material for installation includes several factors. In general, small plant material requires less careful handling, less initial irrigation, experiences less transplant shock, is less expensive, adapts more quickly to a site, and transplants more successfully than larger material (Sound Native Plants, 2000). Smaller plant material is, however, more easily overgrown by weeds and invasive species, such as reed canary grass, is more susceptible to browse damage, and is more easily damaged by maintenance personnel or landowners (Kantz, 2002). Accordingly, the following recommendations are provided:

- Where invasive species are not well established, weeds and browsing are controlled regularly, and maintenance personnel and landowners are trained in proper maintenance procedures, smaller material will likely have a lower mortality rate, is less expensive, and is recommended. Small trees and shrubs are generally supplied in pots of 3 gallons or less.
- Where invasive species are prevalent and weed and browse control is not ensured, larger plant material is recommended. Larger plants will require additional water during the establishment period.
- For larger tree stock, coniferous and broadleaf evergreen material should be a minimum of three feet in height and deciduous trees should have a minimum caliper size of one-inch (Kantz, 2002).
- All new installations require monitoring to ensure application of supplemental water necessary during establishment. Larger stock commonly requires additional watering (volume and/or frequency) during establishment.

Native species should be used for vegetation and soil protection areas not adjacent to residential lots or commercial development. Depending on aesthetic needs, cultivars adapted to the region for hardiness may be used in transition areas between protection areas and structures. For growth characteristics and site suitability of trees and shrubs native or adapted to the Pacific Northwest, see Appendix 1: Bioretention Plant List and Appendix 2: Street Tree List.

4.2.4 Reference Documents for Planting

Vegetation restoration/planting methods should conform to published standards. The following guidance documents are provided as examples:

- Restoring the Watershed: A Citizen's Guide to Riparian Restoration in Western Washington, Washington Department of Fish and Wildlife, 1995.
- Plant It Right Restoring Our Streams, Washington State University Extension <https://pubs.wsu.edu/> (go to Natural Resources then Watersheds).
- Integrated Streambank Protection Guidelines, Washington Department of Fish and Wildlife, 2000.
- Surface Water and Groundwater on Coastal Bluffs: A Guide for Puget Sound Property Owners, Washington Department of Ecology, Shorelands and Coastal Zone Management Program Publication No. 95-107, 1995.
- Vegetation Management: A Guide for Puget Sound Bluff Property Owners, Washington Department of Ecology, Shorelands and Coastal Zone Management Program Publication No. 93-31, 1993.
- Relative Success of Transplanted/Outplanted Plants, Sound Native Plants, 2000.

Plants installed in the fall generally outperform late winter or spring plantings. In fall, the soil is warmer and more aerated than in the spring and transpiration requirements are less than the spring and summer months. During the fall and winter, plants can develop sufficient root systems, recover from transplant shock, and prepare for the top growth and water demands of the growing season (Sound Native Plants, 2000).

4

4.3 Maintenance

4.3 Maintenance of Protected Areas

In a low impact development, native vegetation and soil protection areas are stormwater management facilities. Clearly written management plans and protection mechanisms are necessary for maintaining the benefits of these areas for the long term. Some of the mechanisms for protection include dedicated tracts, conservation and utility easements, transfer to local land trusts (large areas), and homeowner association covenants. Property owner education should be incorporated in all of these strategies.

Site management during establishment requires inspection on a specified (monthly or quarterly) basis to monitor weed control requirements, watering, mulch coverage, and maintenance of other erosion and sediment control measures as well as replacement of dead plant material for a minimum of 3 years from installation in order to achieve a minimum 80 percent survival of all planted vegetation. If during the three-year period survival of planted vegetation falls below 80 percent, additional vegetation should be planted as necessary to achieve the required survival rate. Additionally, the likely cause of the high rate of plant mortality should be determined (often poor soils and compaction) and corrective actions taken as needed to ensure plant survival. If it is determined that the original plant choices are not well suited to site conditions, these plants should be replaced with plant species that are better suited to the site.

Maintenance of soil stormwater functions and plant health requires continuing surface inputs of organic matter to feed the soil ecosystem. In natural areas, leaving fallen leaves and woody material provides that input. In areas that have been disturbed or replanted (with native or landscape plantings), applying arborist wood chip mulch annually until the understory canopy closes (3-5 years) will feed the soil, reduce water stress, and prevent weed invasion. In areas converted to turf, blowing fall leaves into beds and using mulching mowers (leaving clippings on-site) and minimal fertilization with organic-based products will maintain soil health.

Ongoing protection of native vegetation areas also requires preventing impacts from adjacent developed areas. Best practices include developing an Integrated Pest Management Plan that avoids use of herbicides, fungicides, and insecticides on turf or landscaped areas, treating road or parking runoff with bioretention swales or other methods before it flows into natural areas, and preventing compaction (by foot or equipment) of turf and landscape bed areas that may be colonized by adjacent tree roots.

Permanent signs should be installed explaining the purpose of the area, the importance of vegetation and soils for managing stormwater, and that removal of trees or vegetation and compaction of soil is prohibited within the protected area. Permanent fencing, rock barriers, bollards or other access restriction at select locations or around the perimeter of the vegetation retention areas may be required to limit encroachment.

5

CHAPTER

Precision Site Preparation, Construction & Inspection of LID Facilities

Precision Site Preparation	5.1
Techniques to Minimize Site Disturbance	5.2
Inspection of LID Facilities	5.3
Construction Sequencing of LID Facilities	5.4

Protecting native soil and vegetation, minimizing soil compaction, and retaining hydrologic function during the site preparation and construction phases presents some of the most significant challenges within the development process. Upper soil layers contain organic material, soil biota, and a structure favorable for storing and slowly conducting stormwater down gradient as interflow or shallow groundwater flow. Clearing and grading exposes and compacts underlying subsoil, producing a site with significantly different hydrologic characteristics. On till soil, precipitation is rapidly converted to overland flow. On project sites with native outwash soils and vegetation, where surface and interflow are negligible, the increase in overland flow can be greater than native till conditions if impervious areas are not minimized and soil structure is not protected for infiltration.

In addition to hydrologic modifications, sediment yield from clearing, grading, and other construction activities can significantly affect receiving waters. Gammon found that stream biota were significantly reduced at suspended solids levels of 50-80 mg/L (Corish, 1995). Schueler reported a median total suspended solids concentration of 4,145 mg/L leaving construction sites without erosion and sediment control and 283 mg/L at sites with controls (the range of concentrations with controls—11-2,070 mg/L—in the study was highly variable) (Corish, 1995). Typically, sediment and erosion are managed through structural practices; however, reliance on structural approaches alone to compensate for widespread vegetation loss can add unnecessary construction costs and may not provide adequate protection for aquatic habitat and biota.

5

5.1 Precision site preparation

5.1 Precision Site Preparation

Several factors, including topography, hydrology, zoning density and plat design, financial disbursements, bond release, and housing type, influence the timing and extent of clearing and grading activities. The scope of this section does not include the regulatory and market structure influencing clearing and grading, but rather focuses on planning and implementation techniques to reduce impacts to native soils, vegetation, and hydrology on the site. Precision site preparation refers to a process where mass clearing and grading (that increases the probability of high sediment loads released from the property, excessive soil compaction and sediment management expense) is replaced with more targeted clearing and grading and sequencing that protects native soils and vegetation, minimizes exposure soil, and reduces soil compaction.

Proper installation and maintenance of erosion and sediment **best management practices** (BMPs) are required during the clearing, grading, and construction phases of a project. For detailed guidelines and specifications for erosion and sediment control BMPs see Volume I Minimum Technical Requirements and Site Planning, Section 2.5 and Volume II, Chapter 3 of Ecology's 2012 *SWMMWW*.

New compost-based erosion and sediment control BMPs (compost blankets, berms and socks) are effective and have the added value of bringing compost on-site that can later be used to meet the Department of Ecology's post-construction soil amendment requirements (see Section 6.2: Amending Construction Site Soils). These compost BMPs are described in the Ecology manual referenced above. More detailed specifications are available in the US EPA's National Menu of stormwater BMPs under the Construction BMPs heading at: <http://cfpub.epa.gov/npdes/stormwater/menuofbmps/>.

A short description and examples are shown in "Erosion Control with Compost," available at: http://www.buildingsoil.org/tools/Erosion_Control.pdf

5.2 Techniques to Minimize Site Disturbance

Planning and implementation techniques to minimize site disturbance fall into four categories:

1. Efficient site design.
2. Construction planning (e.g., site preparation, homebuilding, and utility connection).
3. Training.
4. Equipment.

5.2.1 Efficient Site Design

- Reduce the overall development envelope and maximize protection of native soils and vegetation with efficient road layout and cluster design (see Chapter 3: Site Planning and Layout).
- Develop a Soil Management Plan during design that maps both soil protection areas and areas to be disturbed, and describes measures to be taken either for protection or restoration of functional topsoil conditions (minimum 12 inches deep) over the entire site (see Section 6.2: Amending Construction Site Soils for guidance on developing a Soil Management Plan).
- Retain natural topographic features that slow and store storm flows.
- Limit overall project cut and fill through efficient road design, lot layout, and drainage and utility siting.
- Minimize cut and fill by orienting the long axis of buildings along contours or staggering floor levels for buildings to adjust to gradient changes.
- Use minimal excavation foundation systems to reduce grading (see Section 6.6: Minimal Excavation Foundation for details).
- Limit clearing and grading disturbance to road, utility, building pad, landscape areas, and the minimum additional area needed to maneuver equipment (a 10-foot perimeter around the building site can provide adequate work space for most activities).
- Limit the construction access to one route if feasible, and locate access where future roads and utility corridors will be placed. If permeable pavement is used, protect subgrade from sedimentation and compaction (see Section 6.3: Permeable Pavement for details).

5.2.2 Implement Effective TESC and Coordinate Planning and Activity Among Construction Entities

Some of the protection measures listed below are required in Construction Stormwater Pollution Prevention Plans. For additional detail see Volume II of the 2012 *SWMMWW*.

- Begin clearing, grading, and heavy construction activity during the driest months and conclude by late fall when rainfall and associated soil compaction, erosion, and sediment yield from equipment activity increases. Fall is also when conditions are most favorable for establishing vegetation.
- Plan efficient sequencing of construction phases to reduce equipment activity and potential damage to soil and vegetation protection areas.
- Establish and maintain temporary erosion and sediment controls (TESC) before or immediately after clearing and grading activity begins. Re-establish TESC around homebuilding activities. Maintain an approved plan set with contact for project TESC manager or specialist on site.
- Phase project to complete operations in one section of the site before clearing and grading the next. Project phasing is challenging when coordinating utility, road, and other activities (Corish, 1995). The greatest potential to implement and benefit from phasing will be on large projects where extensive exposed areas are difficult to stabilize over long periods.
- Map native soil and vegetation protection areas on all plans and delineate these areas on the site with appropriate fencing to protect soils and vegetation from clearing, grading, and construction damage. Fencing should provide a strong physical and visual barrier of high strength plastic or metal and be a minimum of 3-4 feet high (see 2012 *SWMMWW* BMP C103). Silt fencing or a compost berm is necessary in addition to, or incorporated with, the barrier for erosion control.
- To reduce soil compaction, erosion, and sediment impacts, establish efficient construction access roads and cover with aggregate base material immediately after grading. Maintain clear access with barriers and signage to keep equipment traffic on designated access to the greatest extent possible.
- Stockpile materials in areas designated for clearing and grading (avoid areas within the development envelope that are designated for bioretention or other infiltration areas).
- Stockpile and reuse excavated topsoil to amend disturbed areas where native soil characteristics merit (see Section 6.2: Amending Construction Site Soils for details).
- Small stockpiles of soil should be covered and larger piles covered or seeded (if adequate vegetation coverage can be attained before wet season) for erosion control during wet months and in wind prone areas.
- Contact the local conservation district or native plant salvage program for salvaging and reusing native plants from cleared areas.
- Inspections:
 - » Conduct a pre-construction inspection to determine that adequate barriers have been placed around vegetation protection areas and structural controls are implemented properly.
 - » Routine inspections should be conducted to verify that structural controls are maintained and operating effectively throughout construction, and that soil structure and vegetation are maintained within protection areas. If controls are not adequately protecting designated areas, adjust existing or implement additional protection measures.
 - » Conduct a final inspection to verify that re-vegetated areas are stabilized and that stormwater management systems are in place and functioning properly (Corish, 1995).

See Section 5.3: Inspection of LID facilities for more inspection guidelines.

5.2.3 Adequate Training of Personnel Implementing Project Activities

- Install signs to identify limits of clearing and grading, and explain the use and management of natural resource protection areas.
- Meet and walk property with equipment operators, project foremen, contractors, and sub-contractors regularly to clarify construction boundaries, limits of disturbance, and construction activities. Pay particular attention to subgrade preparation for permeable pavement and bioretention installations and techniques to avoid subgrade compaction (see Section 6.1: Bioretention and Section 6.3: Permeable Pavement for details).
- Require erosion and sediment control training for operators.

5.2.4 Proper Equipment

Research in the agricultural setting indicates that ground contact pressure generally determines the potential for compaction in the upper 6-8 inches of soil while total axle load can influence compaction in the deeper subsoil layers. Vehicles with tracks or tires with axle loads exceeding 10 tons per axle can compact soils as deep as 3 feet (DeJong-Hughes, Moncrief, Voorhees and Swan, 2001). A majority of the total soil compaction (70-90 percent) can occur in the first pass with equipment (Balousek, 2003).

To minimize the degree and depth of compaction, use equipment with the least ground pressure to accomplish tasks. For smaller projects, many activities can be completed with mini-track loaders or excavators that are more precise, require less area to operate, exert less contact pressure than equipment with deep lugged tires, and have lower total axle weight (personal communication, James Lux, August 2004).

5.3 Inspection of LID Facilities

5.3.1 Amending Construction Site Soils

Verification of soil protection or restoration over the entire site falls into four steps (Stenn, *Building Soil: Guidelines and Resources for Implementing Soil Depth and Quality BMP T5.13 in Ecology's SWMMWW*, 2003 and Seattle Department of Planning and Development, CAM 531 Post Construction Soil Management, 2009):

1. Pre-construction conference
 - Verify soil management plan is in place that identifies soil and vegetation protection zones on all plans and describes quantities of compost amendment, stockpiled or imported topsoil, and mulch to be used to restore all construction-disturbed soil areas at end of project.
2. Visits during construction
 - Verify that protection areas have been fenced and not impacted.
 - Verify soil management plan has been communicated to all contractors and sub-contractors.
 - Verify that equipment is kept to road base wherever possible and TESC is maintained.
3. Pre-planting visit (after soil amendment)
 - Verify that protection areas have not been impacted.
 - Inspect delivery tickets for compost, topsoil, and mulch to verify they match quantities on soil management plan.
 - Probe with shovel or bar to verify soil in all disturbed areas is un-compacted to at least 12-inch depth (shovel enters 12 inches with inspector's weight).
 - Dig several holes to visually verify brown color at least 8 inches deep, indicating that compost or compost-amended topsoil has been incorporated to at least that depth.
4. Post-construction visit
 - Verify that amended or restored topsoil has not been compacted by equipment traffic.
 - Verify mulch placed over landscape beds after planting.

5.3.2 Bioretention

Inspection and verification criteria and timing can be organized into five site visits. Also included below is a critical first step for reviewing and confirming the inspection and verification process as part of an LID pre-construction review (Seattle Public Utilities, Construction Inspection Checklist for Stormwater Code Compliance, 2010; and Hinman, LID Technical Workshop Series for Puget Sound, 2011).

Pre-construction review

- Set guidelines, expectations, and timing for inspections.
 - Discuss construction sequencing and field change process.
 - Review checklists.
 - Include developer, builder, utilities, plan, and critical areas reviewers, and inspectors in pre-construction review.
 - Determine training needs for review, inspection, and construction personnel. For example, the landscapers may need to be briefed on the location and care of permeable pavement installations to prevent bioretention soil media (BSM) placement on and clogging of the pavement.
 - Clearly identify lay-down and staging areas on plans and mark in field.
 - Confirm where all stormwater management requirements are located in the plans. For example, within an LID project plan set and specifications there may be stormwater requirements within the landscaping guidelines.
- Downstream inlets and catch-basins are protected.
 - Bioretention areas are clearly marked on-site and barriers are adequate to prevent equipment from entering the bioretention area.
 - Rough grading and bioretention dimensions are to plans.
 - Side slopes and other dimensions are per specifications and sufficient to accommodate required BSM, mulch, and ponding depths.
 - Curb-cuts openings (if used) are blocked to prevent construction stormwater from entering bioretention areas.
 - Protective measures are in place for subgrade if BSM will be installed later in the construction process (e.g., plastic sheeting, mulch or a minimum of 6 inches of soil as a barrier to sedimentation). If soil is placed as a protective layer, and under-drain is present, cover the under-drain temporarily with filter fabric to prevent sedimentation.
 - BSM is protected from contamination and stormwater runoff if stockpiled on site.
 - Implement any field changes (the field change process should have been confirmed during pre-construction meetings).

VISIT ONE (TESC and grading)

Confirm:

- Native/existing soils are comparable to the design assumptions and specifications in the stormwater site plan. A geotechnical engineer, the Engineer of Record or other qualified design professional should conduct evaluation.
- TESC is correctly installed and working properly to prevent runoff to the bioretention areas from within project and from adjacent properties. Confirm adjacent permeable pavement and other infiltration areas are protected.

VISIT TWO (BSM, subgrade and bioretention infrastructure verification)

Confirm:

- TESC is correctly installed and working properly to prevent runoff to the bioretention areas from within project and from adjacent properties.
- Subgrade soil is free of construction runoff fines. If sediment has entered the bioretention area and contaminated the subgrade, remove subgrade soil to a depth that removes introduced fines. Replace subgrade soil with approved BSM (appropriate subgrade condition should be approved by Engineer of Record).
- Under-drain(s), if installed, and overflow(s) are at proper elevations and locations.
- The aggregate backfill material for the under-drain (if under-drain is installed) is free of fines. If fines are present, remove top 6 inches of backfill and replace with aggregate per design.

5 5.3 Inspection of LID facilities

- Subgrade soil has been scarified to minimum of 3 inches (applies to bioretention areas with and without under-drains).
- BSM meets composition guidelines. If using the guidelines in Section 6.1.2.2: Bioretention soil media, pre-placement laboratory analysis for saturated hydraulic conductivity of the BSM is not required. Verification of the mineral aggregate gradation, compost guidelines and mix ratio in Section 6.1.2.2: Bioretention soil media should be provided to verify performance guidelines in that section. Collect sample for testing if required. If the BSM uses a different mineral aggregate gradation, compost guidelines or mix ratio than Section 6.1.2.2: Bioretention soil media, then the verification of the BSM composition and hydraulic conductivity should be provided through laboratory testing of the material to be used in the installation. Verification should be with a grain size analysis of the mineral aggregate, compost quality analysis and verification of aggregate to compost ratios. BSM composition guidelines should be approved by Engineer of Record. See sections 6.1.2.1: Determining subgrade and bioretention soil media design infiltration rates and 6.1.2.2: Bioretention components for testing protocol.
- Excavated cell subgrade does not have standing water or is not saturated, and that BSM is not saturated when placed.

VISIT THREE (BSM placement and pre-planting)

Confirm:

- TESC is correctly installed and working properly to prevent runoff to the bioretention areas from within project and from adjacent properties.
- BSM is placed per specifications and meets depth and compaction requirements. If depth cannot be verified through other means, expose BSM profile to subgrade. A penetrometer can be used for compaction when properly calibrated and with appropriate training.
- Mulch (if required) is placed immediately after placement and before planting (e.g., placement of BSM and mulch during summer months and fall planting) to prevent weed establishment.

- Sediment has not entered the bioretention area. If sediment is present, the contractor should remove and replace the top layer of the BSM to a depth that removes all sediment (typically 3-6 inches). Engineer of Record should approve adequate removal of sediment and infiltration capacity.
- Side slopes and other dimensions are per specifications.

VISIT FOUR (post-planting and mulch)

Confirm:

- Plant type and density per plans.
- Mulch type and depth (typically 2-3 inches).
- No sediment is accumulated on the mulch.
- Finished bioretention cell or swale elevation (including mulch) is below sidewalks, curbs, driveways, and other pavement per plans (typically 1 inch).
- There is not excessive weed or invasive plant establishment (see Appendix 4 for various levels of service and weed management).
- All pipes, culverts, conveyance systems, and flow control structures are free and clear of debris.

VISIT FIVE (post-construction and overall site inspection)

Confirm:

- Final grade.
- Contributing area size is per plans and stabilized.
- BSM is not clogged and infiltration rate is adequate through visual assessment of sediment accumulation and ponding duration following precipitation events. If infiltration tests are deemed necessary because of excessive sedimentation, compaction or ponding, conduct spot checks with a double ring infiltrometer or full-scale flood test as determined by the Engineer of Record.
- Vegetation vigor and survival rate is per specifications.
- Schedule removal of TESC (TESC should remain in place at least 3 months following bioretention completion).
- That the operation and maintenance plan is in place.

5.3.3 Permeable Pavement

Inspection and verification timing and processes fall into four site visits. Also included below is a critical first step for reviewing and confirming the inspection and verification process as part of an LID pre-construction review (Seattle Public Utilities, Construction Inspection Checklist for Stormwater Code Compliance, 2010 and Hinman, LID Technical Workshop Series for Puget Sound, 2011).

Pre-construction conference

- Set guidelines, expectations, and timing for inspections.
- Discuss construction sequencing and field change process.
- Review checklists.
- Include developer, builder, sub-contractors, utilities, plan and critical areas reviewers, and inspectors in pre-construction review.
- Determine training needs for review, inspection, and construction personnel. For example, the landscapers may need to be briefed on the location and care of permeable pavement installations to prevent BSM placement on, and clogging of, the pavement.
- Clearly identify lay-down and staging areas on plans and mark in field.
- Confirm where all stormwater management requirements are located in the plans. For example, within an LID project plan set and specifications, there may be stormwater requirements within the landscaping guidelines.

VISIT ONE (subgrade preparation and geotextile and aggregate base placement)

Confirm:

- TESC is correctly installed and working properly to prevent run-on to the permeable pavement areas from within project and from adjacent properties. Note: if sandbags are used for TESC, inspect and replace sandbags as necessary to prevent breakage, sand accumulation on pavement, and clogging.
- Traffic control measures are in place to protect permeable paving.

- Adjacent permeable pavement, bioretention or other infiltration areas are protected from sediment, construction debris, material storage, and construction traffic.
- Downstream catch-basins are protected.
- Methods for treating over-compacted areas (e.g., dedicated travel ways for construction equipment) have been determined as construction is completed. See Section 6.3.2.1: Common components, design and construction criteria for permeable pavement (subgrade section) for compaction guidelines.
- Measures are in place to protect subgrade, including travel ways clearly defined, protective cover (e.g., steel plates or aggregate base) where construction vehicles must access subgrade for utility or other construction activity.
- Final excavation is performed with construction equipment operating on grade that is 1 foot above final grade.
- Final subgrade excavation is completed during dry weather.
- Prior to placement of geotextile (if specified) and aggregate base, verify that subgrade soil is free of construction sediment. If sediment is present, the contractor should remove the top layer of the subgrade to a depth that removes all sediment (typically 3-6 inches) and replace with material per design. Adequate removal of sediment should be approved by Engineer of Record.
- Final subgrade infiltration rate and/or compaction effort meets design assumptions. Infiltration rate and compaction effort should be approved by Engineer of Record.
- Final elevation checks are complete per construction drawings.

VISIT TWO (geotextile and aggregate base placement)

Confirm:

- Geotextile for strength requirements and that installation (e.g., overlap) is per specifications, if specified.
- If subgrade check-dams are specified, berm material, spacing, dimensions, and method for keying to subgrade are per construction plans.

5 5.4 Construction sequencing of LID Facilities

- Under-drains are installed per drawings and drain to an approved discharge point, if specified.
- Aggregate base are per specifications and choker and leveling course materials (if specified) are per specifications.
- Depth of aggregate layer is per specifications.
- Geotextile is wrapped over aggregate base and secured per specification to temporarily protect base from sediment. Remove geotextile prior to installing permeable surface.
- Adjacent areas are stabilized to protect aggregate base from sediment.

VISIT THREE (pavement placement)

Confirm:

- TESC is correctly installed and working properly to prevent run-on to the permeable pavement areas from within project and from adjacent properties.
- Traffic control is in place to route foot and vehicular traffic around pavement until pavement is fully cured/stabilized.
- Materials for aggregate base and leveling or choker courses (if specified) and compaction of the aggregate are to specification.
- Pavement sources and materials submittals have been received and approved by Engineer of Record.
- If required, placement personnel certifications have been received and approved.
- If specified, test section is completed and accepted per specification prior to placement of full installation.
- For full installation, pavement materials are placed per specifications and accepted test section (see Section 6.3: Permeable Pavement for guidelines).
- Geotextile (if specified) is wrapped over pavement and secured per specification to temporarily protect pavement from sediment. Remove geotextile once overall site is stabilized.
- Sediment and debris deposited on pavement has been removed and infiltration capability is per specification.
- Protection measures and traffic control removed.

VISIT FOUR (post-construction and overall site inspection)

Confirm:

- Final grade.
- Overall site is stabilized to prevent construction or landscaping sediment from entering permeable pavement area.
- Removal of TESC is scheduled, and verify that the operation and maintenance plan is in place.

5.4 Construction Sequencing of LID Facilities

Proper construction sequencing and correctly implementing specific techniques for building LID facilities are critical for project success. LID facilities are often part of, or adjacent to, the road ROW and building sites, and require special attention to the construction process for preventing sedimentation and compaction.

The following section focuses on bioretention within the right-of-way (ROW) and permeable pavement. Both of these practices are associated with, and impacted by, several other construction activities and require coordinated planning, sequencing, and inspection. In contrast, green roofs, rainwater collection and reuse, and LID foundations are within the building envelop and are impacted by relatively fewer activities.

Specific sequencing and construction techniques will be determined by individual site conditions and constraints; however, the below guidelines provide a framework and major considerations for the construction process. The overall process for LID sequencing and construction are:

- Consider and plan the construction sequence to prevent compaction and sedimentation to LID facilities with the project team (permitting jurisdiction, inspector(s), owner, developer, construction manager and foreman).

- During the construction planning phase, identify the specific (and perhaps unique) construction processes necessary to prevent compaction and sedimentation. This and the previous bullet are the most important steps for successful implementation.
- Provide clear and robust signs to identify limits of clearing and grading, and explain the use and management of the facilities.
- Provide robust construction barriers to prevent entrance and compaction of bioretention areas and, where possible, permeable pavement.
- Plan to meet and walk property with equipment operators regularly to clarify construction boundaries, limits of disturbance, and construction activities. Particular attention must be given to subgrade preparation for permeable pavement and bioretention installations, and techniques to avoid subgrade compaction (see Section 6.1: Bioretention and Section 6.3: Permeable Pavement for details).
- Install robust construction barriers and signage (e.g., chain-link fencing) around bioretention areas to prevent equipment from entering and compacting subgrade soil or BSM. Install sediment and erosion control (e.g., sediment fence with compost sock) in conjunction with construction barriers.
- Meet with homebuilder and construction foreman to identify bioretention areas and discuss their function as infiltration facilities.

Residential: Site sloping to bioretention facility in dense development (8 du/acre or greater):

This presents a significantly more difficult construction scenario requiring careful planning, personnel management, and sequencing. As with the above scenario, develop a performance bond (public and private development) that defines proper functioning condition and testing to demonstrate performance when construction is complete. There are two primary decision pathways:

1. Divert flows around facility and treat during construction. This will require a parallel storm system or temporary conveyance to treatment/storage area(s)
2. Partially complete and allow storm flows through facility. *This method should only be used if there is no other alternative.*

Without under-drain

- Delineate or partially grade to define facility.
 - Install robust construction barriers and signage (e.g., chain-link fencing) around bioretention areas to prevent equipment from entering and compacting subgrade soil or BSM. Install sediment and erosion control (e.g., sediment fence with compost sock) in conjunction with construction barriers.
 - Keep construction traffic off area (mitigating deep compaction may not be possible).
 - Stabilize upslope construction area as best as possible by reducing flow distances and capturing sediment on slope (e.g., silt fence or berms) or deep mulch (e.g., hog fuel).
- Develop a performance bond (public and private development) that defines proper functioning condition and testing to demonstrate performance when construction is complete.
 - If bioretention area can be protected from compaction during construction, complete bioretention area with roads, utilities, and other storm infrastructure before completing homes.
 - Clearly delineate building site entrance.

5.4.1 Bioretention

Minimizing sedimentation, removing sediment from bioretention areas, and replacing any soil removed with new BSM when project is complete are necessary for a proper functioning system. However, deep compaction in bioretention areas is very difficult, if not possible, to mitigate and must be prevented (see Section 5.2.4: Proper equipment for compaction depths). The following provides typical construction scenarios and outlines compaction and sedimentation management strategies.

Residential: Site flat or sloping away from bioretention facility:

5

5.4 Construction sequencing of LID Facilities

- If flows are allowed through facility, leave temporary grade at least 6 inches above final grade (protects final subgrade from sedimentation). Facility can be further protected by lining with plastic (stormwater is conveyed to storage/treatment area) or mulch (water is allowed to infiltrate, but sediment is captured in mulch).
- Additional sediment control can be used, such as a temporary forebay to localize sedimentation.
- Once construction is complete and upslope area stabilized, remove liner or mulch and excavate to final grade (sediment captured in 6 inches of soil profile is removed at final excavation). Final subgrade condition should be approved by the Engineer of Record.

With under-drain

- Place under-drain and aggregate filter and bedding layer while maintaining a temporary grade at least 6 inches above final grade in bioretention area surrounding excavation.
- Place protective covering (plastic or filter fabric) over under-drain aggregate filter and bedding layer and cover with a protective layer of sandy aggregate.
- Follow guidelines in construction scenario above without under-drain.

Agreements

Partial excavation and completion of facility after homes are finished and landscaping stabilized requires clear agreement among the developer, homebuilder, and jurisdiction.

5.4.2 Permeable Pavement

Various strategies are described below to protect permeable pavement installations during construction. Other techniques or combinations of the below techniques are possible. Additional measures may be necessary for adequate protection depending on the project setting. For example, tire washing stations for construction equipment or separate haul roads may be appropriate as stand-alone strategies or incorporated with other techniques.



figure 5.1

Proper erosion and sediment control for bioretention installation. Note the pervious concrete sidewalk is protected with filter fabric and the curb inlets to the bioretention area are blocked until site is stabilized.

Source: Curtis Hinman

ROADS AND SIDEWALKS (where roads are not used for construction access)

- Install robust construction barriers and signage (e.g., chain-link fencing) around permeable pavement areas to prevent equipment from entering and compacting subgrade soil. Install sediment and erosion control (e.g., sediment fence with compost sock) in conjunction with construction barriers.
- Meet with the builder, contractor and sub-contractors, and construction foreman to identify permeable pavement areas, discuss their function as infiltration facilities, and confirm methods to protect pavement from sediment and structural damage.
- Determine threshold for designating pavement as clogged, and methods and responsible party for cleaning pavements if clogged.
- Protect subgrade and install base and pavement. See Section 6.3.2.1: Common components, design and construction criteria for permeable

pavement for techniques to minimize subgrade compaction and Section 6.3.2.2: Types of permeable pavement for installation techniques of specific pavement types.

- Cover with plastic.
- Cover with geotextile and secure. Sand bags are not recommended for securing protective covers (sand will deposit on pavement when bags break and cause clogging). If used, sand bags must be maintained regularly.
- Close and protect area.
- Maintain good TESC until site is stabilized.

ROADS (permeable concrete or asphalt used for construction access)

Option 1

- Install robust construction barriers (e.g., chain-link fencing) to control entrance and sediment deposition. Install sediment and erosion control (e.g., sediment fence with compost sock) in conjunction with construction barriers. Note that compost socks and sand bags must be maintained to prevent breakage and deposition of sand or compost on the permeable pavement.
- Meet with the builder, contractor and sub-contractors, and construction foreman to identify permeable pavement areas, discuss their function as infiltration facilities and confirm methods to protect pavement from sediment and structural damage.
- Protect subgrade and Install open graded asphalt treated base (ATB). See Section 6.3.2.1: Common components, design and construction criteria for permeable pavement for techniques to minimize subgrade compaction.
- Cover and secure protective fabric over open graded ATB and use for construction access.
- Maintain good TESC until site is stabilized.
- Complete construction, remove protective fabric, clean where necessary, and complete wearing course over ATB. See Section 6.3.2.2: Types of permeable pavement for installation techniques of specific pavement types.
- The Engineer of Record should inspect the site and test to confirm that the ATB is clean and

infiltrating adequately. Testing may include, but is not limited to, spot testing with ASTM 1701 or applying water from water trucks or hydrants at selected locations.

Option 2

- Install robust construction barriers (e.g., chain-link fencing) to control entrance and sediment deposition. Install sediment and erosion control (e.g., sediment fence with compost sock) in conjunction with construction barriers. Note



Pervious concrete sidewalk protected with filter fabric that is placed on subgrade, wrapped over and secured to the hardened concrete during construction

Source: Curtis Hinman

figure 5.2

5

5.4 Construction sequencing of LID Facilities

that compost socks and sand bags must be maintained to prevent breakage and deposition of sand or compost on the permeable pavement.

- Meet with the builder, contractor and sub-contractors, and construction foreman to identify permeable pavement areas, discuss their function as infiltration facilities, and confirm methods to protect pavement from sediment and structural damage.
- Protect subgrade and install base and choker course. A choker course will be necessary in this scenario to create an adequate surface for vehicles and protect the geotextile from puncture if the base aggregate is large (e.g., 2-3 inch). See Section 6.3.2.1: Common components, design and construction criteria for permeable pavement for techniques to minimize subgrade compaction and Section 6.3.2.2: Types of permeable pavement for installation techniques of specific pavement types.
- Cover and secure protective geotextile fabric.
- Cover geotextile with protective cover of aggregate.
- Maintain good TESC until site is stabilized.
- Remove the protective aggregate and geotextile and complete pavement installation per specifications.
- The project engineer should inspect the site to confirm that the aggregate base is clean and infiltrating adequately.

ROADS (permeable pavers are used for construction access)

Option 1

- Install robust construction barriers (e.g., chain-link fencing) to control entrance and sediment deposition. Install sediment and erosion control (e.g., sediment fence with compost sock) in conjunction with construction barriers. Note that compost socks and sand bags must be maintained to prevent breakage and deposition of sand or compost on the permeable pavement.
- Meet with the builder, contractor and sub-contractors, and construction foreman to identify permeable pavement areas, discuss their function

as infiltration facilities, and confirm methods to protect pavement from sediment and structural damage.

- Protect subgrade and install sub-base and base. See Section 6.3.2.1: Common components, design and construction criteria for permeable pavement for techniques to minimize subgrade compaction and Section 6.3.2.2 Types of permeable pavement for installation techniques of specific pavement types.
- Cover and secure protective geotextile fabric and 2 inches of base aggregate over the fabric.
- Maintain good TESC until site is stabilized.
- Remove the protective base aggregate and geotextile and complete paver installation per specifications.
- The project engineer should inspect the site to confirm that the aggregate base is clean and infiltrating adequately.

Option 2

- Install robust construction barriers (e.g., chain-link fencing) to control entrance and sediment deposition. Install sediment and erosion control (e.g., sediment fence with compost sock) in conjunction with construction barriers. Note that compost socks and sand bags must be maintained to prevent breakage and deposition of sand or compost on the permeable pavement.
- Meet with the builder, contractor and sub-contractors, and construction foreman to identify permeable pavement areas, discuss their function as infiltration facilities, and confirm methods to protect pavement from sediment and structural damage.
- Protect subgrade and complete paver installation. See Section 6.3.2.1: Common components, design and construction criteria for permeable pavement for techniques to minimize subgrade compaction and Section 6.3.2.2: Types of permeable pavement for installation techniques of specific pavement types.
- Cover and secure protective geotextile fabric over pavers and cover fabric with 2 inches No. 8 stone.

- Protect installation as best as possible particularly from tight radius turns (e.g., strategically placed steel plates or plywood).
- Maintain good TESC until site is stabilized.
- After construction is complete and area is stabilized, remove protective stone and geotextile fabric.
- Project engineer should inspect site to confirm that the paver cells or joints are clean and infiltrating adequately.

Option 3

- Install robust construction barriers (e.g., chain-link fencing) to prevent entrance and compaction with sediment and erosion control (e.g., sediment fence with compost sock).
- Meet with homebuilder and construction foreman to identify permeable pavement areas, discuss their function as infiltration facilities, and confirm methods to protect pavement from sediment and structural damage.
- Protect subgrade, complete paver installation, and allow construction traffic to use finished paver surface. See Section 6.3.2.1: Common components, design and construction criteria for permeable pavement for techniques to minimize subgrade compaction and Section 6.3.2.2: Types of permeable pavement for installation techniques of specific pavement types.
- Protect installation from construction traffic damage (e.g., strategically placed steel plates or plywood where construction vehicles are making tight radius turns).
- Maintain good TESC until site is stabilized.
- Complete construction and stabilize area.
- Wet and vacuum a test portion of the pavement surface with a machine capable of removing 1 inch of the stone from paver joints to remove sediment with associated aggregate in voids. Inspect test area to ensure all sediment is removed (if necessary, adjust vacuum until there are no visible traces of sediment).
- Project engineer should inspect site to confirm that the paver cells or joints are clean and infiltrating adequately.
- Replace aggregate and paver joints.

Agreements

Partial excavation and completion of pavement after homes are finished and landscaping stabilized requires clear agreement among the developer, homebuilder, and jurisdiction.

THIS PAGE
INTENTIONALLY
LEFT BLANK

Integrated Management Practices

6

CHAPTER

Bioretention	6.1
Amending Construction Site Soils	6.2
Permeable Pavement	6.3
Urban Trees	6.4
Vegetated Roofs	6.5
Minimal Excavation Foundations	6.6
Roof Rainwater Collection Systems	6.7

Integrated management practices (IMPs) are the tools used in an LID project for water quality treatment and flow control. Through good site analysis and planning, IMP's are designed to be landscape amenities that take advantage of site topography, existing soils and vegetation, and location in relation to impervious surfaces to reduce stormwater volume, attenuate and treat flows, and ultimately better approximate native hydrologic patterns.

The term IMP is used instead of best management practice or BMP (used for erosion and sediment control and conventional stormwater control structures) because the controls are integrated throughout the project.

6.1 Bioretention

The bioretention concept for managing stormwater originated in Prince George’s County, Maryland in the early 1990s and is a principal tool for applying the LID design approach. The term bioretention was created to describe an integrated stormwater management practice that uses the chemical, biological, and physical properties of plants, soil microbes, and the mineral aggregate and organic matter in soils to transform, remove, or retain pollutants from stormwater runoff. Numerous designs have evolved from the original application; however, there are fundamental design characteristics that define bioretention across various settings.

Bioretention facilities are:

- Shallow landscaped depressions with a designed soil mix and plants adapted to the local climate and soil moisture conditions that receive stormwater from a small contributing area.
- Designed to more closely mimic natural forested conditions, where healthy soil structure and vegetation promote the infiltration, storage, filtration, and slow release of stormwater flows.
- Small-scale, dispersed, and integrated into the site as a landscape amenity.
- An IMP designed as part of a larger LID approach. For example, bioretention can be used as a stand-alone practice on an individual lot; however, best performance is often achieved when integrated with other LID practices.

The terms bioretention and rain garden are sometimes used interchangeably. However, for Washington State the term “bioretention” is used to describe an engineered

The term “bioretention” is used to describe an engineered facility sized for specific water quality treatment and flow control objectives that includes designed soil mixes and perhaps under-drains and control structures.

facility sized for specific water quality treatment and flow control objectives that includes designed soil mixes and perhaps under-drains and control structures (see figure 6.1.1). The term “rain garden” is used to describe a non-engineered landscaped depression to capture stormwater from adjacent areas with less restrictive design criteria for the soil mix (e.g., compost amended native soil) and usually without under-drains or other control structures. Both are applications of the same LID technique and can be highly effective for flow control and water quality treatment.

The term bioretention is used to describe various designs using soil and plant complexes to manage stormwater. The following terminology is used in this manual:

- *Bioretention cells*: Shallow depressions with a designed planting soil mix and a variety of plant material, including trees, shrubs, grasses, and/or other herbaceous plants. Bioretention cells may or may not have an under-drain and control structure and are not designed as a conveyance system. Side slopes are typically gentle; however, side slopes may be steep or vertical in urban areas with space limitations. Ponding depths are typically 6-12 inches.
- *Bioretention swales*: Incorporate the same design features as bioretention cells; however, bioretention swales are designed as part of a system that can convey stormwater when maximum ponding depth is exceeded.
- *Bioretention planter*: Designed soil mix and a variety of plant material, including trees, shrubs, grasses, and/or other herbaceous plants within a vertical walled container usually constructed from formed concrete, but could include other materials. Bioretention planters have an open bottom that allows infiltration to the subgrade. These designs are often used in ultra-urban settings (see figure 6.1.2).

figure 6.1.1

Bioretention with primary design elements (under-drain is optional).
Source: AHBL

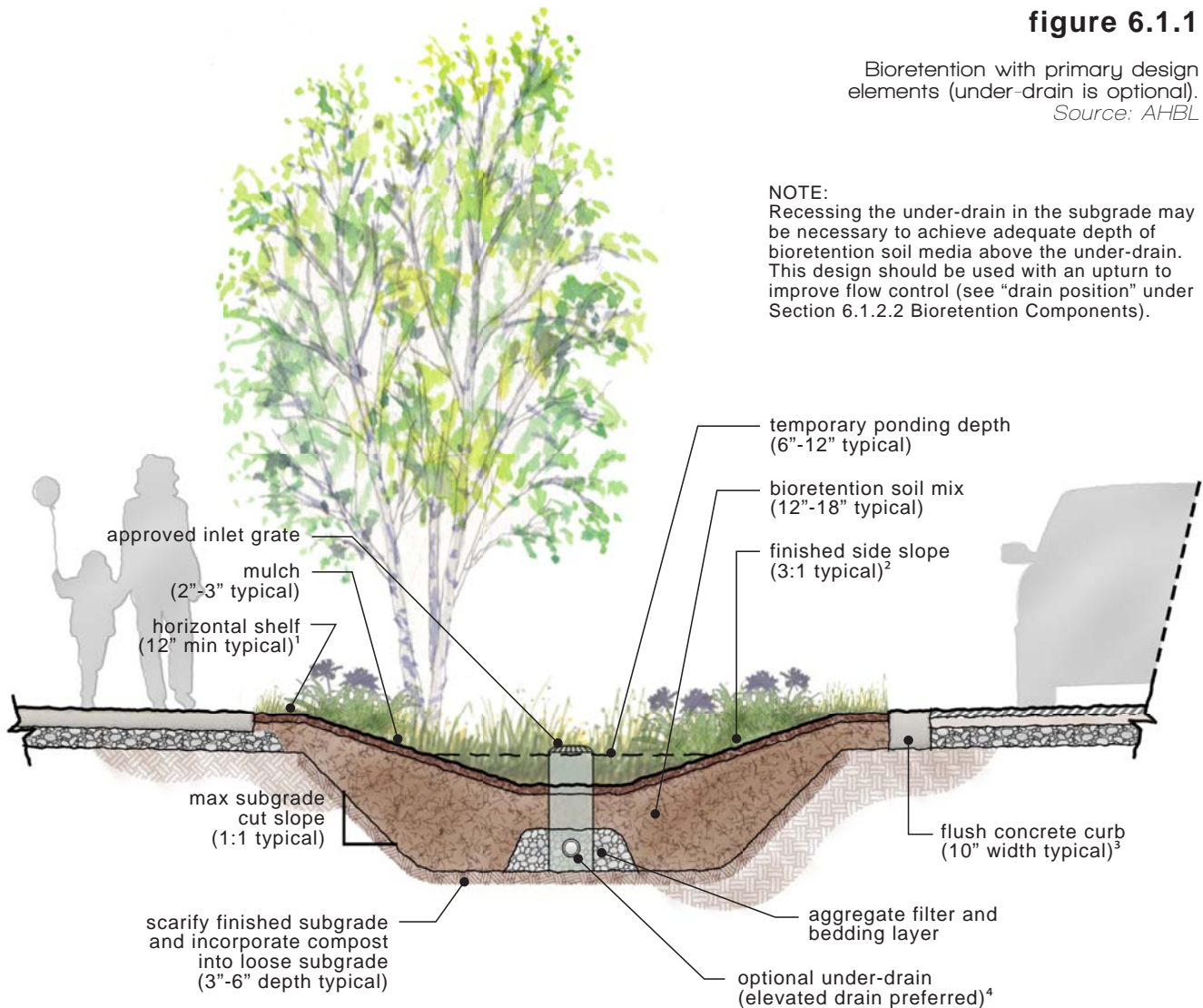

NOTE:
 Recessing the under-drain in the subgrade may be necessary to achieve adequate depth of bioretention soil media above the under-drain. This design should be used with an upturn to improve flow control (see "drain position" under Section 6.1.2.2 Bioretention Components).

GENERAL NOTES:

- Area and depth of facility are based upon engineering calculations and right-of-way constraints.
- Check dams may be required depending on slope and flow velocities.
- Bottom width should be a minimum of 2 feet to prevent channelization.

FOOTNOTES:

1. Horizontal shelf between sidewalk or road and bioretention area slope for safety.
2. Steeper side slopes may be necessary depending on setting and require additional attention for erosion control, plant selection vehicle and pedestrian safety, etc.
3. See Section 6.1.2.2 for additional curb designs.
4. Elevated drain provides benefits compared to an under-drain placed on bottom of facility including improved stormwater, retention, plant survival in drier months and nitrogen removal.

6

6.1 Bioretention

6.1.1 applications

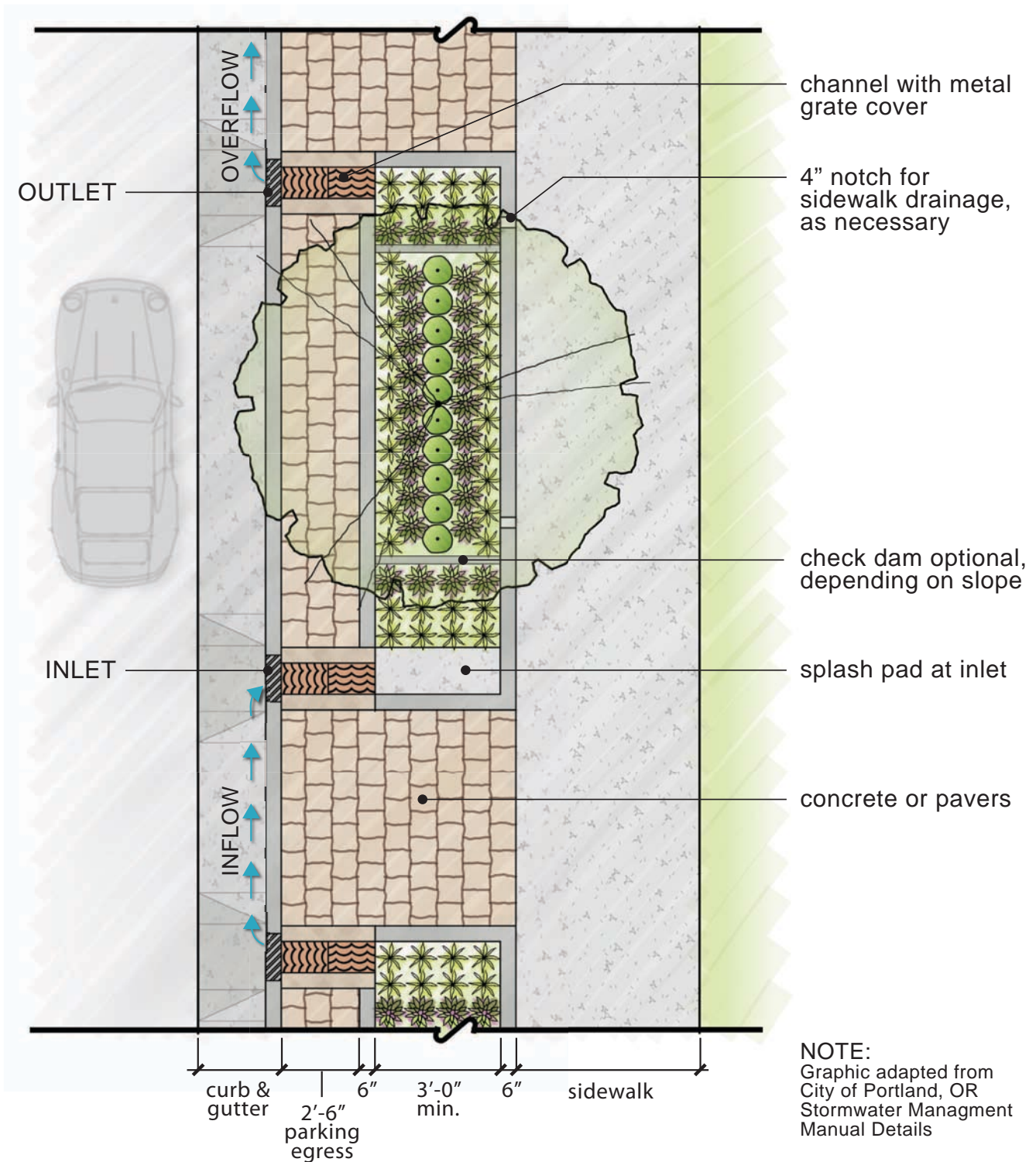

6.1 Bioretention

6.1.1 applications

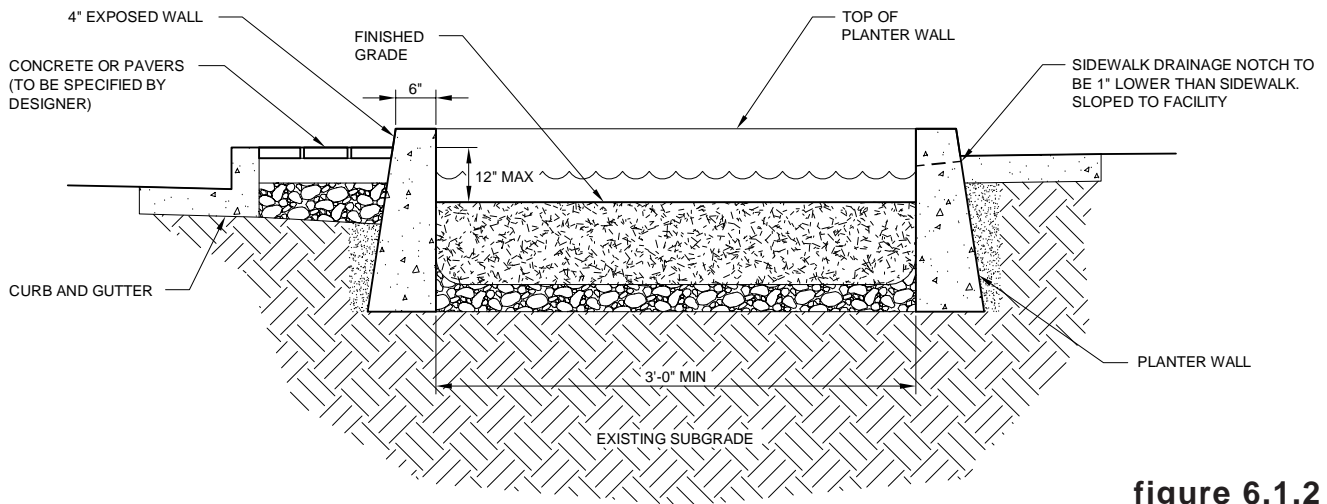

figure 6.1.2

Bioretention planter with primary design elements. Under-drains are optional for bioretention planters (open bottom) and required for bioretention planter boxes (closed impervious bottom).

Source: AHBL

- **Bioretention planter box:** Designed soil mix and a variety of plant material, including trees, shrubs, grasses, and/or other herbaceous plants within a vertical walled container usually constructed from formed concrete, but could include other materials. A bioretention planter box is completely impervious and includes a bottom and, accordingly, must include an under-drain and perhaps a control structure. These designs are often used in ultra-urban settings. To be considered an LID practice the planter box must have a volume reduction or flow control component to the design (see figure 6.1.2).

The following section outlines various applications and general design guidelines as well as specifications for individual bioretention components. This section draws information from numerous sources, including a growing body of international research; however, many of the specifications and guidelines are from extensive work and experience developed by the City of Seattle.

6.1.1 Applications

While original applications focused primarily on stormwater pollutant removal, bioretention can be highly effective for flow control as well. Where the surrounding native soils have adequate infiltration rates, bioretention can be used as a primary or supplemental retention system. Under-drain systems can be installed and the facility used to filter pollutants and detain flows that exceed infiltration capacity of the surrounding soil. However, an orifice or other control structure is necessary for designs with under-drains to provide significant flow control benefits.

Applications with or without under-drains vary extensively and can be applied in new development, redevelopment, and retrofits. Bioretention areas are most often designed as a multifunctional landscape amenity that provides water quality treatment, stormwater volume reduction, and flow attenuation. Typical applications include:

- Individual lots for managing rooftop, driveway, and other on-lot impervious surface.

6

6.1 Bioretention

6.1.1 applications

- Shared facilities located in common areas for individual lots.
- Areas within loop roads or cul-de-sacs.
- Landscaped parking lot islands. These facilities can also be used to meet landscape requirements.
- Within right-of-ways along roads (often linear bioretention swales and cells). These facilities are sometimes designed to have traffic-calming functions as well.
- Common landscaped areas in apartment complexes or other multifamily housing designs.
- Bioretention planters are often used in highly urban settings as stormwater management retrofits next to buildings or within streetscapes. Bioretention planters are generally not recommended for less dense settings where larger scale bioretention areas can be incorporated for increased flow control capability.

Examples of bioretention areas

Numerous designs have evolved from the original bioretention concept as designers have adapted the practice to different physical settings. See figures 6.1.3 through 6.1.7 for different types of (but are not limited to) bioretention designs.



figure 6.1.3

Rain garden on an individual lot.
Source: Rain Dog Designs

6.1 Bioretention 6

6.1.1 applications

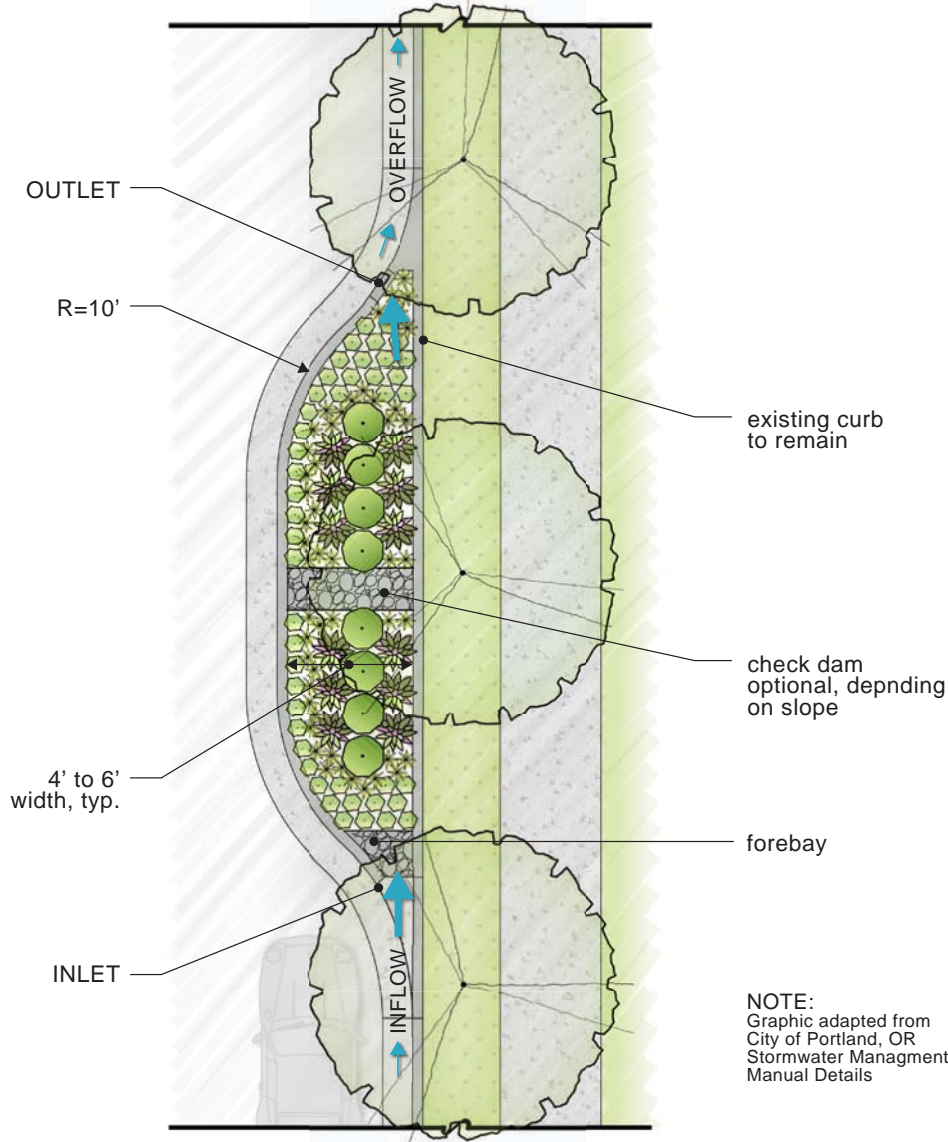

figure 6.1.4

Bioretention in parking lot islands or along roadways. These can be used with curb or curbless inlet designs. Source: Illustration by AHBL Photos by Curtis Hinman

NOTE:
Graphic adapted from
City of Portland, OR
Stormwater Management
Manual Details



6

6.1 Bioretention

6.1.1 applications



figure 6.1.5

Bioretention swales along roadway (low gradient).
Source: Seattle Public Utilities



figure 6.1.6

Bioretention swale along roadway (high gradient). Gradient controls, such as check dams, gravel mulch, and catch basins are used to reduce flow velocity and manage erosion and sediment transport.
Source: Curtis Hinman



Bioretention planters. **figure 6.1.7**
Source: Curtis Hinman

6.1.2 Design

Central design and site suitability considerations

Bioretention systems are placed in a variety of residential and commercial settings and are a visible and accessible component of the site. Design objectives and site context are, therefore, important factors for successful application. The central design considerations and site suitability criteria include:

- **Soils:** The bioretention soil media (BSM) and soils underlying and surrounding bioretention facilities are the principal design elements for determining infiltration capacity, sizing, and associated conveyance structures. The BSM placed in the cell or swale is typically composed of a highly permeable sandy mineral aggregate mixed with compost and will often have a higher infiltration rate than the surrounding subgrade; however, in some cases (such as outwash soils) the subgrade infiltration rate may be higher. See Section 6.1.2.2: Bioretention Components for details.
- **Site topography:** Based on geotechnical concerns, infiltration on slopes greater than 10 percent should only be considered with caution. The site assessment should clearly define any landslide and erosion critical areas and coastal bluffs, and appropriate setbacks required by the local jurisdiction. Thorough geotechnical analysis should be included when considering infiltration within or near slope setbacks. Depending on adjacent infrastructure (e.g., basements and subsurface utilities) and subgrade geology, geotechnical analysis may also be necessary on relatively low gradients. See below for slope setbacks.
- **Depth to hydraulic restriction layer:** Separation to a hydraulic restriction layer (rock, compacted soil layer or water table) is an important design consideration for infiltration and flow control performance. Protecting groundwater quality is a critical factor when infiltrating stormwater; however, when determining depth to the water table the primary concern for Ecology is infiltration capacity (as influenced by ground water mounding) and associated flow control performance. When properly designed and constructed, the BSM will provide very good water quality treatment before infiltrated stormwater reaches the subgrade and then groundwater (see Section 6.1.2.2: Bioretention components for recommended BSM depth and Section 6.1.2.5

6

6.1 Bioretention

6.1.2 design

for water quality treatment performance). The following are recommended minimum separations to groundwater:

- » A minimum separation of 1 foot from the hydraulic restriction layer to the bottom of the bioretention area is recommended where the contributing area has less than 5,000 square feet of pollution-generating impervious surface; and less than 10,000 square feet of impervious surface; and less than $\frac{3}{4}$ acre of lawn, landscape, and other pervious surface.
 - » A minimum separation of 3 feet from the hydraulic restriction layer to the bottom of the bioretention area is recommended where the contributing area is equal to or exceeds any of the following limitations: 5,000 square feet of pollution-generating impervious surface; or 10,000 square feet of impervious surface; or $\frac{3}{4}$ acre of lawn, landscape, and other pervious surface.
 - » Note that recommended separation distances for bioretention areas with small contributing areas are less than the Ecology recommendation of 3-5 feet for conventional infiltration facilities for two reasons: 1) bioretention soil media provides effective pollutant capture; and 2) hydrologic loading and potential for groundwater mounding is reduced when flows are directed to bioretention facilities from smaller contributing areas.
- **Utilities:** Consult local jurisdiction requirements for horizontal and vertical separations required for publically owned utilities, such as water, sewer, and stormwater pipes. Consult the appropriate franchise utility owners for separation requirements from their utilities, which may include communications and/or gas. See figure 6.1.8 for an example design detail illustrating vertical and horizontal separation requirements for roadway bioretention. Extensive **potholing** may be needed during project planning and design to develop a complete understanding of the type, location, and construction of all utilities that may be impacted by the project.
 - When applicable separation requirements cannot be met, designs should include appropriate mitigation measures, such as impermeable liners over the utility, sleeving utilities, fixing known leaky joints or cracked conduits, and/or adding an under-drain to the bioretention areas to minimize the amount of infiltrated stormwater that could enter the utility.
 - **Setbacks:** Consult local jurisdiction guidelines for appropriate bioretention area setbacks from wellheads, on-site sewage systems, basements, foundations, utilities, slopes, contaminated areas, and property lines. General recommendations for setbacks include:
 - » Within 50 feet from the top of slopes that are greater than 20 percent.
 - » Within 100 feet of an area known to have deep soil contamination.
 - » Within 100 feet of a closed or active landfill.
 - » Within 100 feet of a drinking water well or a spring used for drinking water supply.
 - » Within 10 feet of small on-site sewage disposal drain field (including reserve area) and grey water reuse systems. For setbacks from a “large onsite sewage disposal system”, see Chapter 246-272B WAC.
 - » Note: Setback distances are measured from the bottom edge of the bioretention soil mix, i.e., intersection of the bottom and side slope of the bioretention area.
 - **Expected pollutant loading and soil and effluent quality:** Bioretention can provide very good water quality treatment for residential, commercial, and industrial sites. For heavy pollutant loads associated with industrial settings, an impermeable liner between the BSM and the subgrade and an under-drain may be required due to soil and groundwater contamination concerns. Areas where infiltration is not recommended, or a liner and under-drain should be incorporated due to soil contamination concerns, include:
 - » For properties with known soil or groundwater contamination (typically federal Superfund sites or cleanup sites under the state Model Toxics Control Act (MTCA))

6.1 Bioretention 6

6.1.2 design

Recommended utility setbacks.
Source: AHBL and HDR

figure 6.1.8

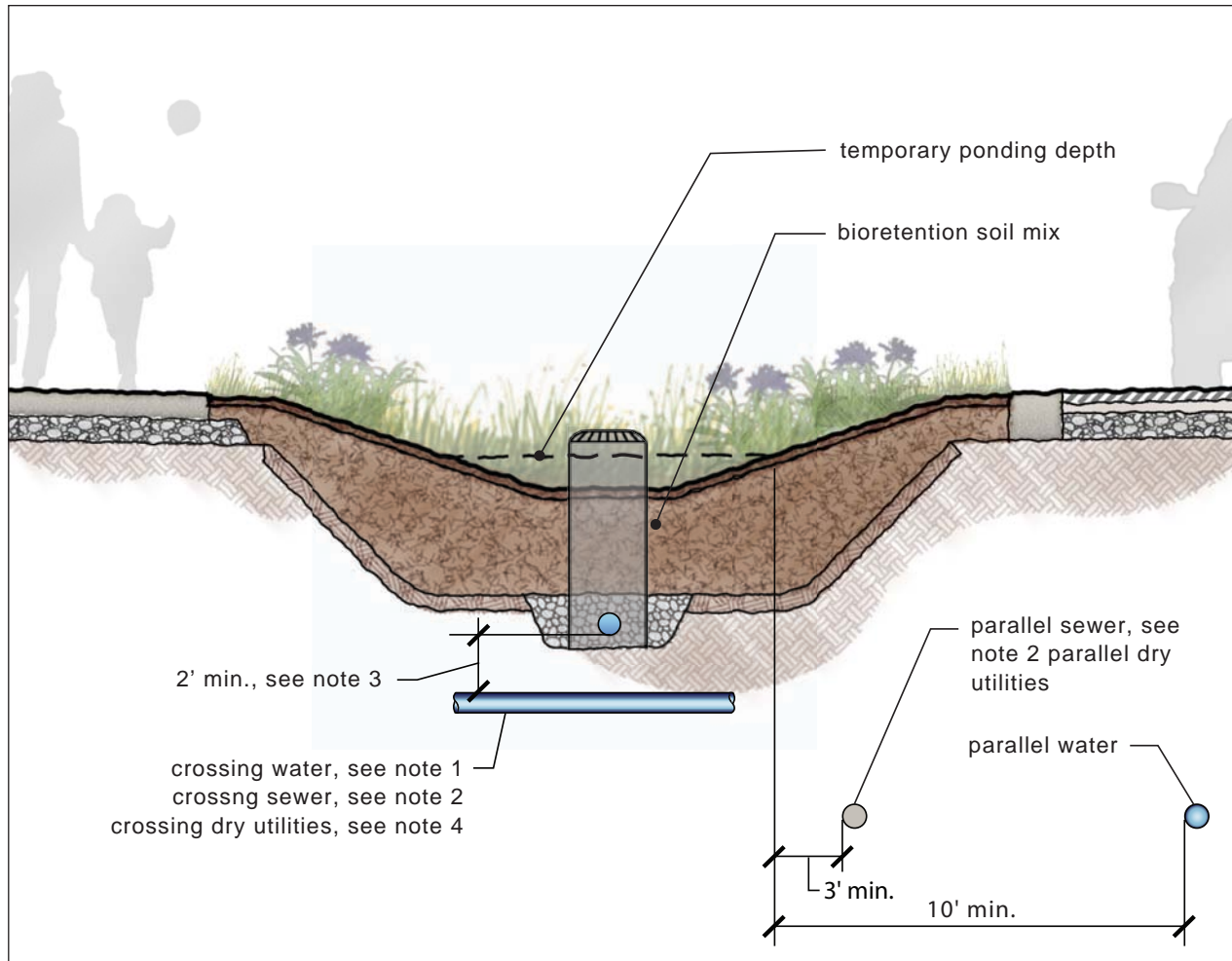

NOTES:

1. Line bioretention or sleeve water lines at crossing locations, if directed by engineer.
2. Line Bioretention where side sewer is above the bioretention facility, or use sealed sewer pipe where sewer pipes may be vulnerable to infiltration, if directed by engineer.
3. Use polyethylene foam pad or other approved materials when utility crossing separation standards cannot be achieved per local jurisdiction standards.
4. Dry utilities, such as power, gas, and communications, may be backfilled with non-infiltrating materials, such as controlled density fill or fluidized thermal backfill. Include appropriate measures in designs to protect these utilities and account for their possible effect on infiltration performance.
5. Sufficient potholing or other investigation techniques must be conducted to determine the location and construction of all utilities in the project corridor.
6. If infiltration into utility trenches is a concern, use trench dams or other means of preventing or limiting migration of infiltrated stormwater.

6

6.1 Bioretention

6.1.2 design

- » Where groundwater modeling indicates infiltration will likely increase or change the direction of the migration of pollutants in the groundwater.
- » Wherever surface soils have been found to be contaminated unless those soils are removed within 10 horizontal feet from the infiltration area.
- » Any area where these facilities are prohibited by an approved cleanup plan under MTCA or federal Superfund law, or an environmental covenant under Chapter 64.70 RCW.
- **Phosphorus (P) and nitrogen (N) considerations:** For bioretention systems with direct discharge to fresh or marine water, or located on soils adjacent to fresh or marine water that do not meet the soil suitability criteria in Chapter 3 of Volume III of the 2012 SWMMWW. See sections 6.1.2.2: Bioretention components and 6.1.2.5: Performance for recommended designs by pollutant type.
- **Transportation safety:** The design configuration and selected plant types should provide adequate sight distances, clear zones, and appropriate setbacks for roadway applications in accordance with the local jurisdiction requirements. Bioretention designs that extend the curb line into the roadway (e.g., chicanes and neck-downs) can provide traffic-calming functions and improve vehicle and pedestrian safety.
- **Ponding depth and surface water draw-down:** Plant and soil health, flow control needs, water quality treatment performance, location in the development, and mosquito breeding cycles will determine draw-down timing. For example, front yards and entrances to residential or commercial developments may require more rapid surface dewatering than necessary for plant and soil health due to aesthetic needs. See Section 6.1.2.2: Bioretention components for details.
- **Infiltration capability:** See Volume 3 section 3.4 of the 2012 SWMMWW for recommended minimum infiltration rate.
- **Impacts of surrounding activities:** Human activity influences the location of the facility in the development. For example, locate bioretention areas away from traveled areas on individual lots to prevent soil compaction and damage to vegetation, or provide elevated or bermed pathways in areas where foot traffic is inevitable (see Section 6.1.2.2: Bioretention components for details) and provide barriers, such as wheel stops, to restrict vehicle access in parking lot applications.
- **Visual buffering:** Bioretention areas can be used to buffer structures from roads, enhance privacy among residences, and for an aesthetic site feature.
- **Site growing characteristics and plant selection:** Appropriate plants should be selected for sun exposure, soil moisture, and adjacent plant communities. Native species or hardy cultivars are recommended and can flourish in the properly designed and placed BSM with no nutrient or pesticide inputs and 2-3 years irrigation for establishment. Manual invasive species control may be necessary. Pesticides or herbicides should never be applied in bioretention areas.
- **Maintenance:** see Section 6.1.2.4: Maintenance and Appendix 4 for details.

6.1.2.1 Determining subgrade and bioretention soil media design infiltration rates

Determining infiltration rates of the soils underlying the bioretention areas and the BSM is necessary for sizing facilities, routing, checking for compliance with the maximum drawdown time, and determining flow reduction and water quality treatment benefits when using the WWHM or MGS Flood. See figure 6.1.9 for a graphic representation of the process to determine infiltration rates.

This section describes methods for determining infiltration rates and design procedures specific to bioretention areas. For information on overall site assessment see Chapter 2: Site Assessment.

Note that for projects replacing or installing 2,000-5,000 ft² of new hard surface and triggering Minimum Requirement #5 in the 2012 SWMMWW and using a rain garden for stormwater control, guidance for design

and installation is available in this manual, the 2012 SWMMWW as well as the 2007 *Rain Garden Handbook for Western Washington Homeowners*.

Determining the flow control and water quality treatment benefits of bioretention areas without under-drains requires knowing:

- The short-term (initial/measured) saturated hydraulic conductivity (Ksat) of soils underlying the bioretention area.
- If and what correction factors are applied to determine the long-term (design) infiltration rate of the soils underlying the bioretention areas (see below for determining initial and design infiltration rates).
- The estimated long-term design BSM rate (short-term or initial Ksat with appropriate correction factor applied).

Determining the flow control and water quality treatment benefits of bioretention areas with under-drains requires knowing:

- The estimated long-term BSM rate (short-term or initial Ksat with appropriate correction factor applied).
- Orifice or control structure design.

See Chapter 7 for more detail on flow control modeling for bioretention areas.

1. Subgrade soils underlying the bioretention areas

A preliminary site assessment is necessary for designing LID projects with bioretention areas and other distributed stormwater management practices integrated into the project layout. Preliminary site assessment includes surface and subsurface feature characterizations to determine infiltration capability of the site, initial design infiltration rates, and potential bioretention area locations. For more information on initial site assessment, see Chapter 2: Site Assessment and Section 2.1: Soil and subsurface characterization.

The methods below are used to determine the short-term (initial) saturated hydraulic conductivity rate for subgrade (existing) soil profile beneath the bioretention areas. The initial or measured saturated hydraulic conductivity with no correction factor may be used as the design infiltration rate if the qualified professional engineer deems the infiltration testing described below (and perhaps additional tests) is conducted in locations and at adequate frequencies that produces a soil profile characterization that fully represents the infiltration capability where bioretention areas are located (e.g., if the small-scale PITs are performed for all bioretention areas and the site soils are adequately homogeneous).

If deemed necessary by a qualified professional engineer, a correction factor may be applied to the measured saturated hydraulic conductivity to determine the long-term (design) infiltration rate of the subgrade soil profile. Heterogeneity of the site soils and number of infiltration tests in relation to the number of bioretention areas will determine whether or not a correction factor is used as well as the specific number used (see below for more detail on correction factors). The overlying BSM provides excellent protection for the underlying native soil from sedimentation; accordingly, the underlying soil does not require a correction factor for influent control and clogging over time.

If a single bioretention facility serves a drainage area exceeding 1 acre, a groundwater mounding analysis should be done in accordance with Volume III, Section 3.3.5 of the 2012 *SWMMWW*.

The initial Ksat can be determined using:

- A. In-situ small-scale PIT; or
- B. A correlation to grain size distribution from soil samples, if the site has soils that are not consolidated by glacial advance. The latter method uses the ASTM soil size distribution test procedure (ASTM D422), which considers the full range of soil particle sizes, to develop soil size distribution curves.

6

6.1 Bioretention

6.1.2 design

See Section 2.1 Soil and subsurface characterization for test procedure details.

If feasible, small-scale PITs are recommended for each bioretention site. Long, narrow bioretention facilities, such as a bioretention swale following the road right-of-way, should have a test location at a maximum of every 200 feet and wherever soil characteristics are known to change. However, if the site subsurface characterization, including soil borings across the development site, indicates consistent soil characteristics and adequate depth to a hydraulic restriction layer, the number of test locations may be reduced. Observations through a wet season are necessary to identify a seasonal groundwater restriction.

Correction factors for subgrade soils underlying bioretention areas

The correction factor for in-situ, small-scale PITs is determined by the number of tests in relation to the number of bioretention areas and site variability. Correction factors range from 0.33 to 1 (no correction) and are determined by a licensed geotechnical engineer or licensed engineering geologist.

Tests should be located and be at adequate frequency capable of producing a soil profile characterization that fully represents the infiltration capability where the bioretention areas are located. If used, the correction factor depends on the level of uncertainty that variable subsurface conditions justify. If a PIT is conducted for all bioretention areas or the range of uncertainty is low (e.g., conditions are known to be uniform through previous exploration and site geological factors), one PIT may be adequate to justify no correction factor (see Table 6.1.1: Correction factors for in-situ K_{sat} measurements to estimate long-term or design infiltration rates of subgrade soils underlying bioretention).

If the level of uncertainty is high, a correction factor near the low end of the range may be appropriate. The following are two example scenarios where low correction factors may apply:

- Site conditions are highly variable due to a deposit of ancient landslide debris or buried stream channels. In these cases, even with many explorations and several pilot infiltration tests, the level of uncertainty may still be high.
- Conditions are variable, but few explorations and only one PIT is conducted (i.e., the number of explorations and tests conducted do not match the degree of site variability anticipated).

A correction factor for siltation and bio-buildup is not necessary for bioretention area subgrades. Correction factors are applied to the BSM to account for the influence of siltation (see section below for determining infiltration rates for the BSM).

table 6.1.1 Correction factors for in-situ K_{sat} measurements to estimate long-term or design infiltration rates of subgrade soils underlying bioretention.

Site Analysis Issue	Correction Factor
Site variability and number of locations tested	CF = 0.33 to 1
Degree of influent control to prevent siltation and bio-buildup	No correction factor required

2. Bioretention soil media

The following provides recommended tests and guidelines for determining infiltration rates of the bioretention soil media (BSM). If not using the BSM in Section 6.1.2.2 under Bioretention soil media, determine K_{sat} by ASTM D 2434 Standard Test Method for Permeability of Granular Soils (Constant Head) with a compaction rate of 85 percent using ASTM D1557 Test Method for Laboratory Compaction Characteristics of Soil Using Modified Effort. If using the BSM in Section 6.1.2.2 under Bioretention soil media, assume a K_{sat} of 6 inches per hour. See Section 6.1.2.2 for more detail on BSM infiltration rates and other properties. Depending on the size of contributing area, use one of the following two guidelines.

- A. If the contributing area of the bioretention cell or swale has less than 5,000 square feet of pollution-generating impervious surface; and less than 10,000 square feet of impervious surface; and less than $\frac{3}{4}$ acre of lawn, landscape, and other pervious surface:
 - Use 2 as the infiltration reduction (correction) factor.
- B. If the contributing area of the bioretention cell or swale is equal to or exceeds any of the following thresholds: 5,000 square feet of pollution-generating impervious surface; or 10,000 square feet of impervious surface; or $\frac{3}{4}$ acre of lawn, landscape, and other pervious surface:
 - Use 4 as the infiltration reduction (correction) factor.

Enter the subgrade and BSM infiltration rates in WWHM or MGS Flood to determine the flow reduction and water quality treatment benefits of the bioretention areas.

ASTM D 2434 Standard Test Method for Permeability of Granular Soils provides standardized guidelines for determining hydraulic conductivity of mineral aggregate (granular) soils. Bioretention soil mixes contain significant amounts of organic material and specific procedures within geotechnical labs can vary. Appendix 3: Laboratory Procedures for Determining Bioretention Soil Mix Saturated Hydraulic Conductivity

provides guidelines to standardize procedures and reduce inter-laboratory variability when testing BSM's with mineral and organic material content.

6

6.1 Bioretention

6.1.2 design

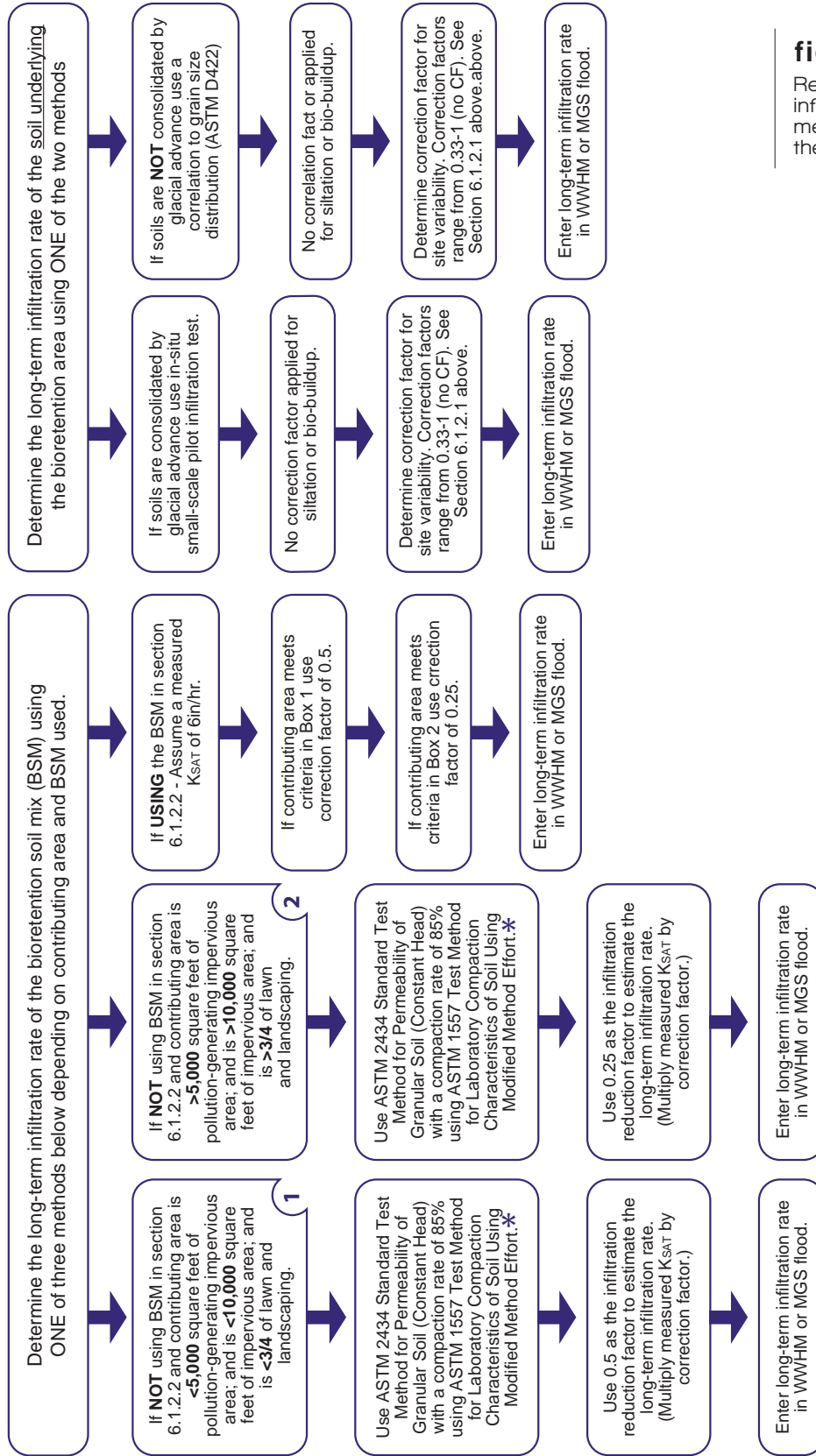

figure 6.1.9

Recommendations for determining infiltration rates of bioretention soil media and subgrade soils under the media.

* See guidelines in appendix 3 for using ASTM 2435 to test bioretention soil containing significant organic content.

6.1.2.2 Bioretention components

The following provides a description and suggested guidelines and specifications for the components of bioretention cells and swales. Some or all of the components may be used for a given application depending on the site characteristics and restrictions, pollutant loading, and design objectives.

Flow entrance

Flow entrance design will depend on topography, flow velocities, and volume entering the pretreatment and bioretention area, adjacent land use, and site constraints. Flows entering a rain garden should be less than 1.0 foot per second to minimize erosion potential. Five primary types of flow entrances can be used for bioretention cells:

- *Dispersed, low velocity flow across a landscape area:* Landscape areas and vegetated buffer strips slow incoming flows and provide an initial settling of particulates and are the preferred method of delivering flows to the bioretention cell. Dispersed flow may not be possible given space limitations or if the facility is controlling roadway or parking lot flows where curbs are mandatory.
- *Dispersed or sheet flow across pavement or gravel and past wheel stops for parking areas.*
- *Curb cuts for roadside, driveway or parking lot areas:* Curb cuts should include a rock pad, concrete, or other erosion protection material in the channel entrance to dissipate energy. Minimum curb cut width should be 12 inches; however, 18 inches is recommended. Avoid the use of angular rock or quarry spalls and instead use round (river) rock if needed. Removing sediment from angular rock is difficult. The flow entrance should drop 2-3 inches from curb line (see figures 6.1.10 and 6.1.11) and provide an area for settling and periodic removal of sediment and coarse material before flow dissipates to the remainder of the cell (Prince George's County, Maryland, 2002, and U.S. Army Environmental Center and Fort Lewis, 2003).
- Curb cuts used for bioretention areas in high use parking lots or roadways may require higher level

of maintenance due to increased accumulation of coarse particulates and trash in the flow entrance and associated bypass of flows. Recommended methods for areas where heavy trash and coarse particulates are anticipated:

- » Make curb cut width 18 inches.
- » At a minimum the flow entrance should drop 2-3 inches from gutter line into the bioretention area and provide an area with a concrete bottom for settling and periodic removal of debris.
- » Anticipate relatively more frequent inspection and maintenance for areas with large impervious areas, high traffic loads, and larger debris loads.
- » Catch basins or forebays may be necessary at the flow entrance to adequately capture debris and sediment load from large contributing areas and high use areas. Piped flow entrance in this setting can easily clog, and regular maintenance of catch basins is necessary to capture coarse and fine debris and sediment.
- *Piped flow entrance:* Piped entrances should include rock or other erosion protection material in the channel entrance to dissipate energy and disperse flow.
- *Trench drains:* Trench drains can be used to cross sidewalks or driveways where a deeper pipe conveyance creates elevation problems. Trench drains tend to clog and may require additional maintenance (see figure 6.1.12).

Woody plants can restrict or concentrate flows, be damaged by erosion around the root ball, and should not be placed directly in the entrance flow path.

Pre-settling

Forebays and pre-settling are recommended for concentrated flow entrances (curb-cuts, trench drains, and pipes) to reduce accumulation of sediment and trash in the bioretention area and maintenance effort. Open forebays or catch-basins can be used for pre-settling.

6

6.1 Bioretention

- Catch basins: In some locations where road sanding or higher than usual sediment inputs are anticipated, catch basins can be used to settle sediment and release water to the bioretention area through a grate for filtering coarse material (see figure 6.1.13).
- Open forebays (pre-settling areas specifically designed to capture and hold flows that first enter the bioretention area): The bottom of the pre-settling area should be large rock (2-4 inch streambed or round cobbles) or concrete pad with a porous berm or weir that ponds the water to a maximum depth of 12 inches.



figure 6.1.10

Curb cut inlet with drop to prevent clogging at flow entrance.

Source: Photo by Curtis Hinman
Detail courtesy of the Bureau of Environmental Services, City of Portland OR.

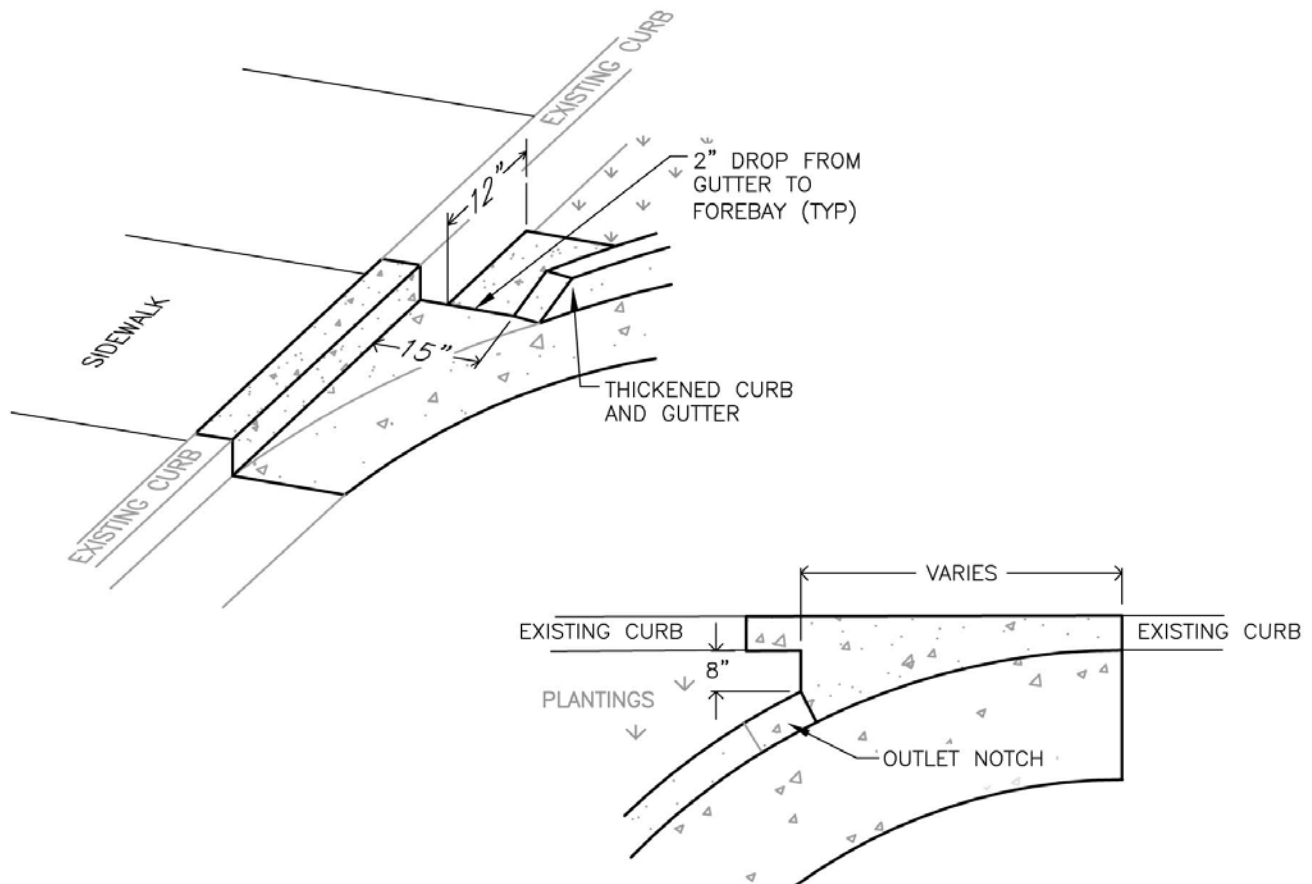

6.1 Bioretention

6.1.2 design



figure 6.1.11

Typical curb cut details
 Source: Photo by Curtis Hinman
 Detail from the Bureau of Environmental Services, City of Portland OR.

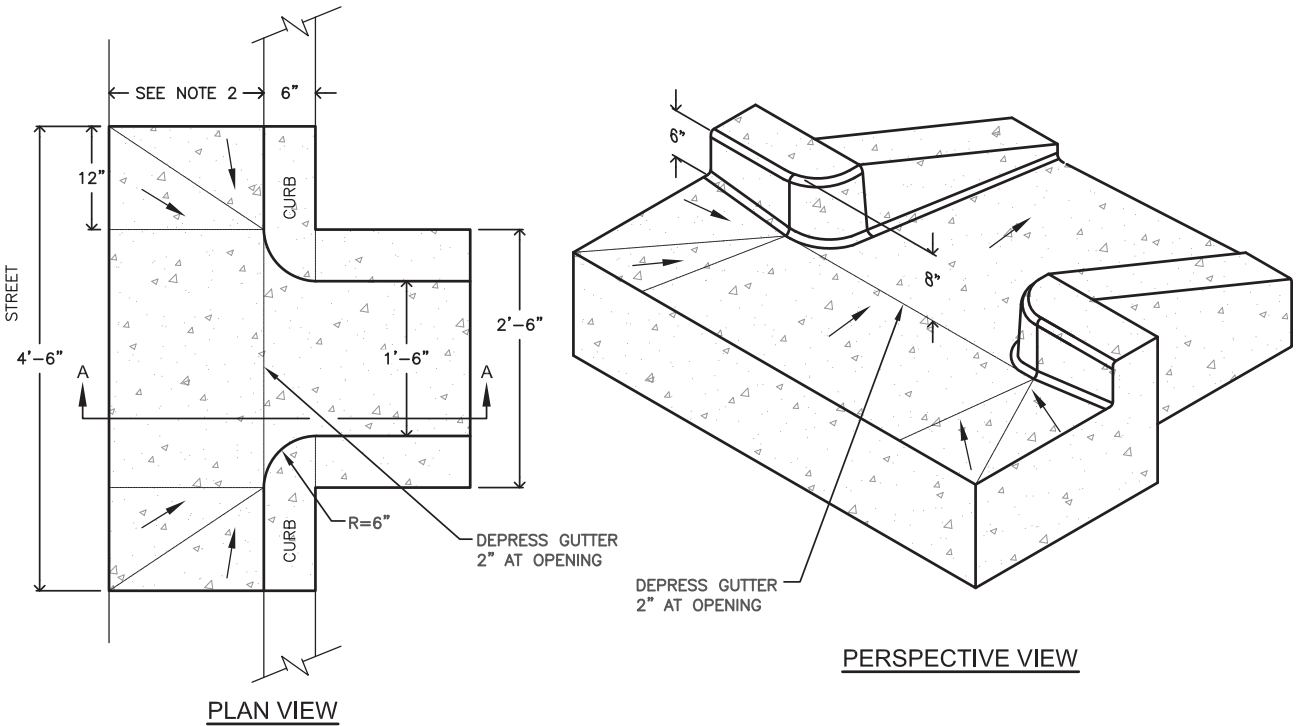

6

6.1 Bioretention

6.1.2 design

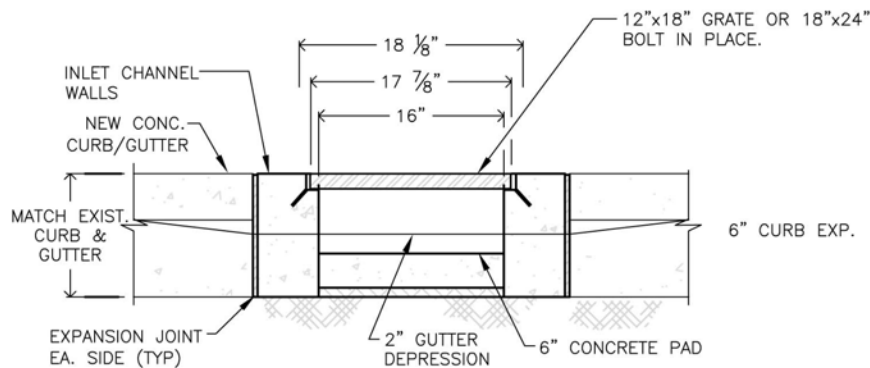
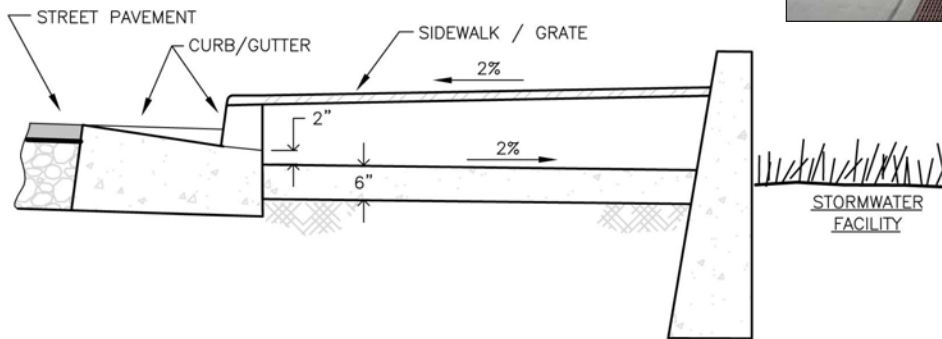
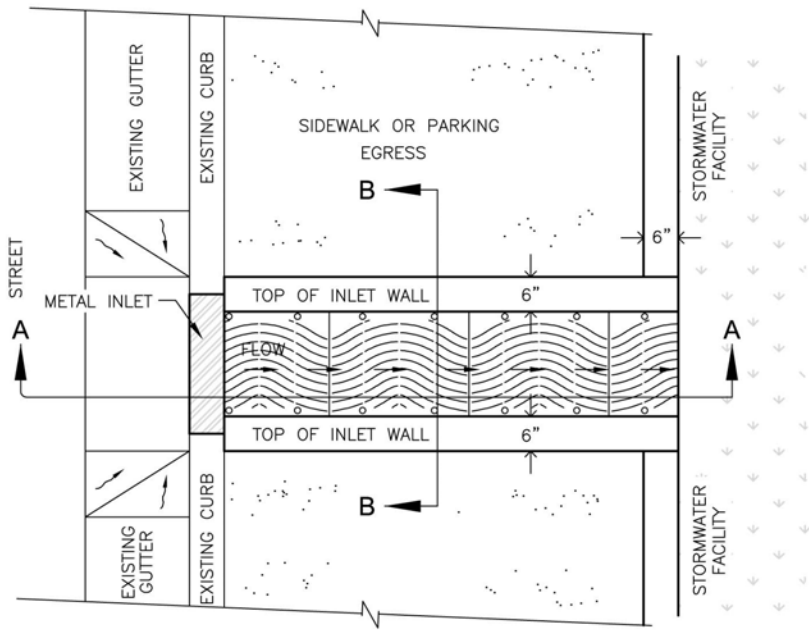

figure 6.1.12

Typical trench drain details
 Source: Photos by Curtis Hinman
 Details courtesy of the Bureau of
 Environmental Services, City of
 Portland OR.

figure 6.1.13

Catch basin inlet
Source: Curtis Hinman



Bottom area and side slopes

Bioretention areas are highly adaptable and can fit various settings, such as rural and urban roadsides, ultra urban streetscapes, and parking lots by adjusting bottom area and side slope configuration. Recommended maximum and minimum dimensions:

- Maximum planted side slope if total cell depth is greater than 3 feet: 3H:1V. If steeper side slopes are necessary, rockeries, concrete walls, or soil wraps may be effective design options (see figure 6.1.15). Local jurisdictions may require bike and/or pedestrian safety features, such as railings or curbs with curb cuts, when steep side slopes are adjacent to sidewalks, walkways, or bike lanes.
- Minimum bottom width for bioretention swales: 2 feet recommended and 1 foot minimum. Carefully consider flow depths and velocities, flow velocity control (check dams), and appropriate vegetation or rock mulch to prevent erosion and channelization at bottom widths less than 2 feet.

6

6.1 Bioretention

6.1.2 design

figure 6.1.15

Bioretention rocky wall detail

Source: AHBL

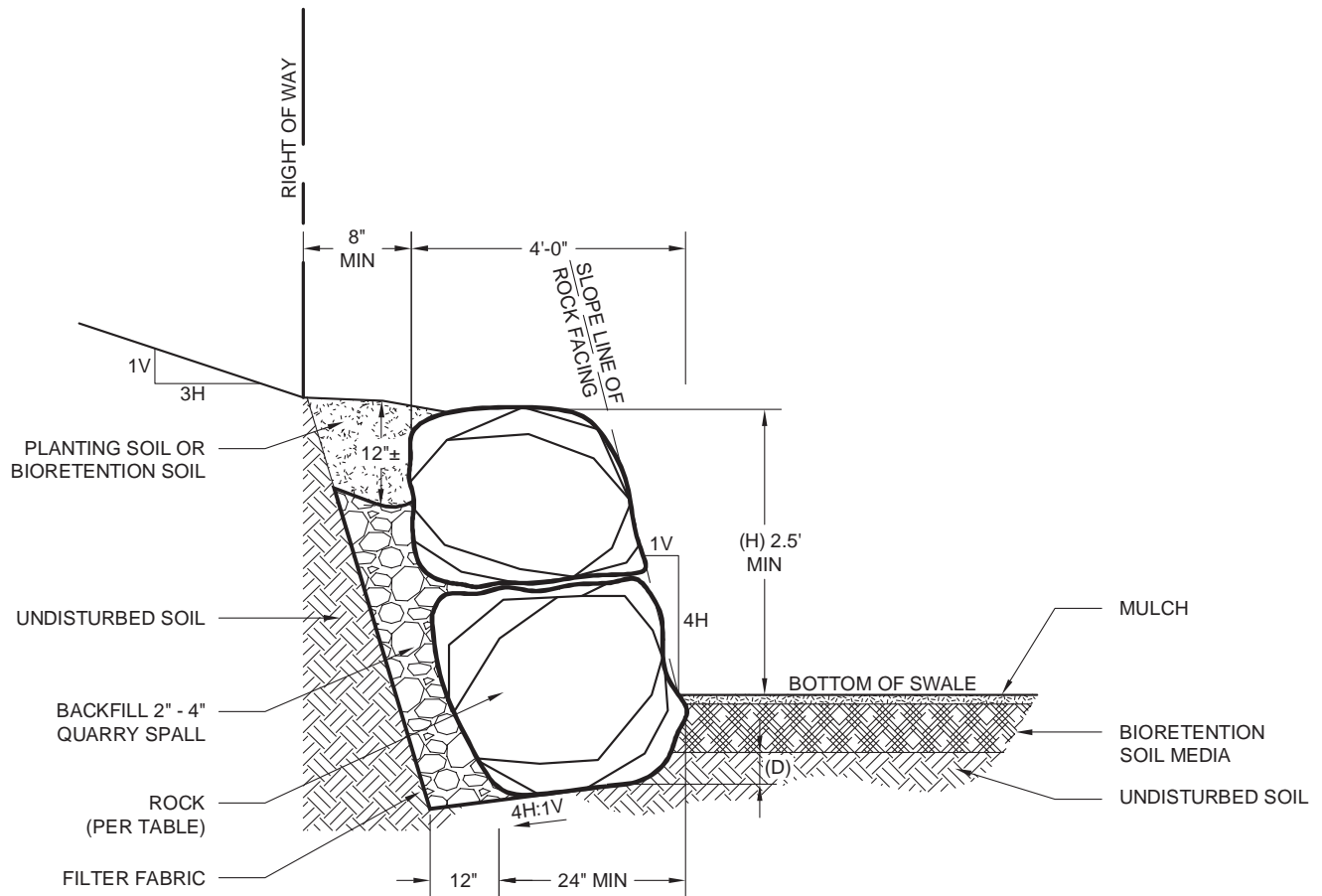

MINIMUM ROCK SIZES

(H)	SIZE(BASE)	SIZE(TOP)	(D)
2.5'	2-MAN	1-MAN	3"
4'	3-MAN	2-MAN	6"
7'	4-MAN	2-MAN	9"

NOTE:
GRAPHIC ADAPTED FROM CITY
OF SEATTLE, BROADVIEW
GREEN GRID PROJECT DETAIL



figure 6.1.16

Bioretention area with flush curb and shoulder
Source: Curtis Hinman

Bioretention areas should have a minimum shoulder of 12 inches between the road edge and beginning of the bioretention side slope where flush curbs are used. Compaction effort for the shoulder should be 90 percent standard proctor (see figure 6.1.16).

Ponding area

Ponding depth recommendations:

- Maximum ponding depth: 12 inches
- Maximum surface pool drawdown time: 24-48 hours

The ponding area provides surface storage for storm flows, particulate settling, and the first stages of pollutant treatment within the cell. Pool depth and draw-down rate are recommended to provide surface storage, adequate infiltration capability, and soil moisture conditions that allow for a range of appropriate plant species. Soils must be allowed to dry out periodically in order to: restore hydraulic capacity to receive flows from subsequent storms; maintain infiltration rates; maintain adequate soil oxygen levels for healthy soil biota and vegetation; and provide proper soil conditions for biodegradation and retention of pollutants.

Maximum surface pool drawdown time is also influenced by the location of the facility. For highly visible locations with denser populations, a 24-hour drawdown may be appropriate for community acceptance, while a 48-hour drawdown may be appropriate for less visible and dense settings.

Surface overflow

Surface overflow can be provided by vertical stand pipes that are connected to under-drain systems, horizontal drainage pipes, or armored overflow channels installed at the designed maximum ponding elevations (see figures 6.1.17). Overflow can also be provided by a curb cut at the down-gradient end of the bioretention area to direct overflows back to the street (see figure 6.1.1). Overflow conveyance structures are necessary for all bioretention facilities to safely convey flows that exceed the capacity of the facility and to protect downstream natural resources and property.

6

6.1 Bioretention

6.1.2 design

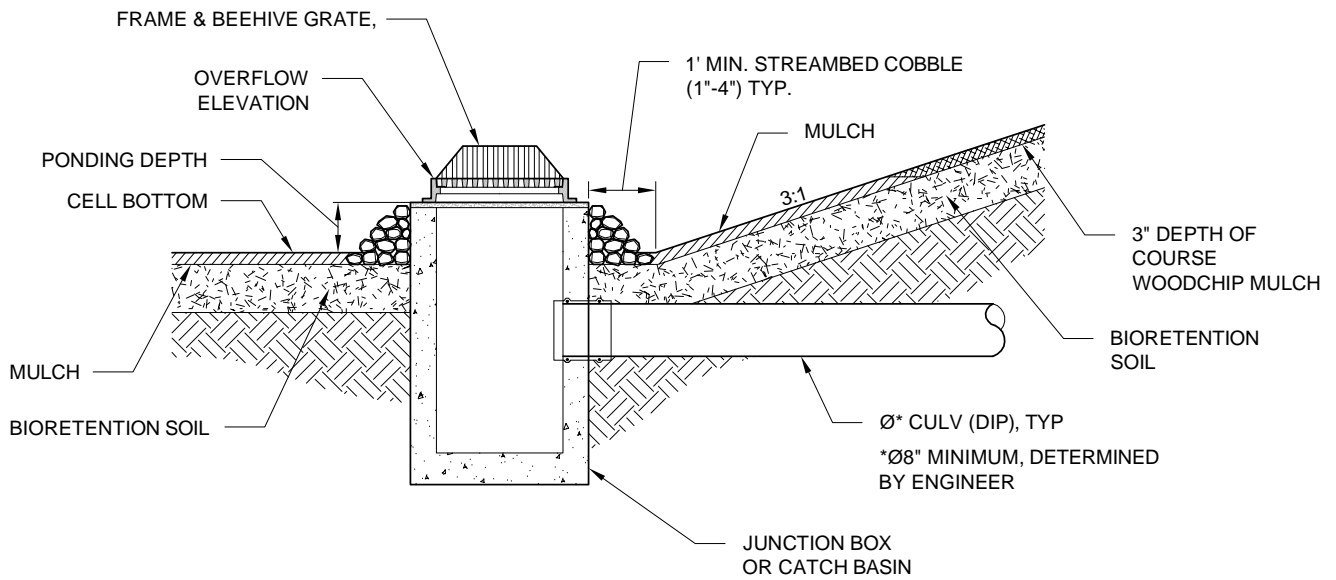

figure 6.1.17

Bioretention outlet structure providing elevation drop

Source:
Detail provided by AHBL
photo by Curtis Hinman



The minimum freeboard from the invert of the overflow stand pipe, horizontal drainage pipe, or earthen channel should be 6 inches unless otherwise specified by the local jurisdiction's design standards.

Bioretention soil media

The soil media and plants must work together to provide effective flow control and water quality treatment in bioretention areas. Soil mixes for bioretention areas need to balance four primary design objectives to provide optimum performance:

- Provide high enough infiltration rates to meet desired surface water drawdown and system dewatering.
- Provide infiltration rates that are not too high in order to optimize pollutant removal capability.
- Provide a growth media that supports long-term plant and soil health.
- Balance nutrient availability and retention to reduce or eliminate nutrient export during storm events (Hinman, 2009).

Bioretention soil media recommendations often have a topsoil component that generally does not have a grain size distribution specification and is highly variable depending on the source. As a result, the BSM can have higher than desired fines which may result in lower than desired infiltration rates.

The percent fines (aggregate passing the 200 sieve) in a BSM is important for proper system performance and requires particular attention. Presence of some fine material improves water retention, nutrient exchange and, as a result, the growing characteristics of soils. Smaller aggregate also increases receptor sites for adsorbing pollutants. In contrast, fine material strongly controls hydraulic conductivity and a small increase as a percentage of total aggregate can reduce hydraulic conductivity below rates needed for proper system draw-down (Hinman, 2009).

Overall gradation is important for BSM performance as well. The soil mix will likely infiltrate too rapidly if the aggregate component is a uniform particle size. Specifically, a uniformly graded, fine-grained material will have relatively low hydraulic conductivity (K). A uniformly graded, coarse-grained material will have a relatively high K (Robertson, 2009). However, a well-graded material that appears coarse-grained (BSM sand) can have relatively lower K in ranges suitable for BSM used without control structures.

The following provides guidelines for Ecology-approved BSM. *If the BSM is verified to meet the mineral aggregate gradation and compost guidelines below then no laboratory infiltration testing is required. If a different aggregate gradation and compost guideline is used, laboratory infiltration tests (ASTM methods given below) are required to verify that the BSM will meet infiltration requirements.*

Infiltration rates

- When using the approved BSM guidelines provided below, enter a Ksat of 6 inches per hour with appropriate correction factor in WWHM or MGS Flood.
- If using a different BSM guideline, laboratory Ksat testing is required. The Ksat determination should be no less than 1 inch per hour after a correction factor of 2 or 4 is applied (see Section 6.1.2.1 Determining subgrade and bioretention soil media design infiltration rates) and a maximum of 12 inches per hour with no correction factors applied. Enter the laboratory-determined Ksat with appropriate correction factor in WWHM or MGS Flood.

Mineral aggregate

Percent fines

- A range of 2-4 percent passing the 200 sieve is ideal and fines should not be above 5 percent for a proper functioning specification according to ASTM D422.

6

6.1 Bioretention

6.1.2 design

Aggregate gradation

The aggregate portion of the BSM should be well-graded. According to ASTM D 2487-98 (Classification of Soils for Engineering Purposes (Unified Soil Classification System)), well-graded sand for BSM should have the following gradation coefficients:

- Coefficient of Uniformity ($C_u = D_{60}/D_{10}$) equal to or greater than 4; and
- Coefficient of Curve ($C_c = (D_{30})^2/D_{60} \times D_{10}$) greater than or equal to 1 and less than or equal to 3.

Table 6.1.3 provides a gradation guideline for the mineral aggregate component of a BSM specification in western Washington (Hinman, Robertson, 2009). The sand gradation below is often provided by vendors as a well-graded utility or screened sand. With compost, this blend provides enough fines for adequate water retention, hydraulic conductivity within the recommended range (see below), pollutant removal capability, and plant growth characteristics for meeting design guidelines and objectives.

table 6.1.3 Guideline for BSM mineral aggregate gradation

Sieve Size	Percent Passing
3/8"	100
#4	95-100
#10	75-90
#40	25-40
#100	4-10
#200	2-5

Existing soils

- Where existing soils meet the above aggregate gradation, those soils may be amended rather than importing mineral aggregate.
- For small projects only subject to Minimum Requirements 1-5 in the *SWMMWW*, the native soil may be amended according to guidance in the Rain Garden Handbook for Western Washington Homeowners to build rain gardens.

BSM recommendations with a topsoil component (e.g., sandy loam) contain some percentage of organic matter. When topsoil is a component of a BSM, 30-35 percent compost is typically used to attain a desired percent organic matter by weight. The BSM guideline for western Washington uses sand only, which has very little or no organic material. Accordingly, the volumetric ratio to attain 4-8 percent organic material is 35-40 percent compost and 60-65 percent screened or utility sand. Soil components must be uniformly mixed.

“A quick way to determine the approximate organic matter content of a soil mix:

- **Compost is typically 40-50 percent organic matter (use 40 percent as an average).**
- **A mix that is 40 percent compost measured by volume is roughly 16% organic matter by volume.**
- **Compost is only 50 percent as dense as the soil, so the mix is approximately 8 percent organic matter by weight (the organic matter content in soil is determined by weighing the organic material before combustion and then weighing the ash post-combustion).”**

Compost

- Compost to aggregate ratio: 60-65 percent mineral aggregate, 35-40 percent compost.
- Organic matter content: 5-8 percent by weight.

Compost is the other primary component of a BSM. Compost qualities often determine the success or failure of bioretention soil media, in terms of infiltration and plant growth.

For compost standards to amend construction site soils, see Section 6.2: Amending Construction Site Soils for details.

To ensure that the BSM will support healthy plant growth and root development, contribute to biofiltration of pollutants, and not restrict infiltration when used in proportions typical of bioretention media, the following compost standards are required:

- Meets the definition of “composted materials” in WAC 173-350, Section 220 (including contaminant levels and other standards), available online at <http://www.ecy.wa.gov/programs/swfa/rules/rule350.html>.
- The compost product must originate a minimum of 65 percent by volume from recycled plant waste as defined in WAC 173-350-100 as “Type I Feedstocks.” A maximum of 35 percent by volume of other approved organic waste as defined in WAC 173-350-100 as “Type III”, including postconsumer food waste, but not including biosolids, may be substituted for recycled plant waste. Type II and IV feedstocks shall not be used for the compost going into bioretention facilities or rain gardens.
- Produced at a composting facility permitted by Ecology. A current list of permitted facilities is available at: <http://www.ecy.wa.gov/programs/swfa/solidwastedata/>.
- Stable (low oxygen use and CO₂ generation) and mature (capable of supporting plant growth) by tests shown below. This is critical to plant success in BSM.
- Moisture content range: no visible free water or dust produced when handling the material.
- Tested in accordance with the U.S. Composting

Council “Testing Methods for the Examination of Compost and Composting” (TMECC), as established in the Composting Council’s “Seal of Testing Assurance” (STA) program. Most Washington compost facilities now use these tests.

- Screened to the size gradations for Fine Compost under TMECC test method 02.02-B.
- pH between 6.0 and 8.5 (TMECC 04.11-A). If the pH falls outside of the acceptable range, it may be modified with lime to increase the pH or iron sulfate plus sulfur to lower the pH. The lime or iron sulfate must be mixed uniformly into the soil prior to use in bioretention area (Low Impact Development Center, 2004).
- Manufactured inert content less than 1 percent by weight (TMECC 03.08-A).
- Organic matter content of 40-65 percent.
- Soluble salt content less than 4.0 mmhos/cm (TMECC 04.10-A).
- Maturity greater than 80 percent (TMECC 05.05-A “Germination and Vigor”).
- Stability of 7 or below (TMECC 05.08-B “Carbon Dioxide Evolution Rate”).
- Carbon to nitrogen ratio (TMECC 04.01 “Total Carbon” and 04.02D “Total Kjeldahl Nitrogen”) of less than 25:1. The C:N ratio may be up to 35:1 for plantings composed entirely of Puget Sound Lowland native species and up to 40:1 for coarse compost to be used as a surface mulch (not in a soil mix).

More information on using compost, compost benefits, a list of soil laboratories, and more can be found in Building Soil: Guidelines and Resources for Implementing WDOE Soil Quality and Depth BMP T5.13 in the 2012 SWMMWW available online at www.soilsforsalmon.org or www.buildingsoil.org.

6

6.1 Bioretention

6.1.2 design

Cation exchange capacity

- Cation Exchange Capacity (CEC) must be \geq 5 milliequivalents/100 g dry soil (S-10.10 from Gavlak et. al. 2003).

CEC is a measure of how many positively charged elements or cations (e.g., magnesium (Mg+2), calcium (Ca+2), and potassium (K+1)) soil can retain. Clay and organic material are the primary soil constituents providing receptor sites for cations and to a large degree determine CEC. One of the parameters for determining site suitability for stormwater infiltration treatment systems is CEC. Site Suitability Criteria #6 in the 2012 SWMMWW requires that soil CEC must be \geq 5 milliequivalents/100 g dry soil (Ecology, 2012). Bioretention soil mixes easily meet and exceed the Site Suitability Criteria #6 requirement.

BSM depth

- Typical BSM depth is 12-24 inches.
- For enhanced treatment and using the BSM guidelines in this manual as an Ecology-approved media, depth must be a minimum of 18 inches.
- A minimum depth of 24 inches should be selected for improved phosphorus and nitrogen (TKN and ammonia) removal where under-drains are used.

Deeper BSM profiles (> 24 inches) may enhance phosphorus, TKN and ammonia removal (Davis, Shokouhian, Sharma and Minami, 1998). Nitrate removal in bioretention cells can be poor and in some cases cells can generate nitrate due to nitrification (Kim et al., 2003). See under-drain section for design recommendations to enhance nitrate removal. Deeper or shallower profiles may be desirable for specific plant, soil, and storm flow management objectives.

Infiltration rates and water quality treatment considerations

Bioretention soil media provide the necessary characteristics for infiltration facilities intended to serve a treatment function. To meet Ecology's current criteria for infiltration treatment (SSC-6 "Soil Physical and Chemical Suitability for Treatment"), the maximum initial infiltration rate should not exceed 12 inches per

hour; the soil depth should be at least 18 inches; the CEC at least 5 meq/100 grams of soil, and the soil organic content at least 1.0 percent.

Bioretention soil media have high organic matter content and cation exchange capacities exceeding the above CEC criteria. Additionally, recent water quality treatment research for bioretention soils suggests that capture of metals remains very good at higher infiltration rates. Nitrate and ortho-phosphate retention and removal is likely influenced by plants, organic matter, and soil structure as well as soil oxygen levels, soil water content, and hydraulic residence time. Infiltration rate is, therefore, one of several factors that likely play an important role for nitrate and phosphate management in bioretention systems. More research is needed examining the influence of these various factors and to develop defensible infiltration rate guidelines for nutrient management. See below for nutrient management guidelines given current research and Section 6.1.2.5: Performance for more detail on bioretention flow control and water quality treatment.

Phosphorus management recommendations

These recommendations are applicable to any bioretention installation, but are critical for bioretention areas that have under-drains and direct release to fresh water or eventually drain to water bodies with TDMLs for nutrients or are specifically designated as phosphorus (P) sensitive by the local jurisdiction. Levels of P in bioretention areas are generally not a concern with groundwater unless there is groundwater transport of P through soils with low P sorption capability and close proximity to surface freshwater. Note that additional research is needed on P management in bioretention; however, current research indicates the following:

- Mature stable compost: reduces leaching of bio-available P.
- Healthy plant community: provides direct P uptake, but more importantly promotes establishment of healthy soil microbial community likely capable of rapid P uptake.
- Aerobic conditions: reduce the reversal of P

sorption and precipitation reactions.

- Increasing BSM column depth: to 24 or 36 inches may provide greater contact time with aluminum, iron, and calcium components, and sorption in the soil.
- Relatively neutral pH: for western Washington, the BSM pH should be between 5.5 and 7.0, which is an acceptable range to minimize reversal of P sorption reactions and allow for sorption and precipitation using aluminum hydroxide.
- Metal oxides: iron, aluminum, and calcium are metals that can be added to adsorb or precipitate P. Aluminum is the most applicable for bioretention systems with appropriate adsorption reaction time, relative stability, and pH range for reaction (Lucas, 2009). Water treatment residuals (WTRs), used for settling suspended material in drinking water intakes, is a waste product and source for aluminum and iron hydroxides. More research is needed in this area, but current trials indicate that WTRs can be added at a rate of 10 percent by volume to the BSM for sorption of P. WTRs are fine textured and, if incorporated into the BSM, laboratory analysis is required to verify appropriate hydraulic conductivity (see Section 6.2.1: Determining subgrade and bioretention soil media design infiltration rates). If using WTRs at a rate of 10 percent by volume, add shredded bark at 15 percent by volume to compensate for the fine texture of the WTRs (e.g., 60 percent sand, 15 percent compost, 15 percent shredded bark, 10 percent WTRs).
- Available P: the molar ratio of ammonia oxalate extracted P in relation to ammonia oxalate extracted Fe and Al in the BSM should be < 0.25 .
- Sandy gravel filter bed for under-drain: provides a good filter for fine particulates and additional binding sites for P (see below for more details on under-drains).

Nitrogen management recommendations

These recommendations are applicable to any bioretention installation, but are critical for bioretention areas that have under-drains and direct release to marine water. Nitrogen (N) levels in bioretention areas

are generally not a concern with groundwater unless there is groundwater transport of N in close proximity to marine water. Note that additional research is needed on N management in bioretention; however, current research indicates the following:

- Mature stable compost: Reduces leaching of bio-available nitrate (NO₃-N).
- Healthy plant community: Provides direct NO₃-N uptake, but more importantly promotes establishment of healthy soil microbial community likely capable of rapid NO₃-N uptake.
- Increasing BSM column depth: to 24 or 36 inches may provide greater contact time with small anoxic pockets within the soil structure and denitrification in the soil column.
- Elevated under-drain: Research suggests that N capture and retention in bioretention areas varies from good retention to export of nitrate. Where nitrate is a concern, various under-drain designs can be used to create a fluctuating anoxic/aerobic zone below the drain pipe (see figure 6.1.19). Denitrification within the anaerobic zone is facilitated by microbes using forms of N (NO₂ and NO₃) instead of oxygen for respiration. A suitable carbon source provides a nutrition source for the microbes, enables anaerobic respiration, and can enhance the denitrification process (Kim, Seagren and Davis, 2003). Dissolved and particulate organic carbon that migrates from the BSM to the aggregate filter and bedding layer likely provides adequate carbon source for microbes.

Biosolids and manure composts can be higher in bio-available P and N than compost derived from yard or plant waste. Accordingly, biosolids or manure compost in bioretention areas are not recommended in order to reduce the possibility of exporting bio-available P and N in effluent.

6

6.1 Bioretention

6.1.2 design

table 6.1.4 Guideline for bioretention soil media.

Component	Parameter	Method	Acceptable Range	Required Test	Recommended Test	
Aggregate	Aggregate Gradation	ASTM D 422	Sieve Size	Percent	X	
			3/8 inch	100		
			No. 4	95 - 100		
			No.10	75 - 90		
			No. 40	25 - 40		
			No. 100	4-10		
			No. 200	2 - 5		
	Coefficient of uniformity	ASTM D 422	≥ 4		X	
Compost	pH	TMECC 04.11-A	6.0 – 8.5	X		
	Carbon nitrogen ratio	TOC – TMECC 04.01 TKN – TMECC 04.02D	25 carbon: 1 nitrogen. Up to 35:1 when using plants composed entirely of Puget Sound natives.	X		
	Inert material	TMECC 03.08-A	≤ 1%	X		
	Organic content	ASTM D 2974 or TMECC 05.07A	40-65% by dry weight	X		
	Restrict large pieces of compost	TMECC 02.02-B	100% passing 1" sieve	X		
	Feed stock composition	N/A	Feed stock ≤ 35% Type III stock Feed stock ≥ 65% Type I stock (WAC 173-350-100) Compost vendor must be certified by the US Composting Council STA Program	X		
	Maturity indicator	TMECC 05.05-A	> 80%	X		
	Stability indicator	TMECC 05.08-B	≤ 7	X		

6.1 Bioretention 6

6.1.2 design

Component	Parameter	Method	Acceptable Range	Required Test	Recommended Test
	Copper content	EPA 6020	<750 mg/kg	X	
	Zinc content	EPA 6020	<1400 mg/kg	X	
	Soluble salt	TMECC 04.10-A	<4 mmhos/cm	X	
Bioretention Soil Mix	Mix ratio (aggregate : compost)	N/A	60% mineral aggregate :40% compost	X	
	Permeability rate	ASTM D 2434	Initial rate less than 12 inches per hour at 85% compaction (ASTM D 1557). Long term (corrected initial rate) no less than 1 inch per hour. If using specification herein, assume an initial infiltration rate of 6 inches per hour.	Required if using a BSM other than specified herein.	X
	Organic matter content	ASTM D 2974 or TMECC 05.07A	4-8% (by dry weight)	Required if using a BSM other than specified herein.	X
	Ratio of Oxalate phosphorus and oxalate iron and aluminum	SSSA Mono.9 6-2.3	< 0.25 (> 0.25 indicates potential for phosphorus leaching)		X
	Cation exchange capacity	EPA 9081	≥5 meq/100 g dry soil	Required if using a BSM other than specified herein.	

6

6.1 Bioretention

6.1.2 design

Under-drain (optional)

The area above an under-drain pipe in a bioretention area provides detention and pollutant filtering; however, only the area below the under-drain invert and above the bottom of the bioretention facility (subgrade) can be used in the WWHM or MGS Flood for flow control benefit (see Chapter 7 for bioretention area flow control credits). Under-drain systems should only be installed when the bioretention area is:

- Located near sensitive infrastructure (e.g., unsealed basements) and potential for flooding is likely.
- Used for filtering storm flows from gas stations or other pollutant hotspots (requires impermeable liner).
- Areas with contaminated groundwater and soils.
- In soils with infiltration rates below the minimum rate allowed by the local jurisdiction or that are not adequate to meet maximum pool and soil column drawdown time.
- In an area that does not provide the minimum depth to a hydraulic restriction layer.

The under-drain can be connected to a downstream open conveyance (such as a bioretention swale), to another bioretention cell as part of a connected treatment system, day-lighted to a dispersion area using an effective flow dispersion practice, or to a storm drain.

Under-drain pipe

Under-drains should be slotted, thick-walled plastic pipe. The slot opening should be smaller than the smallest aggregate gradation for the gravel filter bed (see under-drain filter bed below) to prevent migration of material into the drain and clogging. This configuration also allows for pressurized water cleaning and root cutting if necessary. Under-drain pipe recommendation:

- Minimum pipe diameter: 4 inches (pipe diameter will depend on hydraulic capacity required, 4-8 inches is common).
- Slotted subsurface drain PVC per ASTM D1785 SCH 40.

- Slots should be cut perpendicular to the long axis of the pipe and be 0.04-0.069 inch by 1 inch long and be spaced 0.25 inch apart (spaced longitudinally). Slots should be arranged in two rows spaced on 45-degree centers and cover ½ of the circumference of the pipe.
- The under-drain can be installed with slots oriented on top or on bottom of pipe.
- Under-drains should be sloped at a minimum of 0.5 percent unless otherwise specified by an engineer.

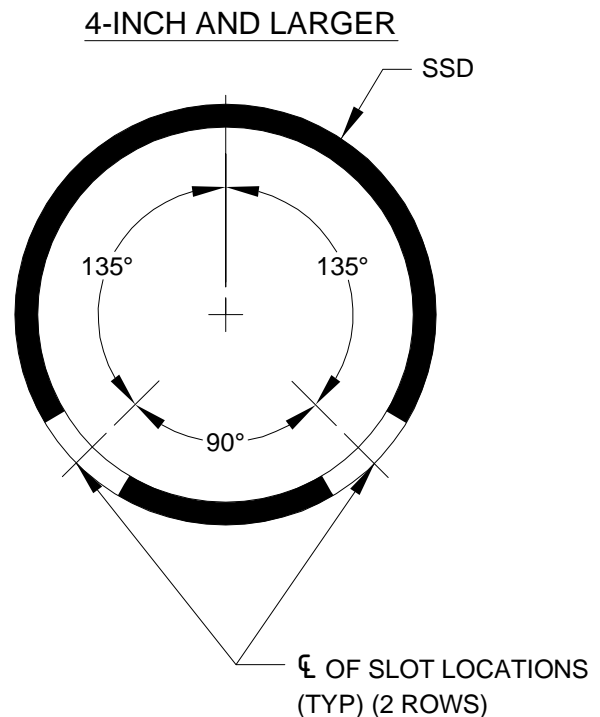

NOTE:
TYPICAL SLOT SIZE FOR
TYPE 26 AGGREGATE
FILTER & BEDDING LAYER
IS 0.04"

figure 6.1.18

Slotted under-drain detail (slots can be oriented up or down).
Source: City of Seattle Public Utilities

Perforated PVC or flexible slotted HDPE pipe cannot be cleaned with pressurized water or root cutting equipment, are less durable, and are not recommended. Wrapping the under-drain pipe in filter fabric increases chances of clogging and is not recommended (Low Impact Development Center, 2004). A 6-inch rigid non-perforated observation pipe or other maintenance access should be connected to the under-drain every 250-300 feet to provide a clean-out port as well as an observation well to monitor dewatering rates (Prince George's County, 2002 and personal communication, Tracy Tackett, 2004).

Under-drain aggregate filter and bedding layer

Aggregate filter and bedding layers and filter fabrics buffer the under-drain system from sediment input and clogging. When properly selected for the soil gradation, geosynthetic filter fabrics can provide adequate protection from the migration of fines. However, aggregate filter and bedding layers, with proper gradations, provide a larger filter surface area for protecting under-drains and are preferred (see table 6.1.5).

The below gradation is a Type 26 mineral aggregate (gravel backfill for drains, City of Seattle).

- Place under-drain on a bed of the Type 26 aggregate with a minimum thickness of 6 inches and cover with Type 26 aggregate to provide a 1-foot minimum depth around the top and sides of the slotted pipe.

table 6.1.5 Under-drain aggregate filter and bedding layer gradation.

Sieve Size	Percent Passing
3/4"	100
1/4"	30-60
US No. 8	20-50
US No. 50	3-12
US No. 200	0-1

Drain position

For bioretention areas with under-drains, elevating the drain to create a temporary saturated zone beneath the drain promotes denitrification (conversion of nitrate to nitrogen gas) and prolongs moist soil conditions for plant survival during dry periods (see figure 6.1.19).

Under-drains rapidly convey water out of the bioretention area and decrease detention time and flow retention. Properly designed and installed bioretention have shown very good flow control performance on soils with low infiltration rates (Hinman, 2009). Accordingly, when under-drains are used, orifices or other control structures are recommended to improve flow control. Access for adding or adjusting orifice configurations and other control structures is also recommended for adaptive management and optimum performance.

Orifice and other flow control structures

- The minimum orifice diameter should be 0.5 inch to minimize clogging and maintenance requirements.

6

6.1 Bioretention

6.1.2 design

figure 6.1.19

Upturned under-drain to create a saturated zone for denitrification

Source: AHB

Section - Length

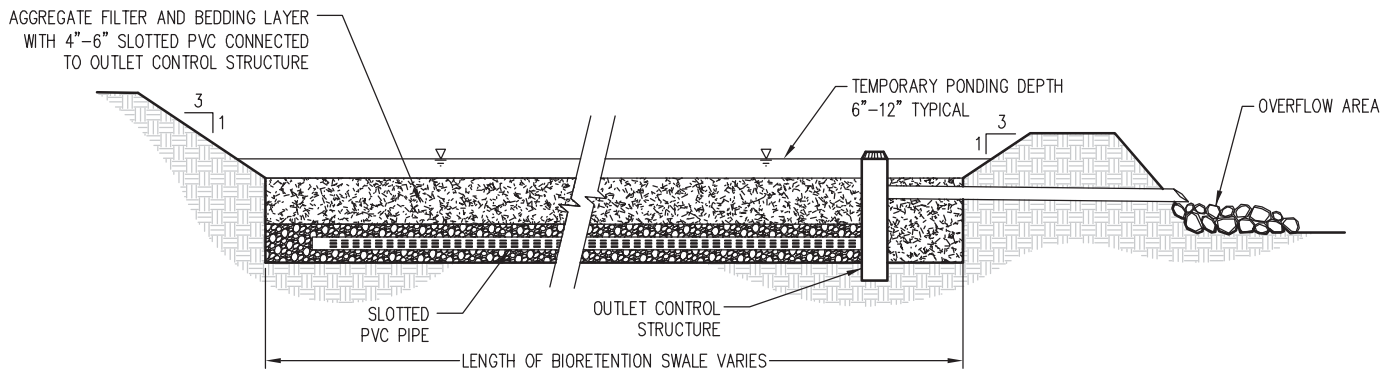

Section - Width

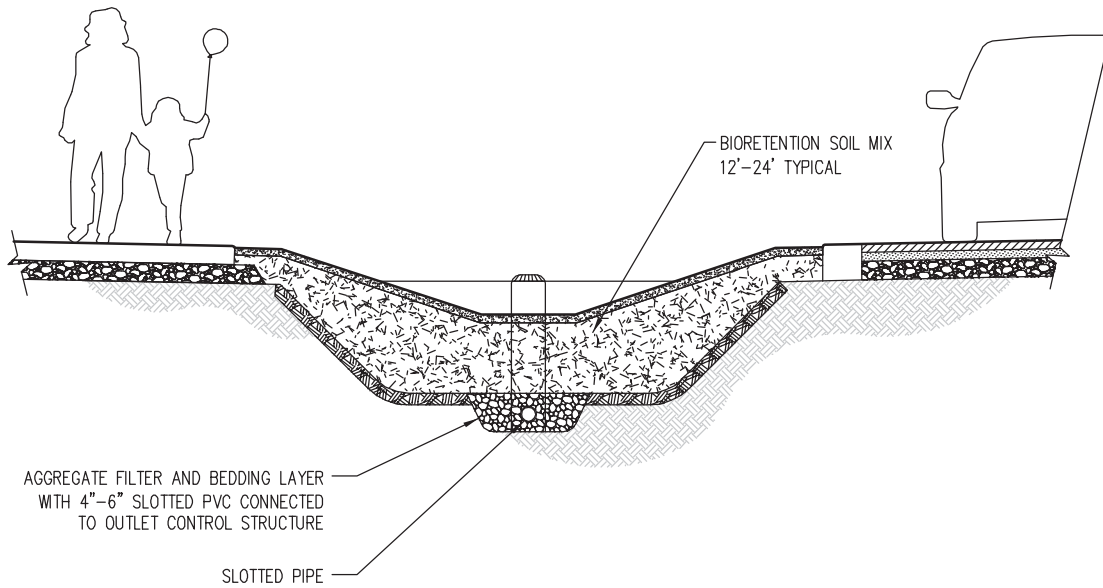

Check dams and weirs

Check dams are necessary for reducing flow velocity and potential erosion as well as increasing detention time and infiltration capability on sloped sites. Typical materials include concrete, wood, rock, compacted dense soil covered with vegetation, and vegetated hedge rows. Design depends on flow control goals, local regulations for structures within road right-of-ways, and aesthetics. Optimum spacing is determined by flow control benefit (through modeling) in relation to cost considerations. Some typical check dam designs are included in figure 6.1.20.

figure 6.1.20

Check dam and berms.
 Source: detail by AHBL
 Photos by Curtis Hinman

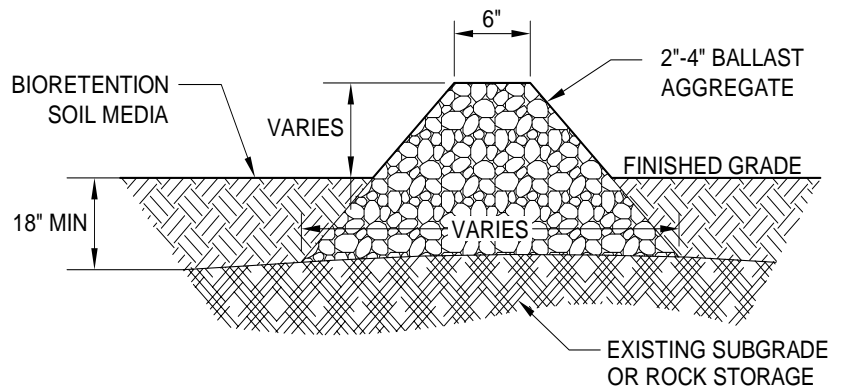

6

6.1 Bioretention

6.1.2 design

Hydraulic restriction layers

Adjacent roads, foundations or other infrastructure may require that infiltration pathways are restricted to prevent excessive hydrologic loading. Two types of restricting layers can be incorporated into bioretention designs:

- Clay (bentonite) liners are low permeability liners. Where clay liners are used, under-drain systems are necessary. See the 2012 SWMMWW Volume V, Section 4.4.3 for guidelines.
- Geomembrane liners completely block infiltration to subgrade soils and are used for groundwater protection when bioretention facilities are installed to filter storm flows from pollutant hotspots or on sidewalls of bioretention areas to restrict lateral flows to roadbeds or other sensitive infrastructure. (See figure 6.1.21) Where geomembrane liners are used to line the entire facility, under-drain systems are necessary. The liner should have a minimum thickness of 30 mils and be ultraviolet (UV) resistant.

Plants

Plant roots aid in the physical and chemical bonding of soil particles that is necessary to form stable aggregates, improve soil structure, and increase infiltration capacity. During the wet months in the Pacific Northwest (November through March), interception and evaporation are the predominant above-ground mechanisms for attenuating precipitation in native forest settings. Transpiration during the non-growing wet months is minimal (see Chapter 1: Introduction for details). In a typical bioretention cell, transpiration is negligible in the context of stormwater management unless the cell has a dense planting of trees, the stand is relatively mature (10-20 years), and the canopy structure is closing and varied. The relatively mature and dense canopy structure is necessary for adequate interception and advective evaporation in winter months. The primary and significant benefits of small trees, shrubs, and ground cover in bioretention areas during the wet season are the root structures, root exudates and contribution of organic matter that aids in the development of soil structure and infiltration capacity. See Appendix 1 for a bioretention plant table describing plant characteristics and optimum location within the bioretention area.

figure 6.1.21

Bioretention planter section with liner.
Source: AHBL, adapted from the
Bureau of Environmental Services,
City of Portland, details.

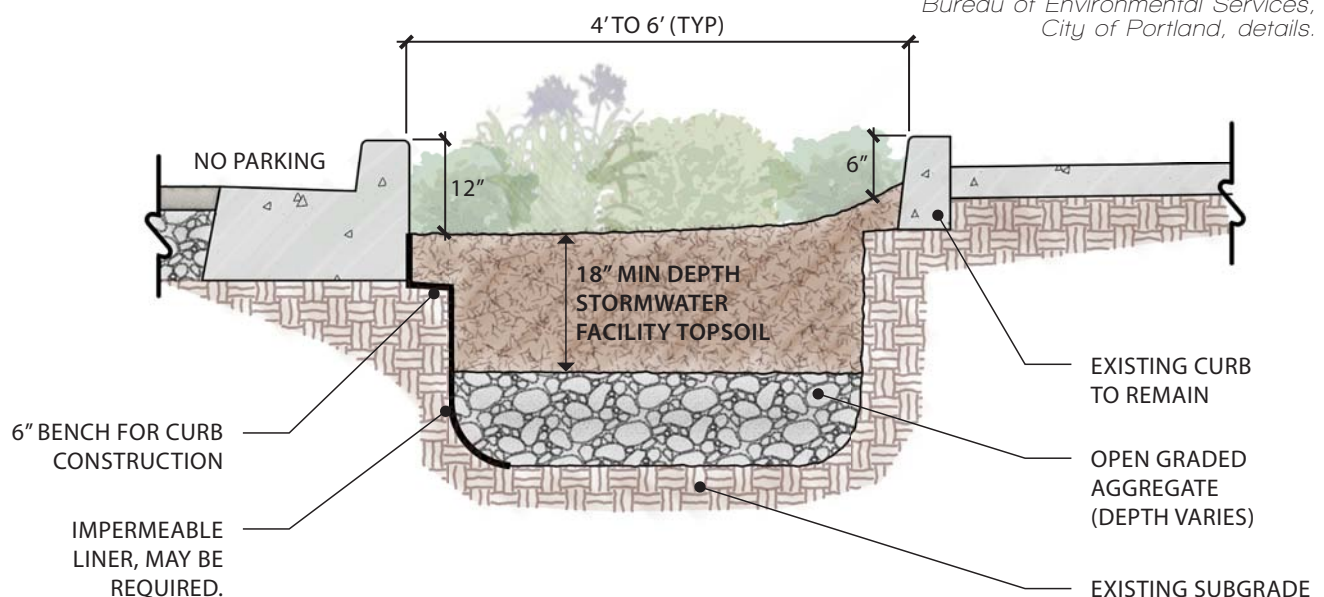

The primary design considerations for plant selection include:

- Soil moisture conditions: Plants should be tolerant of summer drought, ponding fluctuations, and saturated soil conditions for the lengths of time anticipated by the facility design.
 - Sun exposure: Existing sun exposure and anticipated exposure when bioretention plants mature is a primary plant selection consideration.
 - Above and below ground infrastructure in and near the facility: Plant size and wind firmness should be considered within the context of the surrounding infrastructure. Rooting depths should be selected to not damage underground utilities if present. Slotted or perforated pipe should be more than 5 feet from tree locations (if space allows).
 - Expected pollutant loadings: Plants should tolerate typical pollutants and loadings from the surrounding land uses.
 - Adjacent plant communities and potential invasive species control: Consider planting hearty, fast growing species when adjacent to invasive species and anticipate maintenance needs to prevent loss of plants to encroachment of invasive species.
 - Habitat: Native plants and hardy cultivars attract various insects and birds, and plant palettes can be selected to encourage specific species.
 - Site distances and setbacks for safety on roadway applications.
 - Location of infrastructure: Select plants and planting plan to allow visual inspection and easy location of facility infrastructure (inlets, overflow structures and other utilities).
 - Expected use: In higher density settings where foot traffic across bioretention areas is anticipated, elevated pathways with appropriate vegetation or other pervious material that can tolerate pedestrian use can be used (see figure 6.1.22). Pipes through elevated berms for pathways across bioretention areas can be used to allow flows from one cell to another.
- Visual buffering: Plants can be used to buffer structures from roads, enhance privacy among residences, and provide an aesthetic amenity for the site.
 - Aesthetics: Visually pleasing plant designs add value to the property and encourage community and homeowner acceptance. Homeowner education and participation in plant selection and design for residential projects should be encouraged to promote greater involvement in long-term care.

Note that the BSM provides an excellent growth media and plants will often attain or surpass maximum growth dimensions. Accordingly, planting layouts should consider maximum dimensions for selected plants when assessing site distances and adjacent uses.

In general, the predominant plant material utilized in bioretention areas are facultative species adapted to stresses associated with wet and dry conditions (Prince George's County, 2002). Soil moisture conditions will vary within the facility from saturated (bottom of cell) to relatively dry (rim of cell). Accordingly, wetland plants may be used in the lower areas, if saturated soil conditions exist for appropriate periods, and drought-tolerant species planted on the perimeter of the facility or on mounded areas (see figure 6.1.24). See Appendix 1 for recommended plant species.

Planting schemes will vary with the surrounding landscape and design objectives. For example, plant themes can reflect surrounding wooded or prairie areas. Monoculture planting designs are not recommended. As a general guideline, a minimum of three small trees, three shrubs, and three herbaceous groundcover species should be incorporated to protect against facility failure due to disease and insect infestations of a single species (Prince George's County, 2002). See figure 6.1.24 for a sample planting plan.

Native and hardy cultivar plant species, placed appropriately, tolerate local climate and biological stresses and usually require no nutrient or pesticide application in properly designed soil mixes. Natives can be used as the exclusive material in a rain garden

6

6.1 Bioretention

6.1.2 design



figure 6.1.22

Bioretention swales with elevated foot path and vegetation tolerant of foot traffic.

Source: photo by Curtis Hinman

or in combination with hardy cultivars that are not invasive and do not require chemical inputs. In native landscapes, plants are often found in associations that grow together well, given specific moisture, sun, soil, and plant chemical interactions. Native plant associations can, in part, help guide planting placement. To increase survival rates and ensure quality of plant material, the following guidelines are suggested:

- Plants should conform to the standards of the current edition of American Standard for Nursery Stock as approved by the American Standards Institute, Inc. All plant grades shall be those established in the current edition of American Standards for Nursery Stock (Low Impact Development Center, 2012).
- All plant materials shall have normal, well developed branches and a vigorous root system. Plants shall be healthy and free from physical defects, plant diseases, and insect pests. Shade and flowering trees shall be symmetrically balanced. Major branches shall not have V-shaped crotches capable of causing structural weakness. Trunks shall be free of unhealed branch removal wounds greater than a 1-inch diameter (Low Impact Development Center, 2012).
- Plant size: For installation, small plant material provides several advantages and is recommended. Specifically, small plant material requires less careful handling, less initial irrigation, experiences less transplant shock, is less expensive, adapts more quickly to a site, and transplants more successfully than larger material (Sound Native Plants, 2000). Typically, small herbaceous material and grasses are supplied as plugs or 4-inch pots and small trees and shrubs are generally supplied in pots of 3 gallons or less.
- Plant maturity and placement: Bioretention areas provide excellent soil and growing conditions; accordingly, plants will likely reach maximum height and width. Planting plans should anticipate these dimensions for site distances, adjacent infrastructure, and planting densities. Shrubs should be located taking into account size at maturity to prevent excessive shading and ensure establishment and vigor of bioretention area bottom plants.

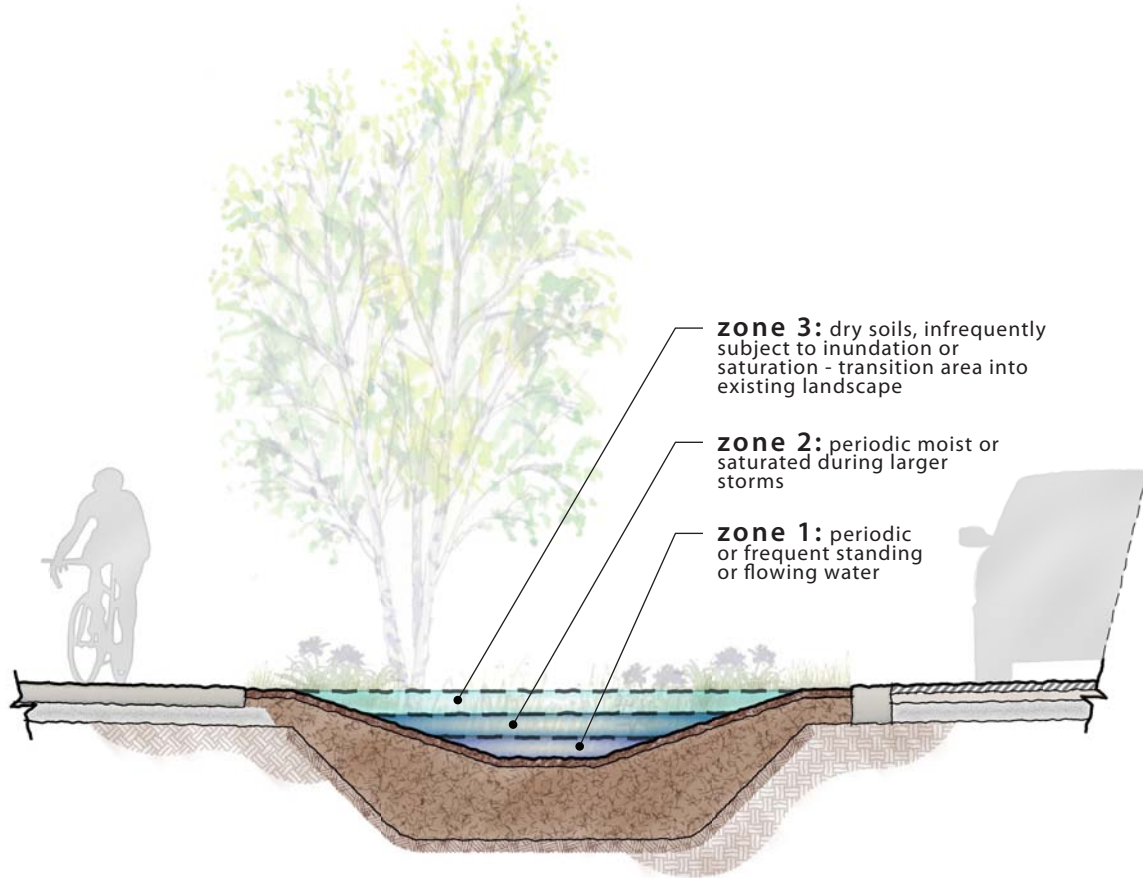

figure 6.1.23 Soil moisture zones in bioretention.
Source: AHBL

- All plants should be tagged for identification when delivered.
- Optimum planting time is Fall (beginning early October). Winter planting is acceptable; however, extended freezing temperatures shortly after installation can increase plant mortality. Spring is also acceptable, but requires more summer watering than fall plantings. Summer planting is the least desirable and requires regular watering for the dry months immediately following installation.

Mulch layer

Bioretention areas can be designed with or without a mulch layer; however, there are advantages to providing a mulch application. Properly selected mulch material reduces weed establishment (particularly during plant establishment period), regulates soil temperatures and moisture, and adds organic matter to soil. When used, mulch should be:

- Arborist wood chips consisting of shredded or chipped hardwood or softwood trimmings from trees and shrubs. Wood chip operations are also a good source for mulch material and provide good control of size distribution and consistency.

6

6.1 Bioretention

6.1.2 design

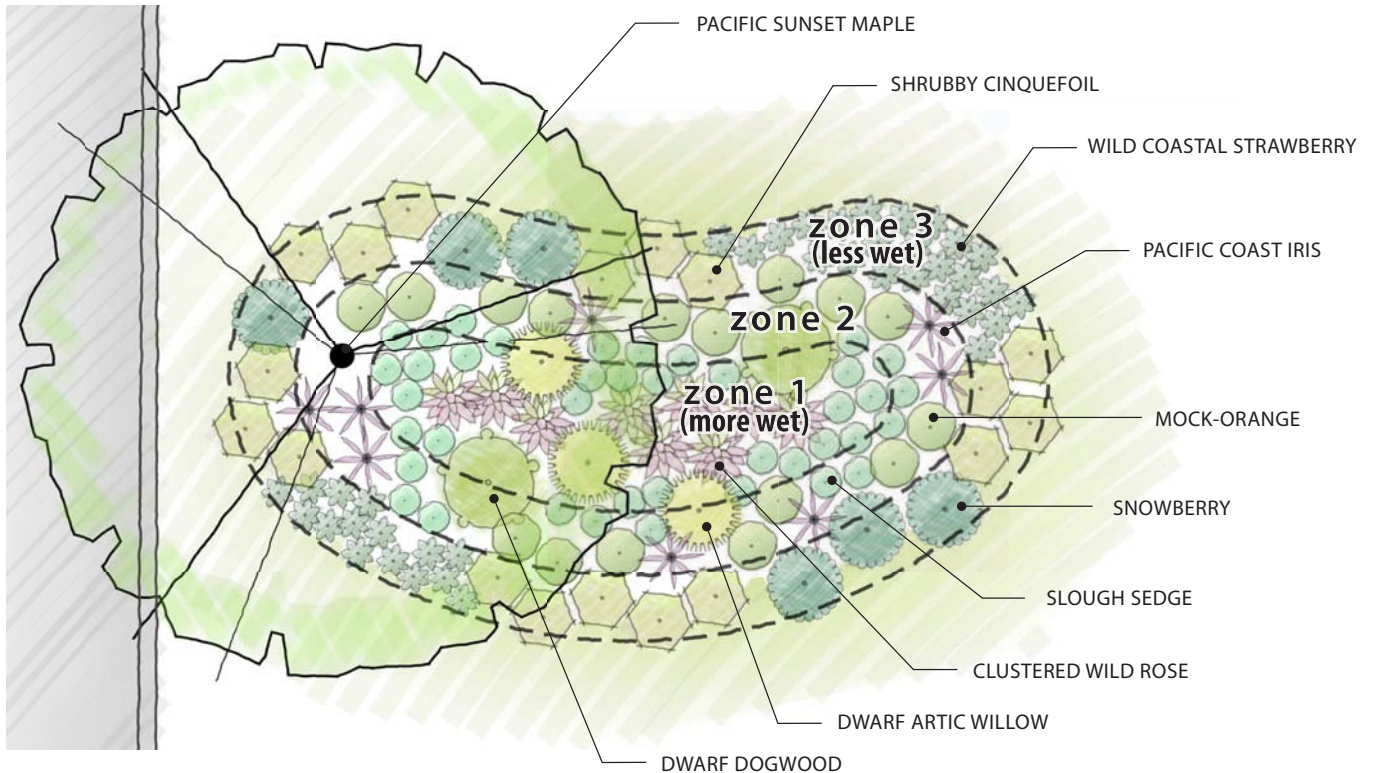

figure 6.1.24

Examples of plants appropriate for different soil moisture zones.

Source: AHBL

- Free of weed seeds, soil, roots, and other material that is not bole or branch wood and bark.
- Coarse compost in the bottom of the facility and up to the ponding elevation (compost is less likely to float when the cell is inundated).
- Arborist wood chips on side slopes above ponding elevation and rim area.
- Free of shredded wood debris to which wood preservatives have been added.
- A maximum of 2-3 inches thick. Thicker applications can inhibit proper oxygen and carbon dioxide cycling between the soil and atmosphere (Prince George's County, 2002).

Mulch should not be:

- Grass clippings (decomposing grass clippings are a source of N and are not recommended for mulch in bioretention areas).
- Pure bark (bark is essentially sterile and inhibits plant establishment).

If planting bioretention areas is delayed (e.g., BSM is placed in summer and plants are not installed until fall), mulch should be placed immediately to prevent weed establishment.

Dense groundcover enhances soil structure from root activity, does not have the tendency to float during heavy rain events, inhibits weed establishment, provides additional aesthetic appeal, and is recommended when high heavy metal loading is not anticipated. Mulch is recommended in conjunction with the groundcover until groundcover is established.

Research indicates that most attenuation of heavy metals in bioretention cells occurs in the first 1-2 inches of the mulch layer. That layer can be removed or added to as part of a standard and periodic landscape maintenance procedure. No indications of special



figure 6.1.25

Bioretention area mulch with coarse compost used in the bottom of the facility and arborist wood chips on the sides.
Source: Curtis Hinman



figure 6.1.27

Aggregate mulch is used in this high gradient bioretention swale. Plants are installed through the aggregate mulch and into the BSM below.
Source: Curtis Hinman

disposal needs are indicated at this time from older bioretention facilities in the eastern U.S. (personal communication, Larry Coffman).

In bioretention areas where higher flow velocities are anticipated, an aggregate mulch may be used to dissipate flow energy and protect underlying BSM. Aggregate mulch varies in size and type, but 1 to 1 1/2-inch gravel (rounded) decorative rock is typical (see figure 6.1.26).

6.1.2.3 Installation

Prior to construction, meet with contractor, subcontractors, construction management, and inspection staff to review critical design elements and confirm specification requirements, proper construction procedures, construction sequencing, and inspection timing.

Runoff from construction activity should not be allowed into the bioretention areas unless there is no other option for conveying construction stormwater, there is adequate protection of the subgrade soil and BSM, and introduction of stormwater is approved by the project engineer.

6

6.1 Bioretention

6.1.2 design

Excavation

Soil compaction can lead to facility failure; accordingly, minimizing compaction of the base and sidewalls of the bioretention area is critical. Excavation should never be allowed during wet or saturated conditions (compaction can reach depths of 2-3 feet during wet conditions and mitigation is likely not possible). Excavation should be performed by machinery operating adjacent to the bioretention facility and no heavy equipment with narrow tracks, narrow tires, or large lugged, high pressure tires should be allowed on the bottom of the bioretention facility. If machinery must operate in the bioretention cell for excavation, use light weight, low ground-contact pressure equipment and rip the base at completion to re-fracture soil to a minimum of 12 inches (Prince George's County, 2002). If machinery operates in the facility, subgrade infiltration rates must be field tested and compared to design rates and verified by the Engineer of Record. Failure to meet or exceed the design infiltration rate for the subgrade will require revised engineering designs to verify achievement of treatment and flow control benefits that were estimated in the Stormwater Site Plan.

Prior to placement of the BSM the finished subgrade should:

- Be scarified to a minimum depth of 3 inches.
- Have any sediment deposited from construction runoff removed (to remove all introduced sediment, subgrade soil should be removed to a depth of 3-6 inches and replaced with BSM).
- Be inspected by the engineer to verify required subgrade condition.

Sidewalls of the facility beneath the surface of the BSM can be vertical if soil stability is adequate. Exposed sidewalls of the completed bioretention area with BSM in place should be no steeper than 3H:1V (see Bottom area and side slopes in section 6.1.2.2: Bioretention components). The bottom of the facility should be flat.

Vegetation protection areas with intact native soil and vegetation should not be cleared and excavated for bioretention facilities.

Bioretention soil media installation

Placement

On-site soil mixing or placement should not be performed if BSM or subgrade soil is saturated. The bioretention soil mixture should be placed and graded by machinery operating adjacent to the bioretention facility. If machinery must operate in the bioretention cell for soil placement, use light weight equipment with low ground-contact pressure. If machinery operates in the facility, the BSM infiltration rates must be field tested and compared to design rates and verified by the project engineer. Failure to meet or exceed the design infiltration rate for the BSM will require revised engineering designs to verify achievement of treatment and flow control requirements. The soil mixture should be placed in horizontal layers not to exceed 12 inches per lift for the entire area of the bioretention facility.

Compact the BSM to a relative compaction of 85 percent of modified maximum dry density (ASTM D 1557). Compaction can be achieved by boot packing (simply walking over all areas of each lift) and then apply 0.2 inch of water per 1 inch of BSM depth. Water for settling should be applied by spraying or sprinkling.

Verification

If using the guidelines in Section 6.1.2.2: Bioretention components under Bioretention soil media, pre-placement laboratory analysis for saturated hydraulic conductivity of the BSM is not required. Verification of the mineral aggregate gradation, compost guidelines, and mix ratio in Section 6.1.2.2: Bioretention components under Bioretention soil media must be provided to verify performance guidelines in that section.

If the BSM uses a different mineral aggregate gradation, compost guidelines, and mix ratio than Section 6.1.2.2: Bioretention components under Bioretention soil media, then verification of the BSM composition (2-5 percent passing the #200 sieve, 4-8 percent OM content, CEC > 5 MEQ/100 grams dry soil, pH in the range of 5.5 – 7) and hydraulic conductivity (initial rate less than 12 inches per hour and a long-term rate more than 1 inch per hour) must be provided before placement through

laboratory testing of the material that will be used in the installation.

BSM infiltration rates are determined per ASTM Designation D 2434 (Standard Test Method for Permeability of Granular Soils) at 85 percent compaction per ASTM Designation D 1557 (Standard Test Methods for Laboratory Compaction Characteristics of Soil Using Modified Effort). Determine the organic matter content before and after permeability test using ASTM D2974 (Standard Test Method for Moisture, Ash, and Organic Matter of Peat and Other Organic Soils). Appendix 3: Recommended Procedures for ASTM D 2434 When Measuring Hydraulic Conductivity for Bioretention Soil Mixes provides guidelines to standardize procedures and reduce inter-laboratory variability when testing BSM's with mineral and organic material content.

Testing should be performed by a Seal of Testing Assurance, AASHTO, ASTM or other standards organization accredited laboratory with current and maintained certification. Samples for testing must be supplied from the BSM that will be placed in the bioretention areas.

Filter fabrics

Do not use filter fabrics between the subgrade and the BSM. The gradation between existing soils and BSM is not great enough to allow significant migration of fines into the BSM. Additionally, filter fabrics may clog with downward migration of fines from the BSM.

If testing infiltration rates is necessary for post-construction verification, use small-scale PIT method, large ring infiltration test or a double ring infiltrometer test (see Section 2.1: Soil and subsurface characterization for test details). If using the PIT method do not excavate BSM (conduct test at level of finished BSM elevation), flood whole cell, and use a maximum of 6 inch ponding depth and conduct test before plants are installed. If using the double ring infiltrometer, measurements should be taken at enough locations within the bioretention area to provide a representative infiltration rate (e.g., 2-3 locations per 50 feet).

Temporary Erosion and Sediment Control (TESC)

Controlling erosion and sediment are most difficult during clearing, grading, and construction; accordingly, minimizing site disturbance to the greatest extent practicable is the most effective sediment management. During construction:

- Bioretention areas should not be used as sediment control facilities and all drainage should be directed away from bioretention areas after initial rough grading. Flow can be directed away from the facility with temporary diversion swales or other approved protection (Prince George's County, 2002). If introduction of construction runoff cannot be avoided see below for guidelines.
- Construction on bioretention facilities should not begin until all contributing drainage areas are stabilized according to erosion and sediment control BMPs and to the satisfaction of the engineer.
- If the design includes curb and gutter, the curb cuts and inlets should be blocked until BSM and mulch have been placed and planting completed (when possible), and dispersion pads are in place (see figure 6.1.27).

Every effort during design, construction sequencing, and construction should be made to prevent sediment from entering bioretention areas. However, bioretention areas are often distributed throughout the project area and can present unique challenges during construction. See Section 5.4.1 for guidelines if no other options exist and runoff during construction must be directed through the bioretention areas.

Erosion and sediment control practices must be inspected and maintained on a regular basis.

6.1.2.4 Maintenance

Bioretention areas require periodic plant, soil, and mulch layer maintenance to ensure optimum infiltration, storage, and pollutant removal capabilities. Providing more frequent and well-timed maintenance (e.g., weeding prior to seed dispersal) during the first three

6

6.1 Bioretention

6.1.2 design



figure 6.1.27

Proper erosion and sediment control for bioretention installation. Note the pervious concrete sidewalk is protected with filter fabric and the curb inlets to the bioretention area are blocked, until site is stabilized.

Source: Curtis Hinman

years will ensure greater success and reduce future maintenance of bioretention areas. For a detailed maintenance plan, including levels of service and associated type and timing of activities, see Appendix 4. In general, bioretention maintenance requirements are typical landscape care procedures and include:

- **Watering:** Plants should be selected to be drought tolerant and not require watering after establishment (2-3 years). Watering may be required during prolonged dry periods after plants are established.
- **Erosion control:** Inspect flow entrances, ponding area, and surface overflow areas periodically, and replace soil, plant material, and/or mulch layer in areas if erosion has occurred. Properly designed facilities with appropriate flow velocities should not have erosion problems except perhaps in extreme events. If erosion problems occur, the following should be reassessed: (1) flow volumes from contributing areas and bioretention cell sizing; (2) flow velocities and gradients within the cell; and (3) flow dissipation and erosion protection strategies in the pretreatment area and flow entrance. If sediment is deposited in the bioretention area, immediately determine the source within the contributing area, stabilize, and remove excess surface deposits.

- **Sediment removal:** Follow the maintenance plan schedule for visual inspection and remove sediment if the volume of the ponding area has been compromised.
- **Plant material:** Depending on safety (pedestrian obstruction or site distances) and aesthetic requirements, occasional pruning and removing dead plant material may be necessary. Replace all dead plants, and if specific plants have a high mortality rate, assess the cause and replace with appropriate species. Periodic weeding is necessary until plants are established and adequately shade and capture the site from weed establishment.
- **Weeding:** Invasive or nuisance plants should be removed regularly and not allowed to accumulate and exclude planted species. At a minimum, schedule weeding with inspections to coincide with important horticultural cycles (e.g., prior to major weed varieties dispersing seeds). Weeding should be done manually and without

herbicide applications. The weeding schedule should become less frequent if the appropriate plant species and planting density are used and the selected plants grow to capture the site and exclude undesirable weeds.

- *Nutrients and pesticides:* The soil mix and plants are selected for optimum fertility, plant establishment, and growth. Nutrient and pesticide inputs should not be required and may degrade the pollutant processing capability of the bioretention area as well as contribute pollutant loads to receiving waters. By design, bioretention areas are located in areas where P and N levels may be elevated and these should not be limiting nutrients. If in question, have soil analyzed for fertility.
- *Mulch:* Replace mulch annually in bioretention areas where heavy metal deposition is high (e.g., contributing areas that include gas stations, ports, and roads with high traffic loads). In residential settings or other areas where metal or other pollutant loads are not anticipated to be high, replace or add mulch as needed (likely 3-5 years) to maintain a 2 to 3-inch depth.
- *Soil:* Soil mixes for bioretention facilities are designed to maintain long-term fertility and pollutant processing capability. Estimates from metal attenuation research suggest that metal accumulation should not present an environmental concern for at least 20 years in bioretention systems (see Performance section below). Replacing mulch in bioretention facilities where heavy metal deposition is likely provides an additional level of protection for prolonged performance. If in question, have soil analyzed for fertility and pollutant levels.

6.1.2.5 Performance

Flow control processes in bioretention

While original applications focused on water quality treatment, bioretention can be highly effective for reducing stormwater volume and attenuating flows. Where the surrounding native soils have adequate infiltration rates, bioretention can be used as a retention facility. Under-drain systems can be installed

in facilities where existing soils have low infiltration rates; however, uncontrolled drains rapidly convey water out of the bioretention area and decrease detention time and flow retention. Properly designed and installed bioretention have shown very good flow control performance on soils with low infiltration rates (Hinman, 2009). Accordingly, when under-drains are used, orifices or other control structures are recommended to improve flow control. Access for adding or adjusting orifice configurations and other control structures is also recommended for adaptive management and optimum performance.

Flow control processes in bioretention areas include:

- *Infiltration* is the downward migration of runoff through the planting soil and into the surrounding soils. Infiltration is the primary mechanism for attenuating storm flows in bioretention areas. In general, long-term infiltration rates degrade over time in typical infiltration facilities due to large hydrologic loads, biofilm, and sedimentation. Anecdotal information suggests that properly designed bioretention area soil infiltration rates do not degrade as rapidly and may improve over time due to biological, chemical, and physical processes that build soil structure. Focused studies have not confirmed this. The surrounding soil will be the limiting infiltration rate in till, compacted silt or clay, or other tight soils; however, there are no studies quantifying vertical and lateral subsurface flows from bioretention areas on soils with lower infiltration rates in the Puget Sound region.
- *Evaporation* can occur as precipitation is intercepted by vegetation, from surface water in the ponding area, and from exposed soil or mulch layers in bioretention areas. Evaporation from vegetation is relatively minor unless the cell has a well-developed, closed, and varied canopy.
- *Transpiration* is the movement of water from the roots through the plant supporting structure and out the stomata in leaves. Transpiration is minimal in the winter months when plants are relatively dormant; however, some transpiration may occur in bioretention areas in winter. No

6

6.1 Bioretention

6.1.2 design

research is available estimating the transpiration component of evapotranspiration in the winter for bioretention areas.

Flow control performance

In the City of Seattle, Seattle Public Utilities (SPU) narrowed 660 feet of conventional residential road and installed bioretention swales within the right-of-way as part of the Street Edge Alternatives (SEA) project. The contributing area with swales is approximately 2.3 acres. Soils underlying the bioretention swales are heterogeneous till-like material with lens of silt, sand, and gravel of varying permeability. Some of the swales are lined with bentonite to restrict infiltration and reduce concerns of wet basements in homes near the swales. Flows for the conventional pre-construction street were compared to the retrofit design. During the pre-construction period (March-July 2000), 7.96 inches of rainfall produced 4979 cubic feet of runoff. During the post-construction period (March-July 2001), 9.00 inches of precipitation produced 132 cubic feet of runoff. Post-construction runoff volumes were reduced by approximately 97 percent compared to pre-construction volumes. An October 2003 record storm event (4.22 inches with a 32.5 hour storm duration) produced no runoff (Horner et al., 2002).

“Post-construction runoff volumes were reduced by approximately 97 percent compared to pre-construction volumes. An October 2003 record storm event (4.22 inches with a 32.5 hour storm duration) produced no runoff (Horner et al., 2002).”

In a subsequent study, SPU evaluated 4 blocks of the 110th Street Cascade bioretention system (high gradient with no under-drains) for flow control. The surface (mulch) layer is gravel to prevent erosion with compost amended soil beneath. The subgrade is composed of till-like soils. The portion of the system that was monitored manages runoff from a contributing area that is approximately 7.3 hectare (43 percent impervious, 57 percent lawns). Over 3 full wet seasons the bioretention areas retained 48 percent of flow measured at the inlet. When estimated flow inputs

between inlet and outlet of the monitored section plus flow measured at the inlet were considered together, the system retained 74 percent of the total stormwater volume entering the system (Chapman and Horner, 2010).

In a study of a 3.35-hectare, 35-home residential LID pilot project in southern Puget Sound that incorporates LID stormwater management practices, total precipitation volume retained and measured at the final outfall was 96 percent during the 2007-2008 wet season. At the same project, surface and sub-surface flows were monitored for a 0.32 hectare sub-basin including 7 homes and 4 bioretention areas. During the 2007-2008 wet season, the bioretention areas retained 99 percent of the total precipitation volume and the sub-basin met Ecology’s flow control standard for pre-development forested condition. Soils at the project were characterized as silt loam overlying cemented till with measured infiltration rates of 0.0 to 6.35 cm/hr. (Hinman, 2009).

Pollutant removal processes in bioretention

All primary pathways for removing pollutants from storm flows are active in bioretention systems. Schueler and Clayton (1996) list the following primary pathways:

- *Sedimentation* is the settling of particulates (which is not effective for removing soluble components). Sedimentation occurs in the pretreatment (if provided) and ponding area of the facility.
- *Filtration* is the physical straining of particulates (which is not effective for removing soluble components). Some filtration occurs in the ponding area as stormwater moves through plants, but the soil is the primary filtering media. Pitt et al. (1995) report that 90 percent of small particles commonly found in urban storm flows (6 to 41 microns) can be trapped by an 18-inch layer of sand. This level of performance can be anticipated for bioretention soils typically high in sand content.
- *Adsorption* is the binding of ions and molecules to electrostatic receptor sites on the filter media

particles. This is the primary mechanism for removing soluble nutrients, metals, and organics that occur in the soil of bioretention areas as storm flows infiltrate. Adsorption increases with increased organic matter, clay, and a neutral to slightly alkaline pH.

- *Infiltration* is the downward movement of surface water to interstitial soil water. This process initiates adsorption, microbial action, and other processes for pollutant removal.
- *Phytoremediation* processes include degradation, extraction by the plant, containment within the plant (assimilation) or a combination of these mechanisms (USEPA, 2000). Studies have shown that vegetated soils are capable of more effective degradation, removal, and mineralization of total petroleum hydrocarbons (TPHs), polycyclic aromatic hydrocarbons (PAHs), pesticides, chlorinated solvents, and surfactants than non-vegetated soils (USEPA, 2000). Certain plant roots can absorb or immobilize metal pollutants, including cadmium (Cd), copper (Cu), nickel, zinc (Zn), Pb, and chromium, while other species are capable of metabolizing or accumulating organic and nutrient contaminants. A University of Maryland study found significant metal accumulation in creeping juniper plants in pilot-scale bioretention cells. Copper increased by a factor of 6.3, Pb by a factor of 77, and Zn by a factor of 8.1 in the tissue of junipers after receiving synthetic stormwater applications compared to pre-application tissue samples (Davis, Shokouhian, Sharma, Minami and Winogradoff, 2003). An intricate and complex set of relationships and interactions between plants, microbes, soils, and contaminants make these various phytoremediation processes possible.
- *Plant resistance* occurs as plant materials reduce flow velocities and increase other pollutant removal pathways, such as sedimentation, filtering, and plant uptake of pollutants during growth periods.
- *Volatilization* occurs when a substance is converted to a more volatile vapor form.

Transforming complex hydrocarbons to carbon dioxide is an example of volatilization active in bioretention cells (Prince George's County, 2002).

- *Thermal attenuation* reduces water temperatures as storm flows move through subsurface soil layers.

Pollutant removal efficiency in bioretention areas

Metals

Laboratory and field research indicates that bioretention areas have excellent capability to capture heavy metals. Duration and flow rate can influence removal at shallow depths (10 inches), but not deeper in the soil profile (36 inches). Metal adsorption in soil is typically influenced by pH; however, the buffering capacity in the bioretention soil mix effectively negates the influence of pH variations in synthetic pollutant mixtures applied to pilot-scale systems (Davis et al., 2003). The most significant metal uptake occurs in the mulch layer that can retain a large portion of the total metals loads (Davis et al., 2001). Table 6.1.6 provides data summarizing research on other typical stormwater BMPs for comparison.

Subsequent studies confirm the metal capture capability of bioretention. Sun and Davis (2006) applied dissolved metals in synthetic storms to columns with grasses. Overall metal capture in the columns was good for both low and high loading regimes: Zn (l) 94 percent, (h) 97 percent; Cu (l) 88 percent, (h) 93 percent; Pb (l) 95 percent, (h) 97 percent; Cd (l) >95 percent, (h) >98 percent. Type of grass species did not significantly affect metals capture; however, the concentration of metals in the plant material did vary among grass species. Mass distribution of metals was 88-97 percent in soil media, 0.5-3.3 percent accumulated in plants, and 2.0-11.6 percent in effluent.

Godecke et. al. (2009) examined the effect of wetting and drying and the presence of a saturated zone (with and without a carbon source) on the capture and accumulation of heavy metals in columns with plants. Soil cores were taken at various depths. Soil

6

6.1 Bioretention

6.1.2 design

table 6.1.5 Percent pollutant removal by depth and bioretention.

Depth (inches)	Cu (µg/L)	Pb (µg/L)	Zn (µg/L)	P (mg/L)	TKN (mg/L)	NH4 (mg/L)	NO3 (mg/L)	TN (mg/L)
10	90	93	87	0	37	54	-97	-29
22	93	>97	>96	73	60	86	-194	0
36	93	>97	>96	81	68	79	23	43

Adapted from Davis et al., 1998 (removal percentages are for total metals)

media was comprised of sandy loam (top layer), fine sand (filter layer), coarse sand (transition layer), and fine gravel (drainage layer). Good metals capture was observed during wet periods with or without saturated zone and carbon source: Cu with = 95.2 percent ± 5.7, without = 88 percent ± 3; Pb with and without = 99.2 percent ± 0.9; Zn with and without = 97.4 percent ± 1.7; Cd with and without = > 89.6 percent; TSS with = 97.5 percent ± 2, without = 98.3 percent ± 1.3. Copper capture did improve with saturated zone. No effect of drying was detected in columns with saturated zones and carbon source. Most metals were captured at the top of the filter and concentrations were generally below detection limits at depths below 200 millimeters. Even with long drying periods and no saturated or carbon source, filters performed well (Cu = 70 percent capture, Zn and Pb = 90 percent capture).

Li and Davis (2008) analyzed soil profile samples collected at a bioretention cell constructed in 2001 with a 0.77 hectare parking lot contributing area. Samples were analyzed for heavy metal concentrations. The cell was approximately 4.5 years old when sampled. Accumulation of Zn and Pb was mostly at the surface of the bioretention cell. Below 10 cm concentrations were at background levels. Accumulation of Cu in surface layers was less prevalent and there was more association of Cu with lower media layers. The association of Cu with soil particles was weaker than Zn and Pb, and Cu tended to associate with organic

matter (OM) that can be discharged with dissolved OM in bioretention effluent. Fractions of soluble-exchangeable metals (which is an indicator for leaching or bioavailability) was Zn>Cu>Pb. The analysis found low fractions of soluble-exchangeable metals, indicating metals were tightly bound to street dirt particles or media.

Finally, Hinman (2009) found metals below detection limits in the effluent of a 3.35-hectare, 35-home residential LID pilot project in southern Puget Sound with bioretention as the primary stormwater management practice. Dissolved Pb, Cu, and Zn were <0.002 µg/L, <0.02 µg/L, <0.05 µg/L, respectively at the point of compliance. Influent to bioretention areas was highly distributed and characterizing influent concentrations was not feasible. Only two storms were analyzed.

Stormwater pollutants (particularly metals) can disrupt normal soil function by lowering cation exchange capacity. The oldest bioretention areas operating in the U.S. (approximately 20 years old) appear to develop soil structure and maintain soil functions that actually enhance pollutant processing capability (Prince George's County, 2002). Modeling estimates and field research suggest that metals accumulation would not present an environmental concern for at least 20 years in bioretention systems (Davis et al., 2003).

table 6.1.6 Comparative pollutant removal capability of stormwater treatment practices (in percentages).

Pollutant	Dry Extended Detention	Wetlands	Water Quality Swales	Ditches
TN (mg/L)	31	30	84	-9
NO3 (mg/L)	ND	ND	ND	ND
P (mg/L)	20	49	34	-16
Cu (µg/L)	26	40	51	14
Pb (µg/L)	54	68	67	17
Zn (µg/L)	26	44	71	0

Adapted from CWP, 2000b (removal percentages are for total metals)

Hydrocarbons and bacteria

Hong, Seagren and Davis (2002) examined the capacity of a mulch layer to capture oil and grease via sorption and filtration. Simulated stormwater runoff carrying naphthalene was applied to a bench-scale “reactor” with a 3-cm thick leaf compost layer. During the simulated storm event, approximately 90 percent of dissolved naphthalene was removed from aqueous phase via sorption. After the simulated storm event (37 and 40 hours), approximately 32 percent of the naphthalene was removed from the solid phase via biodegradation in the mulch layer where the microbial population had been inhibited. Approximately 72 percent of the naphthalene was removed from the solid phase via biodegradation in the mulch layer at 37 and 40 hours and 95 percent after 74 hours where the microbial population was not inhibited. Losses due to volatilization were negligible.

At the University of New Hampshire Stormwater Center, stormwater flows were distributed equally to various stormwater management practices from a 9-acre parking lot to compare the pollutant removal efficiency and flow control of each practice. Bioretention removal efficiency was 99 percent for TPH-diesel.

Chapman and Horner (2010) examined surface flow from roadside bioretention swales in Seattle and found 96 percent reduction from influent to effluent for TPH.

As part of a larger BMP performance monitoring program, Hathaway et. al. (2009) collected inflow and effluent grab samples for 12 stormwater BMPs. BMPs included 2 dry detention basins, 1 pond, 2 stormwater wetlands, 1 bioretention area, and 3 proprietary devices. Fecal coliform and E. coli were evaluated. The best performing BMPs for bacteria concentration reduction efficiency were bioretention and one of the

6

6.1 Bioretention

6.1.2 design

wetlands, with the following results: Fecal Coliform: wetland = 0.98, bioretention = 0.89, E. coli: wetland = 0.96; bioretention = 0.92.

concentration reduction efficiency=

$$1 - \left(\frac{\text{geometric avg. outlet conc.}}{\text{geometric avg. inlet conc.}} \right)$$

Rusciano and Obrupta (2007) examined TSS and FC bacteria capture in bioretention soil media. Columns were filled with planting substrate (equal parts sphagnum peat, triple shredded mulch and clean sand), 30.4 cm clean sand, filter fabric, and pea gravel from top to bottom. Manure was mixed to concentrations typical in stormwater and applied to columns at the rate of 77 ml/min. over a period of 9 months (17 simulated storm events). Soil analysis at various depths was conducted after dosing. Mean reduction of TSS = 91.5 percent (range from 81.0-99.4 percent) and FC = 95.9 percent (range from 54.0-99.8 percent). Influent concentrations for FC increased percent removal, but also effluent concentrations. FC colony forming units were observed in the post-dosing soil analysis from the depth 0-5.1 cm only.

Thermal attenuation

A field study in Maryland found that the temperature of the input water was reduced by approximately 12 degrees C after infiltrating through a bioretention cell located in a parking lot (USEPA, 2000a).

Phosphorus

While metals, hydrocarbon, TSS, bacteria, and possibly organics capture in bioretention areas is very good to excellent, nutrient management presents particular challenges. The BSM contains compost and therefore, a bank of nutrients. Nitrate-nitrogen (NO₃-N) and phosphate (PO₄) are bio-available forms of N and P and are of particular concern for eutrophication of fresh and marine receiving waters.

Geochemical cycling

Phosphorus cycling in soils and through bioretention systems is complex. The majority of particulate P is phosphorus that is adsorbed onto clay fractions

containing iron and aluminum oxides and/or precipitated with iron and/or calcium (Lucas, 2011). Adsorption reactions on media surfaces are relatively fast compared to calcium phosphate precipitation (a relatively irreversible reaction) and deposition of P within aluminum and iron oxide mineral structures (a more reversible reaction) (Zhang et. al., 2008). The reversibility of these reactions depends primarily on dissolved PO₄ concentrations, redox status, and pH (Lucas, 2011). For example, in anoxic conditions iron reduction (ferric to ferrous species) will release PO₄ from precipitates (Lucas, 2011).

Lucas and Greenway (2008) observed very good PO₄ capture by adding iron and aluminum oxides in the form of WTRs to their bioretention soil media. The iron and aluminum oxides provide adsorption sites for PO₄; however, these reactions may be reversible at lower pH and redox potentials. Davis et al. (2001) found P removal in bioretention soils increases with depth of facility. Increased contact time and sorption of P onto aluminum, iron, and clay minerals in the soil is the likely mechanism of removal.

Availability of P is one of several parameters to determine the risk of P transport from agricultural land to fresh water systems. The sum of this analysis results in a P-index and includes rain fall, irrigation, erosion potential (i.e. slope, hydraulic conductivity, soil and crop management), and fertilizer application (Elrashidi, 2001). In properly designed bioretention systems, erosion, nutrient application, and irrigation should not be of concern, especially once plants and soil structure are established. Accordingly, P availability is likely the single most important assessment from the P-index to indicate potential P transport from bioretention areas. Excessive levels of available P (>100 to 250mg/kg depending on test used) suggest that bio-available P can exceed plant need or uptake and contribute to the pool of water-soluble P that may be present in surface flow or soil water effluent (Stevens, 2008). Additional work is needed to correlate these agricultural tests in bioretention systems and to test available P when a bioretention soil mix is placed and then after the soil is planted and soil structure is improving.

Biological cycling

While the geochemical cycling of P is important for determining P availability, bacteria and fungi are capable of rapid uptake and immobilizing of P and N. Of course plants require and take up N and P for growth; however, plants also provide a primary source of energy (carbohydrates) through root exudates and decomposition that support soil microbial activity. Lucas and Greenway (2008) observed significantly higher P capture due to microbial immobilization in planted compared to unplanted mesocosms.

Organic and inorganic P can be leached from compost amended soils and while some of the P load leached from compost is in a less readily available form, the negatively charged organic matter can displace considerable amounts of PO₄ available in the media (Lucas, 2011; Pitt and Clark, 2009).

Nitrogen

Research has observed good nitrate retention and at times nitrate production and export in bioretention systems.

Geochemical cycling

Production or export of NO₃-N is likely a result of organic and ammonia N that is converted to nitrate NO₃-N between storms (presumably through the ammonification and nitrification process). NO₃-N is then washed from the facility during subsequent storm events (Kim et al., 2003).

In laboratory columns, Kim et al. (2003) observed improved reduction of NO₃-N concentrations by creating an anaerobic zone with a suitable carbon source (e.g., wood chips mixed in the gravel) acting as an electron donor or energy source for denitrifying bacteria. The fluctuating aerobic/anoxic zone promotes denitrification (transformation of NO₃-N to N gas) and improve nitrate removal. Davis (2001) also showed improved nitrate removal by simply increasing the BSM depth to 24-36 inches. However, Hunt et al. (2006) did not observe improved nitrate removal in bioretention field sites comparing bioretention cells with and without saturated zones at the bottom of the facilities. The

Davis study showing improved NO₃-N with increased BSM depth may have been a result of small saturated zones within the soil matrix and additional NO₃-N contact time through the soil column. Soil water and oxygen level characteristics are highly dependent on soil texture, soil structure and plants; accordingly, soil depth and NO₃-N removal requires additional analysis.

Biological cycling

In a large study with 125 columns and treatments including various plants, soil media blends, media depth and area, pollutant inflow concentrations, and hydraulic loads, Bratieres et. al. (2008) found vegetation selection important for nutrient management (*Carex appressa* and *Meleleuca ericifolia* performed best). Additional findings in this study include: bioretention built to optimal specification can reliably capture 70 percent of N and 85 percent of P; all columns effectively removed TSS (95%); increasing filter depth increased NO_x effluent concentration, but performance improved as plants matured in deeper columns; filter media depth showed no effect on total phosphorus (TP) or phosphate capture.

Lucas and Greenway (2008) examined retention of P and N in 240-liter mesocosms with various soil mixes. Half were vegetated with shrubs and grasses and half barren. Total P retention in the vegetated loam was 91 percent compared to 73 percent in the barren loam and total nitrogen (TN) retention was 81 percent in the vegetated loam compared to 41 percent in the barren loam. TP retention was 86-88 percent in the sand treatments and TN retention was 64 percent in the vegetated sand compared to 30 percent in the barren sand. The TP and TN retention significantly exceeds uptake rates for plants, suggesting that there are additional processes involved for nutrient retention and transformation in the soil.

THIS PAGE
INTENTIONALLY
LEFT BLANK

6.2 Amending Construction Site Soils

Native soils are highly complex systems that provide essential environmental benefits including: physical filtration, chemical transformation, and biological uptake of pollutants; nutrients for plant growth; and the storage and slow release of storm flows. The ability of soil to effectively store and slowly release water is dependent on soil texture, structure, depth, organic matter content, and biota (Washington Organic Recycling Council [WORC], 2003). Plant roots, macro fauna, and microbes tunnel, excavate, penetrate, and physically and chemically bond soil particles to form stable aggregates that enhance soil structure and porosity. The micro-and macro-pores created by the enhanced structure improve water-holding capability, increase infiltration capacity, increase oxygen levels, and provide a variety of habitats necessary to support thousands of different organisms within the soil (Allen, 1994 and CH2M HILL, 2000).

Organic matter is a critical component of a functioning soil system. Mixed into the soil, organic matter absorbs water, physically separates clay and silt particles, and reduces erosion (Balousek, 2003 and WORC, 2003). Microbial populations and vegetation depend on the replenishment of organic matter to retain and slowly release nutrients for growth (Chollak, n.d.). Typically, native Puget Sound forest soils have an organic matter content of 4-6 percent and the sub-soils less than 1 percent (Chollak, n.d.). Construction activity typically removes the upper layers of soil, compacts exposed sub-soils low in organic matter, and alters the site's hydrologic characteristics by converting the predominantly subsurface flow regime of the pre-disturbance site to primarily overland flow.

Current landscape practices often do not require adequate preparation of turf and planting bed areas in order to regain the hydrologic and plant growth benefits of native soils. As a result, compacted, unamended soil in landscaped areas can behave similarly to impervious surfaces by generating considerable overland or shallow flows just below the surface of the

“A three-year study of a 17-hectare developed catchment near Seattle (approximately 71 percent coverage in lawn, gardens, and common areas) found that 60 percent of the total overland and rapid subsurface flow came from landscaped areas during large storms.”

ground that rapidly reach receiving waters. A three-year study of a 17-hectare developed catchment near Seattle (approximately 71 percent coverage in lawn, gardens, and common areas) found that 60 percent of the total overland and rapid subsurface flow came from landscaped areas during large storms (Wigmosta, Burges and Meena, 1994). Without proper treatment and maintenance, compacted soil in lawn areas can take several years to decades to recover any beneficial infiltration and water storage characteristics of the pre-development condition (Legg, Bannerman and Panuska, 1996).

The following section focuses on soil amendment guidelines for general landscape and vegetation protection areas to meet the provisions of BMP T5.13 “Post Construction Soil Quality and Depth” in Ecology’s *SWMMWW*. For specific application of soils in bioretention facilities see Section 6.1: Bioretention. Soil protection and restoration must also be coordinated with the TESC and grading plans in the Stormwater Pollution Prevention Plan (SWPPP) for the site. Techniques for site clearing and minimizing grading to reduce soil impacts and transportation costs are provided in Chapter 5: Precision Site Preparation, Grading and Inspection of LID Facilities.

6

6.2 Amending construction site soils

6.2.1 applications / 6.2.2 design & implementation

6.2.1 Applications

The hydrologic characteristics of disturbed construction site soils for commercial, residential, and industrial projects, whether new or retrofit, can be enhanced with the addition of organic matter (CH2M HILL, 2000). In a low impact development, the landscape component of the project enhances water storage, attenuates storm flows, and is integral to the stormwater management design. When properly implemented and maintained, incorporating compost into disturbed soils provides hydrologic, as well as other important environmental functions including:

- Improved soil structure and porosity and reduced bulk density (US Composting Council, 2005).
- Increased infiltration (US Composting Council, 2005).
- Increased moisture holding capacity (US Composting Council, 2005).
- Increased cation exchange capacity, pollutant adsorption, and filtration (US Composting Council, 2005).
- Buffers soil pH (US Composting Council, 2005)
- Improved plant growth, disease resistance, and overall aesthetics of the landscaping.
- Reduced (or elimination of) pesticide and fertilizer inputs for plant maintenance.
- Reduced peak summer irrigation needs (Chollak, n.d.).

Organic matter derived from compost, stockpiled on-site soil, or imported topsoil can be beneficial in all areas subject to clearing and grading. Engineered structural fill or LID drainage facilities will have specific design requirements for soil (see Section 6.1 for soil specifications in bioretention areas and Section 6.4: Urban Trees for soil requirements in tree planting areas). Application rates and techniques for incorporating amendments will vary with the use and plant requirements of the area. For example, amendment depths will be less in tree root protection zones than in new turf and planting beds, and turf areas typically are amended at a lower rate than planting beds (see Section 6.2.2: Design and implementation for details).

6.2.2 Design and implementation

Much of the information supplied here is a summary of Building Soil: Guidelines and Resources for Implementing Soil Depth and Quality BMP T5.13 in the 2012 SWMMWW (Stenn, 2003). An update of this guidance is available at: <http://www.soilsforsalmon.org>. For more detail on specifications, verification, inspection procedures, and additional resources consult the above-cited manual.

6.2.2.1 Developing a soil management plan

Protecting or enhancing construction site soil requires planning for proper construction sequencing to reduce construction impacts and to delineate soil and vegetation protection areas, soil enhancement areas, access roads, and locations for material storage. These areas should be clearly delineated on the site or grading plan and communicated to contractors. At a minimum, the soil management plan (SMP) should include: 1) a site plan drawing; and 2) a soil, compost, and mulch worksheet showing:

- Soil, vegetation, and tree protection zones (show clearing limits and/or soil stockpile areas if applicable).
- Soils that will be disturbed during construction and will be improved and re-vegetated.
- Soils disturbed by previous development and will be improved and re-vegetated.
- Locations for laydown and storage areas, construction vehicle access and haul roads, temporary utilities, and construction trailers (all of the above should be located outside protection areas). These areas will need to be restored by breaking up compaction and amending the soil at the end of construction.
- How protection areas and soil enhancement areas will be protected from compaction.
- Treatment details for each area scheduled for soil enhancement (disturbed soil areas) and calculations of the quantities of compost and/or compost-amended topsoil and mulch that will be used to meet the provisions of BMP T5.13.

The SMP should also show intended locations of permanent infiltration facilities (pervious pavement, bioretention, etc.) and be coordinated with the TESC/SWPPP to prevent unintended erosion or sedimentation of infiltration areas. Check with the permitting jurisdiction for SMP requirements within the permit and construction process.

To determine the treatment details for disturbed soils that will be amended, the following 5 steps should be completed:

1. Review site grading and landscape plans.
2. Visit site to determine soil conditions prior to construction.
3. Select amendment option(s).
4. Identify compost or topsoil for amendment and mulch.
5. Calculate compost, topsoil, and mulch volumes.

More information on each step can be found in the above-mentioned Building Soil: Guidelines for Implementing BMP T5.13, available at www.soilsforsalmon.org or www.buildingsoil.org.

Characteristics of soils to promote infiltration and healthy vegetation

To enhance the hydrologic and other environmental benefits of disturbed soils in a low impact development, the existing disturbed or amended topsoil should have the following characteristics:

- A target organic matter content of 8-10 percent by dry weight for all planting beds and other landscaped areas except turf. Organic matter (OM) content is measured in soil laboratories using dried sample by the loss-on-ignition test. Acceptable test methods for determining OM include the most current version of ASTM D2974 (Test Methods for Moisture, Ash, and Organic Matter of Peat and Other Organic Soils), and TMECC 05.07A (Loss-On-Ignition Organic Matter Method). Organic matter tests are not needed when using the Pre-approved amendment rates shown below.
- A target organic matter content of 3-5 percent in turf areas. An exception is sand-based turf sports

fields, which require specialized soil mixes with typically lower organic content but a similar depth of free-draining sandy soil.

- pH between 6.0 and 8.0 or a pH appropriate for installed plants.
- A minimum organic-amended depth of 8 inches (except in tree root protection areas). See “Methods to achieve recommended soil characteristics” below for details).
- Subsoils below topsoil applications should be scarified to a depth of at least 4 inches and some topsoil material incorporated to prevent stratification for a finished un-compacted soil depth of 12 inches. See tilling recommendations below for specific application methods.
- Planting beds should be mulched after planting with 2 to 3 inches (maximum) of organic material such as arborist wood chips.

Pre-approved amendment rates

The simplest way to calculate soil and amendment needs is to use these pre-approved rates:

- Planting Beds: 8-10 percent organic content using 3 inches of compost incorporated to an 8-inch depth or a topsoil mix containing 35-40 percent compost by volume.
- Turf Areas: 3-5 percent organic matter content using 1.75 inches of compost incorporated to an 8-inch depth or a topsoil mix containing 20-25 percent compost by volume.

Calculating custom amendment rates to meet organic matter requirements

The target organic matter content may be achieved by using the pre-approved amendment rates outlined above or by calculating a custom amendment rate for the existing site soil conditions. The pre-approved rates simplify planning and implementation; however, the organic matter content of the disturbed on-site topsoils may be relatively good and not require as much amendment material. In many cases, calculating a site-specific rate may result in significant savings in amendment material and application costs.

6

6.2 Amending construction site soils

6.2.2 design & implementation

Calculating a custom rate requires collecting soil samples from the area to be amended and compost material. The soil is then tested for bulk density and percent organic matter. The compost is tested for bulk density, percent organic matter, and moisture content. Compost and topsoil producers can often supply the required information for the amendment material; however, on-site analysis would be necessary if vendor-supplied analysis is not available. See *Building Soil: Guidelines and Resources for Implementing Soil Depth and Quality BMP T.5.13* in the 2012 SWMMWW (Stenn, 2003) for additional information on testing and custom-calculation procedures, available at www.soilsforsalmon.org. A spreadsheet that performs these calculations is available on that website at: www.soilsforsalmon.org/excel/Compost_Calculator.xls. Another easy to use calculator is available at: http://your.kingcounty.gov/solidwaste/compost_calculator.htm.

Custom compost application rates are calculated using the following equation:

$$CR = D \times \frac{SBD (SOM\% - FOM\%)}{SBD (SOM\% - FOM\%) - CBD (COM\% - FOM\%)}$$

Where:

CR = compost application rate (inches)

D = finished depth of incorporated compost (inches)

SBD = soil bulk density (*lb/cubic yard dry weight*)

SOM% = initial soil organic matter

FOM% = final target soil organic matter (*target will be 5% or 10% depending on turf or landscape area*)

CBD = compost bulk density (*lb/cubic yard dry weight*)

COM% = compost organic matter (%)

Methods to achieve recommended soil characteristics

Recommended soil characteristics can be achieved by the following methods: 1) Set aside and protect native soil and vegetation areas; 2) Amend existing disturbed topsoil or subsoil; 3) Stockpile on-site topsoil from cleared and

graded areas and replace prior to planting; or 4) Import topsoil with required organic matter content standards. More than one method can be used on different portions of the same site. Slope, accessibility, stockpile area available, cost, and intended plant material may be part of the decision of which option to use where.

1. Set aside and protect native soil and vegetation areas.

The most effective and cost efficient method for providing the hydrologic benefits of healthy soil is to designate and protect native soil and vegetation areas. If these areas are protected from all impacts throughout construction, they do not have to be amended or restored. See Chapter 3: Site Planning, Chapter 4: Vegetation and Soil Protection and Reforestation, and Chapter 5: Precision Site Preparation, Grading and Inspection of LID Facilities.

2. Amend existing disturbed topsoil or subsoil.

Till compost into soil to an 8-inch depth, fully mixing the organic matter into that zone. If soil has been compacted by construction traffic, scarify the subsoil 4 inches below that 8-inch organic zone to achieve a 12-inch depth of uncompacted soil (see figure 6.2.1).

- *Planting Beds (target 8-10 percent organic content):* Place and till 3 inches (or custom calculated amount) of compost into the upper 8 inches of soil. Rake beds smooth, remove rocks larger than 2 inches in diameter. Mulch beds after planting with 2-3 inches of organic mulch such as arborist wood chips.
- *Turf Areas (target 3-5 percent organic content):* Place and till 1.75 inches (or custom calculated amount) of compost into the upper 8 inches of soil. Water or roll to compact soil to 85 percent of maximum. Rake to level, and remove surface woody debris and rocks larger than 1 inch in diameter.
- *Existing trees:* Do not scarify soil within the drip-line of existing trees to be retained. Amendment should be incorporated no deeper than 3-4 inches within 3 feet of the tree drip-line (or Critical Root Zone as determined by an arborist) to reduce damage to roots.

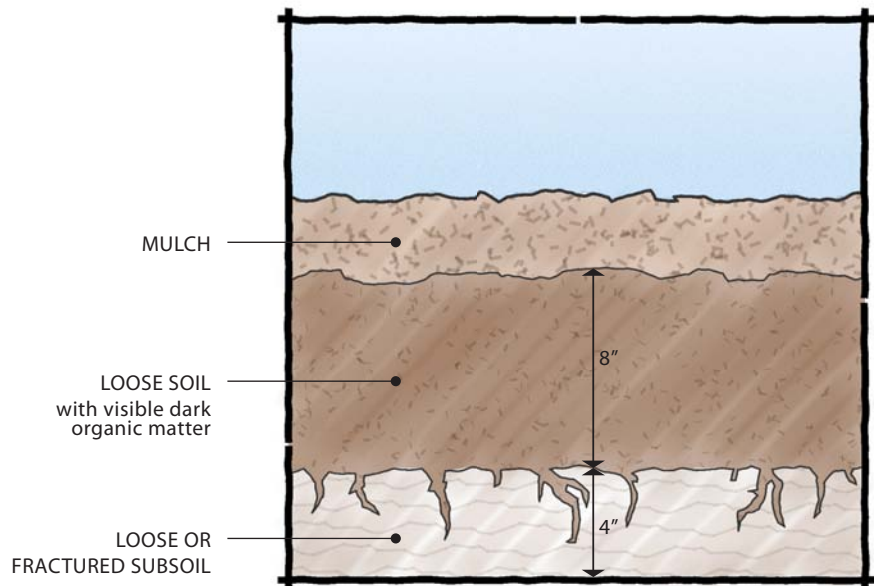
**figure 6.2.1**

Properly amended soil section
Source: AHBL

3. Stockpile topsoil from cleared areas, amend if necessary, and replace prior to planting.

Stockpile and cover soil with 3 inches of wood chips, weed barrier or other breathable material that sheds moisture yet allows air transmission in approved location prior to grading. Test the stockpiled material for OM content to determine whether additional compost must be tilled into the stockpiled soil to meet the required OM targets (see “Calculating custom amendment rates” earlier in this section). Replace stockpiled topsoil prior to planting. If replaced topsoil plus compost or other organic material will amount to less than 12 inches, scarify or till subgrade to a depth needed to achieve 12 inches of loosened soil after topsoil and amendment are placed.

- *Planting Beds* (target 8-10 percent organic content): Place and till 3 inches of compost (or custom calculated amount depending on stockpiled soil’s tested organic content) into upper 8 inches of soil. Rake beds to smooth, remove rocks larger than 2 inches in diameter. Mulch beds after planting with 2-3 inches of organic mulch or stockpiled duff.
- *Turf Areas* (target 3-5 percent organic content): Place and till 1.75 inches (or custom calculated amount) of compost into the upper

8 inches of soil. Water or roll compact soil to 85 percent of maximum. Rake to level, and remove surface woody debris and rocks larger than 1 inch in diameter.

- *Existing trees*: Do not scarify soil within drip-line of existing trees to be retained. Amendment should be incorporated no deeper than 3-4 inches within 3 feet of tree drip-line to reduce damage to roots.
- ### 4. Import topsoil with required organic matter content standards.
- Scarify or till subgrade in two directions to at least a 4-inch depth before placing 8 inches of imported topsoil. The entire surface should be disturbed by scarification.
- *Planting Beds* (target 8-10 percent organic content): Use imported topsoil mix containing 8-10 percent organic matter (typically around 35-40 percent compost by volume in the soil mix). The mineral portion must be sand or sandy loam as defined by the U.S. Department of Agriculture (USDA) soil classification system and should have less than 20 percent pass through a #200 sieve and 100 percent should pass through a ¾-inch screen (WORC, 2003). Place 3 inches

6

6.2 Amending construction site soils

6.2.2 design & implementation

of imported topsoil mix on surface and till into 2 inches of soil. Place 3 inches of topsoil mix on the surface. Rake smooth, and remove surface rocks over 2 inches in diameter. Mulch beds after planting with 2-3 inches of organic mulch.

- Turf Areas (target 3-5 percent organic content): Use imported topsoil mix containing 3-5 percent organic matter (typically around 20-25 percent compost by volume in the soil mix). Soil portion must be sand or sandy loam as defined by the USDA soil classification system and should have less than 20 percent pass through a #200 sieve and 100 percent should pass through a ¾-inch screen (WORC, 2003). Place 3 inches of topsoil mix on surface. Water or roll to compact soil to 85 percent maximum. Rake to level and remove surface rocks larger than 1 inch in diameter. The soil portion of the topsoil must be sand or sandy loam as defined by the USDA soil classification system. The soil and compost mix should have less than 25 percent pass through a #200 sieve and 100 percent should pass through a ¾-inch screen (WORC, 2003).
- Do not scarify soil within drip-line of existing trees to be retained. Amendment should be incorporated no deeper than 3-4 inches within 3 feet of tree drip-line to reduce damage to roots.

6.2.2.2 Verifying soil quality and depth

The following steps are provided to help inspectors verify guidelines summarized in this section and provided in Building Soil: Guidelines and Resources for Implementing Soil Depth and Quality BMP T5.13 in the 2012 SWMMWW (Stenn, 2003). These steps may be completed during multiple visits as a project progresses or in one final project approval inspection, depending on local practices.

Step1: Compare site conditions with the approved SMP.

- The SMP approved with the site permit describes soil treatments approved for each area. Make

sure site conditions match these details in the SMP:

- Site location and permit holder.
- Turf and planting areas match approved drawings.
- Areas to remain as undisturbed native soil and vegetation have been fenced off during construction to prevent soil compaction or damage to plants.

Step 2: Inspect delivery tickets for compost, topsoil, and mulches.

- The permittee must provide original delivery tickets for all soil and mulch products. Compare delivery tickets with the SMP to match the following information:
 - Delivery location.
 - Total quantities for each soil product and mulch.
 - Product descriptions and sources. If materials other than those listed in the SMP were delivered, laboratory test results must be provided to confirm that they are equivalent to approved products.

Step 3: Verify depth of amended soil and scarification.

- Use a shovel to dig at least one test hole per acre for turf and one per acre for planting beds to verify 8-inch topsoil depth (below mulch layer), incorporation of amendments, and 4 inches of uncompacted subsoil.
- The top 8 inches of soil should be easy to dig using a garden spade driven solely by the inspector's weight. The soil should be darker than the unamended soil below, and particles of added organic matter are likely to be visible. Clay soil that has been saturated and then dried may require jumping on the shovel step to penetrate, but the soil should yield easily when moist. Soil that requires vigorous chipping with the shovel to penetrate probably does not meet the specification.
- The next 4-inch depth of soil should be loose enough to penetrate with the shovel. The soil may be rocky and the loosened depth may vary due to the pattern of scarifying equipment , but some

sections of subsoil in a 1-foot square hole should be loose 4 inches deep into the subsoil (i.e., a total 12-inch depth from the soil surface).

Step 4: Check soil depth in several spots.

- Use a simple “rod penetrometer” to confirm that the soil is uncompacted 12 inches deep at 10 locations per acre, with a minimum of 10 locations on smaller sites. To locate test spots, imagine a line dividing the site (or each acre) in half lengthwise, then divide each half into 5 nearly equal sections. Conduct tests near the middle of each section. Additional test locations are encouraged. The rod penetrometer should enter the soil 12 inches deep, driven solely by the inspector’s weight. Irregular scarification or rocks in the lower layer may require probing a few spots at each location to reach the full depth.

Step 5: Check mulch depth.

- Use a shovel to scrape away and reveal surface mulch thickness. A 2-inch layer of organic material (mulch), such as composted sawdust, wood chips, or ground bark, should be distinguished from the underlying soil on all planting beds.

Final step: Record results on “Field Verification Form” or similar document.

See *Building Soil: Guidelines for Implementing BMP T5.13* cited above and available at www.soilsforsalmon.org or www.buildingsoil.org for additional verification details.

6.2.2.3 Compost

Organic soil amendment, suitable for landscaping and stormwater management, should be a stable, mature compost derived from organic waste materials including yard debris, manures, bio-solids, wood wastes or other organic materials that meet the intent of the organic soil amendment specification. **Compost stability** indicates the level of microbial activity in the compost and is measured by the amount of CO₂ produced over a given period of time by a sample in a closed container.

Unstable compost can render nutrients temporarily unavailable and create objectionable odors.

Determining compost quality

Compost quality can be determined by examining the material and quantitative tests. A simple way to judge compost quality is to smell and examine the finished product, which should have the following characteristics (WORC, 2003):

- Earthy smell that is not sour, sweet or ammonia like.
- Brown to black in color.
- Mixed particle sizes.
- Stable temperature and does not get hot when re-wetted.
- Crumbly texture.

Compost suppliers should supply documentation that their compost meets one or both of the following two standards:

- Material must meet the definition for “composted materials” in WAC 173-350 Section 220. This code is available online at: <http://www.ecy.wa.gov/programs/swfa/facilities/350.html>. A current list of permitted composting facilities in Washington meeting these standards is available at: <http://www.ecy.wa.gov/programs/swfa/compost/>.
- Material may also meet the US Composting Council’s “Seal of Testing Assurance” program, which includes regular testing for maturity, stability, and other standards described below that help ensure optimal plant growth. Many Washington compost facilities are part of this quality assurance program.

Testing standards for compost quality (typically available from compost suppliers) include:

- Organic matter content between 35 and 65 percent as determined by loss of ignition test method (ASTM D 2974 or TMECC 05.07A).
- pH between 6.0 and 8.5.
- Carbon:nitrogen ratio between 15:1 and 25:1 for both turf areas and planting beds (however a C:N ratio of 30:1 to 35:1 is preferred for plantings

6

6.2 Amending construction site soils

6.2.2 design & implementation

composed entirely of Puget Sound lowland native species).

- Maximum electrical conductivity of 5 mmhos/cm or 5 deci-Siemen/meter (dS/m).
- Moisture content range between 35 and 50 percent.
- No viable weed seeds.
- Manufactured inert material (plastic, concrete, ceramics, etc.) less than 1 percent by dry weight
- Metals should not be in excess of limits in the following table from Washington State's compost facility testing requirements in WAC 173-350-220:

Metal	Limit (mg/kg dry weight)
Arsenic	≤ 20 ppm
Cadmium	≤ 10 ppm
Copper	≤ 750 ppm
Lead	≤ 150 ppm
Mercury	≤ 8 ppm
Molybdenum	≤ 9 ppm
Nickel	≤ 210 ppm
Selenium	≤ 18 ppm
Zinc	≤ 1400 ppm

Determining final grade with amended soils

Two factors affect final grade when tilling or ripping and amending or placing amended soils:

- "Fluff factor" from tilling up compacted sub-soils.
- Settling factor as compost amended soils settle in place.

These two factors tend to cancel each other, resulting in a typical combined settling factor of 10-15 percent by volume in compost-amended soils. This means an 8-inch amended soil should be initially placed to a level around 1-1.5 inches higher than the intended final grade to allow for settling. The best way to settle soil in place is to thoroughly wet each lift as applied or amend the soil a month before final landscaping. Mechanical compaction should not be used.

These factors vary widely by soil type, initial compacted conditions, and compost type, so creating a test plot during the project may be the best way to establish fluff

and settling factors. Practically, it's best to place or amend and allow soil to settle (or settle by watering), and then plan for a final addition of up to 1-2 inches of amended soil to meet final grades where critical (such as adjacent to sidewalks and curbs). Another strategy is to design final grades to be slightly mounded to allow for later settling in place. Note: if mounding for later settlement, erosion and sediment controls should be considered to prevent runoff and sediment to adjacent impervious or pervious surfaces and infiltration areas.

Turf areas and drainage

Compost-amended soil (20-25 percent compost by volume) provides improved turf lawn growth, rooting depth, drought resistance, and reduced fertilizer and pesticide demands while also promoting detention, infiltration, and biofiltration of stormwater (McDonald, 1999). As previously noted, sports fields with sand-based turf require specialized soil mixes with less organic and sandy texture to promote free drainage. Lawns on poorly drained sites can become spongy. On those sites a sandy soil mix with 15-20 percent compost by volume provides a firmer surface. A drainage route or subsurface collection system is often recommended for high-traffic turf applications in poorly draining soils.

6.2.2.4 Steep slopes

The Washington State Department of Transportation has been applying compost to condition soils on slopes ranging up to 33 percent since 1992. No stability problems have been observed as a result of the increased water holding capacity of the compost (Chollak, n.d.). Steep slope areas, which have native soils with healthy native landscapes, should be protected from disturbance. On steep slopes where native soils and vegetation are disturbed or removed, soils should be amended and re-vegetated with deep rooting plants to improve slope stability. Compost can be applied to the ground surface without incorporation to improve plant growth and prevent erosion on steep slopes that cannot be accessed by equipment.

**6.2.3 construction sequencing for
protecting construction site soils****6.2.3 Construction sequencing for
protecting construction site soils**

Soil protection and restoration begins with the initial site survey and continues throughout the project. Following these steps at each phase will save time and money, and result in a higher-value final landscape on site as well as better stormwater performance (adapted from *When to Amend: Construction Sequencing for Soil Protection and Restoration*, McDonald 2008, available at www.buildingsoil.org/tools/When_to_Amend.pdf).

Design phase

- Survey site soils and vegetation to determine where good quality existing soil and vegetation may be candidate areas for protection.
- Identify vegetation and soil protection areas, and verify they work with the site access and development program.
- Identify areas to be graded and most cost-effective options for stockpiling, amending, or importing topsoil. Calculate compost amendment, topsoil, and mulch quantities needed for each area.
- Record the above information on a SMP.
- Review construction schedule, identifying how the soil protection and restoration practices will be incorporated at each phase.
- Involve entire design team in reviewing the SMP, and communicate it to construction managers and contractors.

Land clearing and grading phase

- Fence all vegetation and soil protection areas prior to first disturbance, and communicate those areas and the SMP to clearing and grading operators. Root zones of trees that may extend into the grading zone should be protected or cut rather than ripped during grading.
- Land-clearing debris can often be chipped on-site and reused immediately as erosion-control cover, or stockpiled for reuse as mulch at end of project.
- Stockpile topsoil to be reused with a breathable cover, such as wood chips or landscape fabric.
- If amended, topsoils will be placed at end of project, grade 8-12 inches below finish grade to allow for placing the topsoil.

Construction phase

- Ensure erosion and sediment control BMPs are in place before and revised after grading to protect construction activities. Compost based BMPs (2-inch compost “blankets” for surface, and compost berms or socks for perimeter controls) give a two-for-one benefit because the compost can be reused as soil amendment at the end of the project.
- Lay out roads and driveways immediately after grading and place rock bases for them as soon as possible. Then keep as much construction traffic as possible on the road base, and off open soils. This will improve erosion compliance, reduce soil compaction, and increase site safety by keeping rolling equipment on a firm base.
- Maintain vegetation and soil protection area barriers and temporary tree root zone protection BMPs throughout construction and ensure that all contractors understand their importance.

End of construction, soil prep before planting

- Ensure vegetation and soil protection barriers stay up until end of project.
- Disturbed or graded soil areas that have received vehicle traffic will need to be de-compacted to a minimum 12-inch depth. This can be done with a cat-mounted ripper or with bucket-mounted ripping teeth.
- Amend all disturbed areas with compost at least 8 inches deep by tilling, ripping, or mixing with a bucket loader. Alternatively, place compost-amended stockpiled topsoil or import a compost-amended topsoil. It is good practice to scarify or mix soil/compost several inches into the underlying subsoil to enhance infiltration and root penetration. Compost from erosion BMPs (compost blankets, berms, or socks) can be reused at this point if immediately followed by planting and mulching so there is no lapse in TESC.
- Amended topsoil can be placed as soon as building exterior work is complete, if contractors understand that vehicles must stay on roads and driveway pads. Compost, soil blends provide good ongoing erosion protection.

6

6.2 Amending construction site soils

6.2.4 maintenance / 6.2.5 performance

- Avoid tilling through tree roots – instead use shallow amendment and mulching.
- Final prep for turf areas will include raking rocks, rolling, and possibly placing 1-2 inches of sandy loam topsoil before seeding or sodding.
- Plan for amended soil to settle by placing amended soil slightly higher than desired final grade, or retain or import a smaller amount of amended topsoil to meet final grades adjacent to hardscape such as sidewalks.
- Keep compost, topsoil, and mulch delivery tickets so inspector can verify that quantities and products used match those calculated in the SMP at start of project.

After planting and end of project phase

- Remove protection area barriers, including sediment fences, filter socks, and curb and stormwater inlet barriers. Evaluate trees for stress and need for remediation, such as pruning, root-feeding, mulching etc. Plan to have an arborist on-site.
- Mulch all planting beds where soil has been amended and re-planted with 2-3 inches of arborist wood chip mulch.
- Protect amended/restored soils from equipment-caused compaction, using steel plates or other BMPs if equipment access is unavoidable across amended soils.
- Communicate a landscape management plan to property owners that includes: onsite reuse of organics (e.g., mulch leaves, mulch-mow grass clippings) to maintain soil health; avoiding pesticide use; and minimal organic-based fertilization.

6.2.4 Maintenance

- Incorporate soil amendments at the end of the site development process.
- Protect amended areas from excessive foot traffic and equipment to prevent compaction and erosion.
- Plant and mulch areas immediately after amending and settling soil to stabilize site as soon as possible.

- Landscape management plans should continually renew organic levels through mulch-mowing (grasscycling) on turf areas, allowing leaf-fall to remain on beds, and/or replenishing mulch layers every 1-2 years.
- Minimize or eliminate use of pesticides and fertilizers. Landscape management personnel should be trained to minimize chemical inputs, use non-toxic alternatives, and manage the landscape areas to minimize erosion, recognize soil and plant health problems, and optimize water storage and soil permeability.

6.2.5 Performance

The surface bulk density of construction site soils generally range from 1.5 - 2.0 gm/cc (CWP, 2000a). At 1.6 - 1.7 gm/cc, plant roots cannot penetrate soil and oxygen content, biological activity, nutrient uptake, porosity, and water holding capacity are severely degraded (CWP, 2000a and Balousek, 2003). Tilling alone has limited effect for reducing the bulk density and enhancing compacted soil. A survey of research examining techniques to reverse soil compaction by Schueler found that tilling reduced bulk density by 0.00-0.15 gm/cc. In contrast, tilling with the addition of compost amendment decreased bulk density by 0.25-0.35 gm/cc (CWP, 2000a).

Balousek (2003) cleared, graded, and compacted test plots with silt loam soil to simulate construction site conditions and then applied combinations of deep tillage (single shank ripper behind bulldozer lowered into soil 90 cm) and chisel plow (four shanks behind a tractor lowered 30 cm into soil). Compost was tilled into selected plow treatments and simulated storms were applied to the plots. The deep-tilled only plots increased runoff volume compared to the control (no grading or compaction), and the combined chisel plow and deep-tilled treatment with no compost reduced runoff volume by 36-53 percent. With compost added to the combined plow and till treatment, runoff volume was reduced by 74-91 percent.

“Research plots at the University of Washington, prepared with various amounts and types of compost mixed with till soil and planted with turf, generated 53-70 percent less runoff volume than from the unamended control plots.”

Research plots at the University of Washington, prepared with various amounts and types of compost mixed with till soil and planted with turf, generated 53-70 percent less runoff volume than from the unamended control plots. The greatest attenuation was observed in treatments with a ratio of 2 parts soil to 1 part fine, well-aged compost. The study indicates that using compost to amend lawn on till soils can “significantly enhance the ability of the lawn to infiltrate, store and release water as baseflow” (Kolsti, Burges, and Jensen, 1995).

THIS PAGE
INTENTIONALLY
LEFT BLANK

6.3 Permeable Pavement

Pavement for vehicular and pedestrian travel occupies roughly twice the space of buildings. While essential for the movement of people, goods and services, vehicular pavement generates significant levels of heavy metals and most hydrocarbon pollutants in stormwater (Ferguson, 2005). The concentration of pollutants (specifically metals and hydrocarbons) in vehicular pavement surface flow, in general, increases with traffic intensity (Ferguson, 2005 and Colandini et al., 1995).

Both pedestrian and vehicular pavements also contribute to increased peak flow, flow durations, and associated physical habitat degradation of streams and wetlands. Effective management of stormwater quality and quantity from paved surfaces is, therefore, critical for improving fresh and marine water conditions in Puget Sound.

Permeable paving surfaces are an important integrated management practice within the LID approach and can be designed to accommodate pedestrian, bicycle, and auto traffic while allowing infiltration, treatment, and storage of stormwater. The general categories of permeable paving systems include:

- Porous hot or warm-mix asphalt pavement, a flexible pavement similar to standard asphalt that uses a bituminous binder to adhere aggregate together. However, the fine material (sand and finer) is reduced or eliminated and, as a result, voids form between the aggregate in the pavement surface and allow water to infiltrate.
- Pervious Portland cement concrete, a rigid pavement similar to conventional concrete that uses a cementitious material to bind aggregate together. However, the fine aggregate (sand) component is reduced or eliminated in the gradation and, as a result, voids form between the aggregate in the pavement surface and allow water to infiltrate.
- Permeable interlocking concrete pavements (PICP) and aggregate pavers. PICPs are solid, precast, manufactured modular units. The solid pavers are (impervious), high-strength Portland

cement concrete manufactured with specialized production equipment. Pavements constructed with these units create joints that are filled with permeable aggregates and installed on an open-graded aggregate bedding course. Aggregate pavers (sometime called pervious pavers) are a different class of pavers from PICP. These include modular precast paving units made with similar-sized aggregates bound together with Portland cement concrete with high-strength epoxy or other adhesives. Like PICP, the joints or openings in the units are filled with open-graded aggregate and placed on an open-graded aggregate bedding course. Aggregate pavers are intended for pedestrian use only.

- Grid systems made of concrete or plastic. Concrete units are precast in a manufacturing facility, packaged and shipped to the site for installation. Plastic grids typically are delivered to the site in rolls or sections. The openings in both grid types are filled with topsoil and grass or permeable aggregate. Plastic grid sections connect together and are pinned into a dense-graded base, or are eventually held in place by the grass root structure. Both systems can be installed on an open-graded aggregate base as well as a dense-graded aggregate base.

Nomenclature for permeable paving systems varies among designers, installers and geographic regions. For this manual, permeable pavement is used to describe the general category of pavements that are designed to allow infiltration through the pavement section. The following terms are used throughout this manual and represent the major categories of permeable pavements that carry vehicular as well as pedestrian traffic: pervious concrete, porous asphalt, permeable interlocking concrete pavements, and concrete and plastic grid pavements.

6

6.3 Permeable Pavement

6.3.1 applications

6.3.1 Applications

Typical applications for permeable paving include industrial and commercial parking lots, sidewalks, pedestrian and bike trails, driveways, residential access and collector roads, and emergency and facility maintenance roads. Grid pavers are not intended for streets but are often used for emergency access lanes and intermittently used (overflow) parking areas. All other types of permeable paving can withstand loads from the number of trucks associated with residential collector roads. Specialized engineering expertise is required for designs for heavy loads.

Thoroughfares, highways, and other roads that combine high vehicle loads and high speed traffic are generally not considered appropriate for permeable pavements. However, porous asphalt has proven structurally sound and remained permeable in a few arterial and highway applications (Hossain et al, 1992) and pervious concrete and permeable interlocking concrete pavement have been successfully used in industrial settings with low speeds and high vehicle loads.

The only porous surface designed and commonly applied for high-speed use is an asphalt open-graded friction course (OGFC). This is applied as a thin overlay on impervious asphalt pavement to reduce road noise and hydroplaning. OGFC has shown some benefits in reducing highway pollutants. However, it will not be covered in this document since this surface has a limited ability to detain and treat stormwater as well as having a short design life.



figure 6.3.1

All roads, sidewalks and driveways are pervious concrete in this Puget Sound residential subdivision.
Source: Curtis Hinman



figure 6.3.2

Permeable interlocking concrete pavers applied in the commercial setting.
Source: Abbotsford Concrete Products

table 6.3.1 Typical permeable pavement applications

Application	Residential walk/patio	Residential driveway	Commercial pedestrian plaza	Emergency access lane or overflow parking lot	Parking lot or travel lanes	Residential street or collector	High speed highway (>35mph)
Porous Asphalt	Yes	Yes	Yes	Yes	Yes	Yes	Limited to-date
Pervious Concrete	Yes	Yes	Yes	Yes	Yes	Yes	No
PICP	Yes	Yes	Yes	Yes	Yes	Yes	No
Grid Pavements	Yes	Yes	Yes	Yes	No	No	No

Permeable paving systems have been designed with aggregate storage to function as infiltration facilities with low subgrade infiltration rates (as low as 0.003 inch/hour) in the Puget Sound region. When water is not introduced from adjacent areas, these systems have a lower ratio of contribution to infiltration area (e.g., 1 to 1) than conventional infiltration pond facilities and are less likely to have excessive hydraulic loading. Using the 0.003 inch/hour soil infiltration rate as an example, a 24-hour storm and a 48-hour drain-down time (typical outflow design) yields over 0.2 in. of infiltrated water. This suggests that even on poorly draining soils, permeable pavements have a role in reducing runoff volumes and pollutants.

“Initial research indicates that properly designed and maintained permeable pavements can virtually eliminate surface flows for low-intensity storms common in the Pacific Northwest, store or significantly attenuate subsurface flows (depending on underlying soil and aggregate storage design), and provide water quality treatment for nutrients, metals and hydrocarbons (see Section 6.3.4: Performance for additional information).”

Permeable pavement should not be used (unless additional engineering analysis and design is conducted) where:

- Excessive sediment is deposited on the surface (e.g., construction and landscaping material yards).
- Steep erosion prone areas are upslope of the permeable surface and will likely deliver sediment and clog pavement on a regular basis, and where maintenance is not conducted regularly.
- Concentrated pollutant spills are possible, such as gas stations, truck stops and industrial chemical storage sites, and where infiltration will result in transport of pollutants to deeper soil or groundwater.
- Seasonally high groundwater is within 1 foot of the bottom of the aggregate base (interface of the subgrade and aggregate base).
- Fill soils, when saturated, cannot be adequately stabilized.
- Sites receive regular, heavy applications of sand (such as weekly) for maintaining traction during winter.
- Steep slopes where water within the aggregate

6

6.3 Permeable Pavement

6.3.1 applications

base layer or at the subgrade surface cannot be controlled by detention structures (e.g., check dams) and may cause erosion and structural failure, or where surface runoff velocities may preclude adequate infiltration at the pavement surface. Note that permeable pavement has been used successfully on slopes up to 10 percent with subsurface detention structures (personal communication Chris Webb, 2005) and at 8 percent slopes without subsurface detention (personal communication Robin Kirschbaum, 2011).

Slope restrictions result primarily from flow control concerns and to a lesser degree structural limitations of the permeable paving. Gradient increases surface and subsurface flow velocities and reduces infiltration capability and storage capacity of the pavement system. Detention structures placed on the subgrade and below the pavement can be used to detain subsurface flow and increase infiltration and maximum slope recommendation (see Section 6.3.2.1 for detention structure details). In general, detention structures should be considered for permeable pavement on slopes ≥ 3 percent. See Chapter 7: Modeling for the flow control reduction associated with permeable paving and subgrade detention structures. All permeable pavement surfaces should have a minimum slope of 1-2 percent to allow for surface overflow in extreme rainfall. General recommendations for maximum slopes for permeable pavement:

- Porous asphalt: 5 percent.
- Pervious concrete: 12 percent.
- Permeable interlocking concrete pavement: 12 percent (Smith, 2011).
- Concrete and plastic grid systems: maximum slope recommendations vary by manufacturer and generally range from 6-12 percent (primarily a traction rather than infiltration or structural limitation). Contact the manufacturer or local supplier for specific product recommendations.

Permeable pavements covered in this manual

Many individual products with specific design requirements are available and cannot all be examined in this manual. To present a representative sample of widely applied products, this section will examine the design, installation, maintenance, and performance of porous hot or warm-mix asphalt, pervious Portland cement concrete, permeable interlocking concrete pavement, and a plastic grid system.

Examples of permeable pavement systems

Permeable paving materials and applications designed for infiltrating stormwater have evolved over the past four decades in the U.S. and are now used in a wide variety of applications. The following images provide examples of recent and older applications.



figure 6.3.3

Pervious concrete is used for many of the paved surfaces at this athletic complex in Lacey, WA.
Source: Curtis Hinman



figure 6.3.4

Permeable interlocking concrete pavers used for the main entrance to the Mukulteo Lighthouse State Park.
Source: Mutual Materials

6

6.3 Permeable Pavement

6.3.1 applications

figure 6.3.5

Plastic grid system
(Gravelpave) Point Defiance
Zoo Tacoma, WA.
*Source: Photo by
Curtis Hinman*



6.3.2 Design and Construction

Mix design, handling and installation procedures for permeable paving systems are different from conventional pavement. For successful application of any permeable paving system, four basic guidelines must be followed:

“For successful application of any permeable paving system, four general guidelines must be followed:

- **Conduct adequate site analysis and appropriate site application.**
- **Follow correct design specifications.**
- **Use qualified contractors or preferably certified contractors where certification program exists.**
- **Control erosion and sediment during construction and throughout service life.”**

1. Adequate site analysis and appropriate site application

As with all LID IMPs, adequate site analysis and the selection of the proper practice and materials within the context of the physical setting and development needs are critical. Important considerations include: vehicle use; soil type and permeability; groundwater; topography and the potential for sediment inputs to the permeable pavement; surrounding pollution generating land uses; surrounding vegetation; and maintenance needs.

2. Correct design specifications

There are many design needs common to most permeable pavements and some unique aspects to each system. Industry associations can assist with design and specification guidance. Common and system-specific design needs are provided in detail later in this manual. In brief, they include proper site preparation, correct aggregate base, pavement surface mix design, geotextile separation layer (if included), and under-drain design (if included). All are essential for adequate infiltration, storage, and release of storm flows as well as structural integrity. Construction specifications should include contractors on the job site holding certificates from industry programs

on installing their systems. The pervious concrete and permeable interlocking concrete pavement industry associations offer such education programs for contractors. Specifications should also include contractor experience with projects of similar size and scope.

3. Qualified manufacturers, installation contractors and suppliers

Material manufacturers must have experience with producing proper mix designs for pervious concrete or porous asphalt and make materials that comply to national standards. Permeable interlocking concrete pavement and other factory produced materials should conform to national product standards. Installation contractors must be adequately trained, have substantial and successful experience with the pavement product, and adhere to material specifications for proprietary systems. Installation contractors should provide information showing successful application of permeable pavements for past projects and recommended certification, if available, for the specific type of permeable pavement. Suppliers must have experience with producing proper mix designs for pervious Portland cement concrete or porous hot-mix asphalt. Substituting inappropriate materials or installation techniques will likely result in structural or hydrologic performance problems or failures.

4. Sediment and erosion control during construction and long-term

Erosion and introduction of sediment from surrounding land uses should be strictly controlled during and after construction to reduce clogging of the void spaces in the subgrade, base material, and permeable surface. Muddy construction equipment should not be allowed on the base material or pavement, sediment laden runoff should be directed to treatment areas (e.g., settling ponds and swales), and exposed soil should be mulched, planted, and otherwise stabilized as soon as possible. Construction sequencing for proper installation and minimizing erosion and sediment

6

6.3 Permeable Pavement

6.3.2 design & construction

inputs is critical for project success. Long-term operation and maintenance plans that consider the physical setting, timing, and equipment needs should be developed during the design phase. Provide signage identifying permeable pavement installations and inform adjacent property owners of permeable installations and necessary care for long-term performance. See Chapter 5: Precision Site Preparation and Construction and Section 5.3.3 Permeable pavement for details on construction procedures.

The above guidelines are mandatory for the installation of permeable paving systems. Poor quality installations are most often attributed to not following the above four guidelines and structural or flow management problems or failures are likely without qualified contractors and correct application of specifications.

6.3.2.1 Common components, design, and construction criteria for permeable pavement

The following provides the purpose and guidelines for the common components of permeable paving systems. Design details for specific permeable paving system components are included in Section 6.3.2.2: Types of Permeable Pavement.

Contributing area

Minimizing the amount of run-on from adjacent surfaces is preferred to prevent clogging and maximize the long-term performance of the pavement system. Introducing stormwater discharge from other impervious surfaces may be acceptable with careful consideration of the following minimum conditions: 1) sediment is not introduced to the pavement surface or subgrade; and 2) the additional flows do not exceed the long-term infiltration capability of the pavement surface or subgrade.

Subgrade

Careful attention to subgrade preparation during construction is required to balance the needs for structural support while maintaining infiltration capacity. For all permeable pavements, relative uniformity of subgrade conditions is necessary to prevent differential settling or other stress across the system.

In general, the requirement for subgrade strength beneath rigid pavement (pervious concrete) is less than for flexible pavements. The structural performance of flexible permeable pavement systems rely on the proper design and construction of the aggregate base to provide structural support on subgrades with less compaction and increased soil moisture.

On sites where the topsoil is removed and native sub-soil exposed, no compaction may be required for adequate structural support while protection of the subgrade from compaction is necessary to retain infiltration capacity. For applications with heavy truck traffic, some soil subgrade compaction may be necessary for structural support. The effect of compaction on subgrade permeability will vary significantly depending on soil type. For example, the permeability of a coarser textured sand may be affected minimally while the permeability of finer textured soils will likely be significantly degraded for a given compaction effort. Effects of compaction on soil permeability can be assessed by conducting laboratory Proctor density tests on subgrade soils from the proposed permeable pavement site. Soils in test areas can be compacted to various density levels through field measurements and the resulting permeability measured using ASTM test methods. See Determining subgrade infiltration rates under Section 6.3.2.1 for more detail on test procedures.

Two predominant guidelines are currently used for subgrade compaction of permeable pavement systems: firm and unyielding (qualitative) and 90-92 percent standard proctor (quantitative). Consult with the permitting jurisdiction and qualified engineer for applicable guidelines. To properly prepare and maintain infiltration capacity and structural support on permeable pavement subgrades, use the following procedures:

- A qualified engineer should analyze soil conditions for infiltration capability at anticipated compaction and load bearing capacity, given anticipated soil moisture conditions.
- During and after grading, the existing subgrade

should not be compacted more than the recommended compaction effort by excessive construction equipment traffic or material stockpiling. The following guidelines should be used to prevent excessive compaction and maintain infiltration capacity of the subgrade:

- » Final grading should be completed by machinery operating on a preliminary subgrade that is at least 12 inches higher than final grade or structures to distribute equipment load (e.g., steel plates or aggregate base material). Final excavation then proceeds as machinery is pulling back and traveling on preliminary grade as final grade is excavated.
- » To prevent compaction when installing the aggregate base, the following steps (back-dumping) should be followed: 1) the aggregate base is dumped onto the subgrade from the edge of the installation and aggregate is then pushed out onto the subgrade; 2) trucks then dump subsequent loads from on top of the aggregate base as the installation progresses.
- » Avoid subgrade preparation during wet periods (soil compaction increases significantly if soil is wet).
- » If machinery must access the final grade, limit the access to a specific travel way that can be tilled before application of the base aggregate or place heavy steel plates on subgrade and limit traffic to the protective cover.
- » NOTE: allowing heavy machinery on permeable paving subgrades during wet or saturated conditions will result in deep compaction (often 3 feet) and cannot be compensated for by shallow tilling or ripping soil (Balousek, 2003).
- If using the pavement system for retention in parking areas, excavate the subgrade level to allow even distribution of water through the aggregate base and maximize infiltration across the entire parking area (Cahill, Adams and Marm

2003, 2005).

- Immediately before placing base aggregate and pavement, remove any accumulation of fine material (if present) from erosion with light equipment and scarify soil to a minimum depth of 6 inches to prevent sealing of the subgrade surface.

Sub-surface detention structures

As permeable pavement subgrade slopes increase, storage and infiltration capacity decrease and flow velocities increase. To increase infiltration, improve flow attenuation, and reduce structural problems associated with subgrade erosion on slopes, use the following detention structures placed on the subgrade and below the pavement surface:

- Periodic impermeable check dams with an overflow drain invert placed at the maximum ponding depth. The distance between berms will vary depending on slope, flow control goals, and cost. (See figure 6.3.6.)
- Gravel trenches with overflow drain invert placed at the maximum ponding depth. The distance between trenches will vary depending on slope, flow control goals, and cost.
- Excavate the subgrade with level steps. The step length will vary depending on slope, flow control goals, and cost. Excavating level steps is most applicable for parking lots where the pavement surface is also stepped. While the subgrade is excavated level, the pavement surface should maintain a minimal slope of 1-2 percent.

6

6.3 Permeable Pavement

6.3.2 design & construction

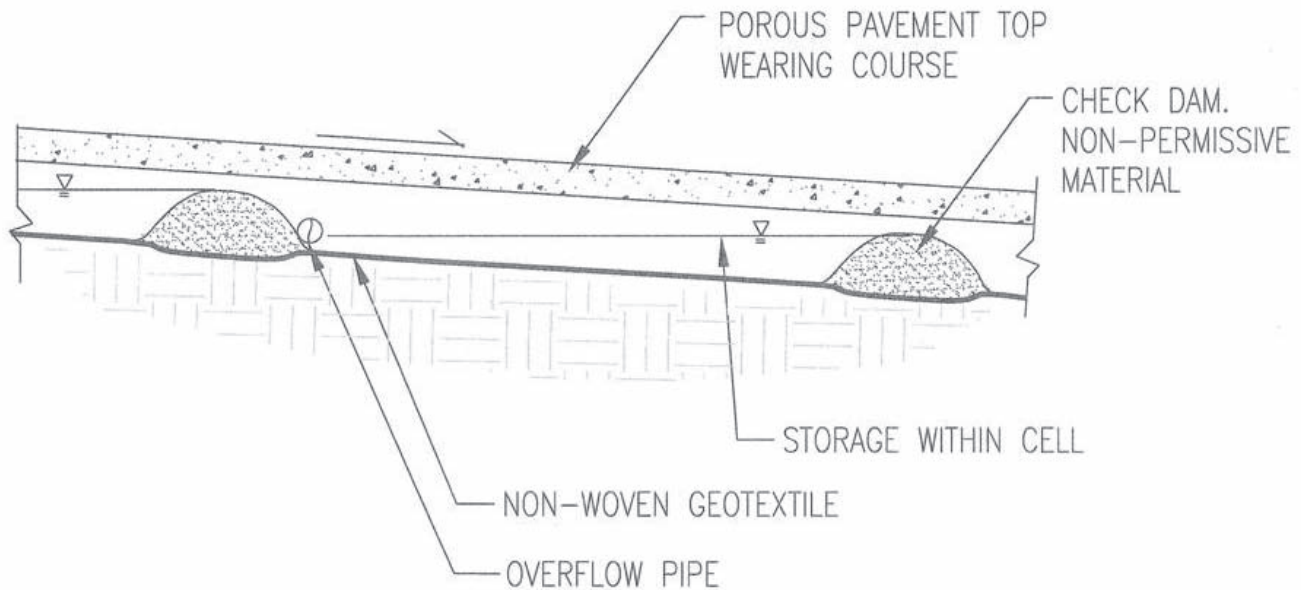

figure 6.3.6

Impermeable check dams to retain subsurface flow on permeable pavement installations with sloped subgrade.

Source: SVR

Storage reservoir/aggregate base

The open-graded aggregate base provides: 1) a stable base that distributes vehicular loads from the pavement to the subgrade; 2) a highly permeable layer to disperse water downward and laterally to the underlying soil; and 3) a temporary reservoir that stores water prior to infiltration into the underlying soil or collection in under-drains for conveyance (Washington State Department of Transportation [WSDOT], 2003).

Aggregate base material is often composed of larger aggregate (1.5-2.5 inches). Smaller stone (leveling or choker course) may be used between the larger stone and the pavement depending on pavement type, working surface required to place the pavement, and base aggregate size (see sections below on specific pavement type and leveling or choker course guidelines). Typical void space in base layers range from 20-40 percent (WSDOT, 2003 and Cahill, Adams and Marm, 2003). Depending on the target flow control standard, groundwater and underlying soil type, retention or detention requirements can be partially or entirely met in the aggregate base. Aggregate base

depths of 6-36 inches are common depending on pavement type, structural design, and storage needs.

Flexible pavements (e.g., porous asphalt and permeable pavers) require properly designed aggregate base material for structural stability. Rigid pavements (pervious concrete) do not require an aggregate base for structural stability; however, a minimum depth of 6 inches is recommended for stormwater storage and providing a uniform surface for applying pervious concrete.

Increasing aggregate base depth for stormwater storage provides the additional benefit of increasing the strength of the overall pavement section by isolating underlying soil movement and imperfections that may otherwise be transmitted to the wearing course (Cahill, Adams and Marm 2003). For more information on aggregate base material and structural support, see Section 6.3.2.1: Infiltration and subgrade structural support and Section 6.3.2.2: Types of permeable pavement for aggregate base recommendations by specific pavement type.

Geotextile and geogrids (optional)

Geotextiles between the subgrade and aggregate base are not required or necessary for many soil types. However, for all permeable pavements, geotextile is recommended on the side slopes of the open graded base perimeter next to the soil subgrade if concrete curbs or impermeable liners are not provided that extend the full depth of the base/sub-base. AASHTO M-288 (AASHTO 2010) provides guidance for selection of geotextiles specifically for separation and drainage applications.

Geotextiles and geogrids are generally recommended:

- As a filter layer to prevent clogging of infiltration surfaces.
- For soil types with poor structural stability to prevent downward movement of the aggregate base into the subgrade (geotextiles or geogrids).

Clogging of the subgrade soil under permeable pavement systems could occur by fines from surface stormwater flow moving downward through the pavement section or from fines associated with the base aggregate washing off the rock and moving downward to the subgrade surface. Clogging of the base aggregate by the upward migration of fines into the aggregate has also been observed. The probability of clogging from surface flow should be extremely low, given current research that shows accumulation of fines predominantly in the upper few centimeters of permeable pavement sections. Movement of fines from the aggregate base rock is likely if the aggregate base specification for the pavement system allows for excessive fines. The third process (upward movement of fines into the base aggregate) requires capillary tension for water (and sediment) to move upward into the base material. Base aggregate for permeable paving systems are open graded (20-40 percent voids are common) which minimizes the capillary tension necessary for upward movement of materials.

Currently, the rate and subsequent risk of soil subgrade clogging from fines is not well understood. While permeable pavement surfaces trap sediment prior to entering the base and soil subgrade, there is no

research or forensic exploration of existing permeable pavement projects demonstrating the extent of fines accumulating on soil subgrades.

For applications on fine-grained weak soil types, geotextile or geogrid may be necessary to minimize downward movement of base aggregate. Geotextiles provide tensile strength as the subgrade attempts to deform under load and the fabric is placed in tension, thereby improving load bearing of the pavement section (Fergusen, 2005).

If geotextile is used between the subgrade and base aggregate:

- Use geotextile recommended by the manufacturer's specifications and recommendations of the geotechnical engineer for the given subgrade soil type and base aggregate.
- Extend the fabric up the sides of the excavation in all cases. This is especially important if the base is adjacent to conventional paving surfaces. The fabric can help prevent migration of fines from dense-graded base material and soil subgrade to the open graded base. Geotextile is not required on the sides if concrete curbs extend the full depth of the base/sub-base.
- Overlap adjacent strips of fabric at least 24 inches. Leave enough fabric to completely wrap over small installations (e.g., sidewalks) or the edge of larger installations adequately to prevent sediment inputs from adjacent disturbed areas. Secure fabric outside of storage bed. (See figure 6.3.7.)
- Following placement of base aggregate and again after placement of the pavement, the filter fabric (if used) should be folded over placements and secured to protect installation from sediment inputs. Excess filter fabric should not be trimmed until site is fully stabilized (U.S. Army Corps of Engineers, 2003).

6

6.3 Permeable Pavement

6.3.2 design & construction



figure 6.3.7

Filter fabric placed under this pervious concrete sidewalk is left long, wrapped over the pavement and secured to protect the installation during construction.
Source: Curtis Hinman

Membrane liners and barriers

Membrane liners on sidewalks of permeable pavement installations are recommended to:

- Reduce sidewall soil movement and degradation of subgrade infiltration capability.
- Protect adjacent densely graded subgrade material from migrating into the more open graded aggregate base of the permeable pavement.

Thirty mil PVC membranes are typical and should extend from the top of the aggregate base and 12 inches onto the bottom of the subgrade.

Under-Drains (optional)

One or more under-drains may be installed at the bottom of a permeable pavement system if the infiltration capacity of the subgrade soil is not adequate to:

protect the pavement wearing course from prolonged saturation that reduce infiltration capability; protect specific subgrade soil types from excessive periods of saturation that may lead to structural weakness; and protect the pavement and subgrade from freeze-thaw cycles. Under-drains without orifice or control structures will reduce infiltration to the subgrade and flow reduction, which can be predicted by modeling. See Chapter 7 for properly representing under-drains in WWHM or MGSFlood.

Under-drains should include an orifice. With an orifice, the permeable pavement installation will operate as an underground detention system. Recommendations for permeable pavement under-drains include:

- Under-drain flows should be conveyed to an approved discharge point.
- At a minimum, slotted or perforated, thick-walled plastic pipe with a minimum diameter of 6 inches should be used. Slots or perforations can be oriented up or down for installation.
- An appropriate cover depth and pipe material should be used that considers vehicle loads.
- To prevent clogging, the minimum orifice diameter should be 0.5 inch and maintenance activities should include regular inspection. Review local jurisdiction requirements for local minimum orifice diameter for below ground structures.

Elevated drains (optional overflow)

An overflow or elevated drain may be installed in the aggregate base of a permeable pavement system if the infiltration capacity of the subgrade soil is not adequate to protect the pavement wearing course from saturation. An elevated drain can also be used to create retention beneath the elevated drain invert if the subgrade analysis determines that the subgrade can provide adequate structural support, given the duration of saturated conditions. Facility overflow can be provided by subsurface slotted drain pipe(s) or by lateral flow through the storage reservoir to a surface or subsurface conveyance. Flows must be routed to an approved discharge point. (See figure 6.3.8.)

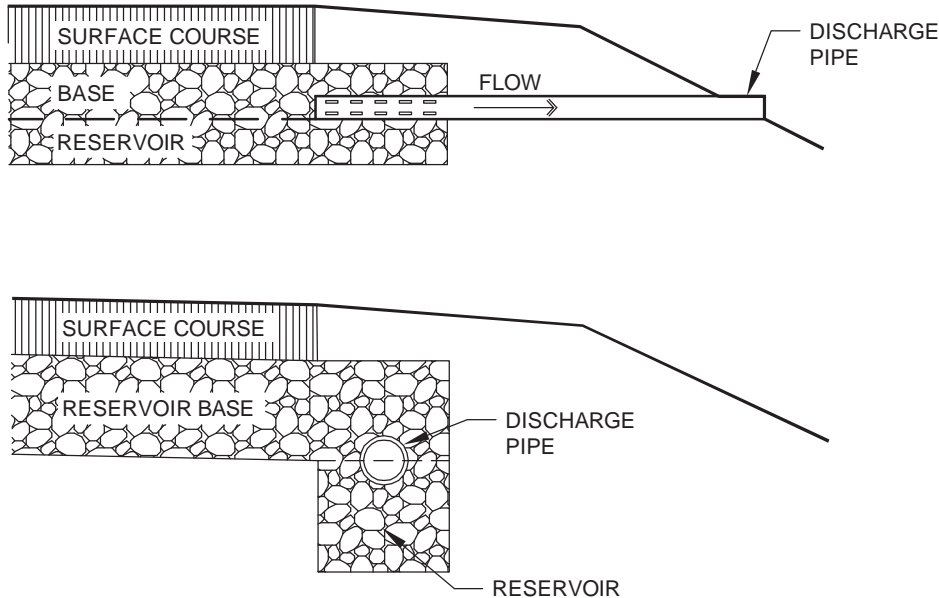

figure 6.3.8

Elevated drain designs (optional overflow) for permeable pavement aggregate base/reservoir. Source: Adopted from Ferguson, 2005

Recommendations for elevated drain design include the following:

- The maximum elevation of the overflow invert from the subgrade should drain water in the base aggregate before reaching the bottom of the permeable pavement wearing course and prevent saturation of the pavement.
- If site constraints necessitate an overflow pipe in an area subject to traffic or other loading, cover depth and pipe material should be designed to accommodate those loads.
- The pipe diameter and spacing for slotted overflow pipes will depend on the hydraulic capacity required. For a sloped subgrade, at least one overflow pipe should be installed at the downslope end of facility.
- Observation and cleanout ports should be used to determine whether the overflow is dewatering properly and allows access for back flushing.
- Overflows shall be designed to convey excess flow to approved discharge point.

Flow entrance

When designed to take runoff from other catchment areas, permeable pavement areas must be protected from sedimentation, which can cause clogging and degraded facility performance. Acceptable flow entrance methods include sheet flow to the permeable pavement surface or subsurface delivery to the storage reservoir via pipes (e.g., for roof drainage). Accepted pre-treatment for sediment removal (e.g., filter strip for surface flow and catch-basin for subsurface delivery) should be included for any runoff to permeable pavement systems.

Backup infiltration

Backup infiltration can be designed into any permeable pavement system. Typical backup systems include: aggregate areas along roads; parking lot medians and perimeters; and surface drains that are connected to the aggregate reservoir/base layer under the permeable pavement. (See figure 6.3.9) The permeable pavement surface is then sloped gradually to the overflow or backup infiltration area (1-2 percent maximum slope

6

6.3 Permeable Pavement

6.3.2 design & construction

figure 6.3.9

The aggregate median provides a connection and overflow protection from the pavement surface to the aggregate base.

Source: Adopted from Cahill

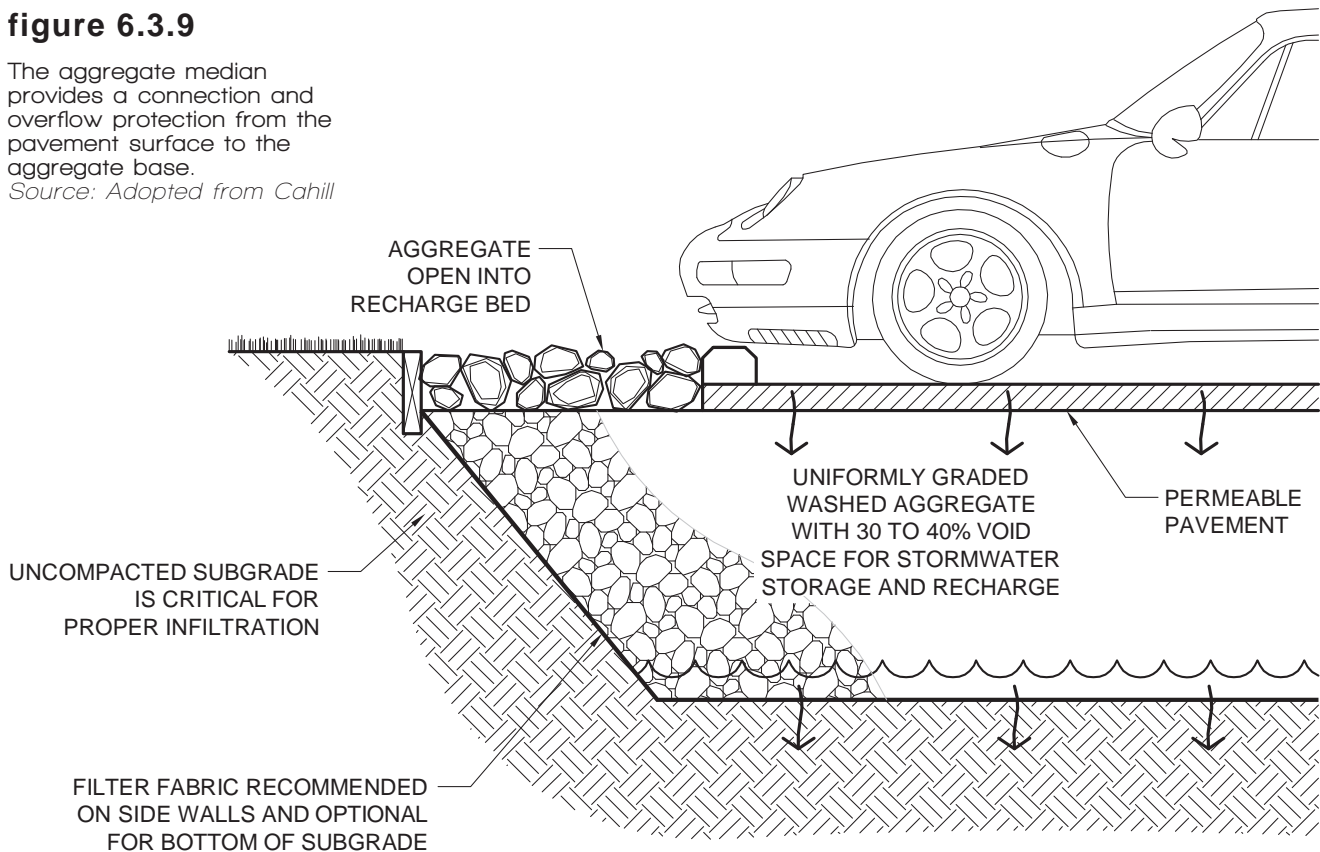

recommended).

Wearing course or surface layer

The wearing course provides support (in conjunction with the aggregate base) for the designed traffic loads while maintaining adequate porosity for storm flow infiltration. In general, permeable top courses have very high initial infiltration rates with various asphalt and concrete research reporting 28-1750 inches per hour when new. Various rates of clogging have been observed in wearing courses and should be anticipated and planned for in the system design. Permeable paving systems allow infiltration of storm flows; however, to prevent freeze-thaw damage and retain infiltration capability, the wearing course should not become saturated from excessive water volume stored in the aggregate base layer.

Water quality treatment

Currently, no water quality treatment credit through Ecology is associated with stormwater passing through a standard permeable pavement wearing course or the aggregate base. However, enhanced treatment can be attained using one of the following design approaches:

- Infiltrate 91 percent of the annual stormwater runoff file into subgrade soils that have a cation exchange capacity of ≥ 5 milliequivalents/100 grams dry soil, minimum organic matter content of 0.5 percent and a maximum infiltration rate of 12 inches per hour (short-term or measured rate). The soil must have the above characteristics for a minimum depth of 18 inches.
- Design a treatment layer into the aggregate base that has the characteristics described above for subgrade soils.

Freeze-thaw considerations

Properly designed permeable paving installations have performed well in the Midwest and Northeast U.S. where freeze-thaw cycles are severe (Adams 2003 and Wei 1986). Research shows that bases under pervious concrete (Kevern 2009), porous asphalt (Backstrom 2000) and permeable interlocking concrete pavement (Attarian 2010) do not heave during the winter and do not require thickening of the aggregate base.

Infiltration and subgrade structural support

Water, and particularly prolonged saturated conditions, can weaken most subgrade soils (Ferguson, 2005). For flexible permeable pavements, reduced compaction of the subgrade and the introduction of water to the subgrade can be compensated for by proper structural and hydrologic design, given the subgrade soil type and, importantly, by selecting proper aggregate base materials and increasing the aggregate base depth. A properly designed aggregate base distributes vehicle load and subgrade bearing area (see figure 6.3.10). The primary method for strengthening rigid pervious concrete is to increase the thickness of the pavement.

Increasing the aggregate base depth in permeable pavement systems provides the added benefit of increasing stormwater storage capacity, which can be particularly beneficial on subgrades with low permeability. Additionally, open graded stone may remain more stable in saturated conditions than densely graded road bases because the clean stone has less aggregate fines and, as a result, reduced pore pressures during saturated conditions (Smith, 2011). However, the same author also references several sources that indicate reduced structural capacity of open-graded bases compared to dense-graded bases under stresses from vehicular loads. Industry association literature should be referenced for base thicknesses for structural support.

Determining subgrade infiltration rates

A preliminary site assessment is necessary for designing LID projects with permeable pavement and other distributed stormwater management practices integrated into the project layout. Preliminary site assessment includes surface and subsurface feature characterizations to determine infiltration capability

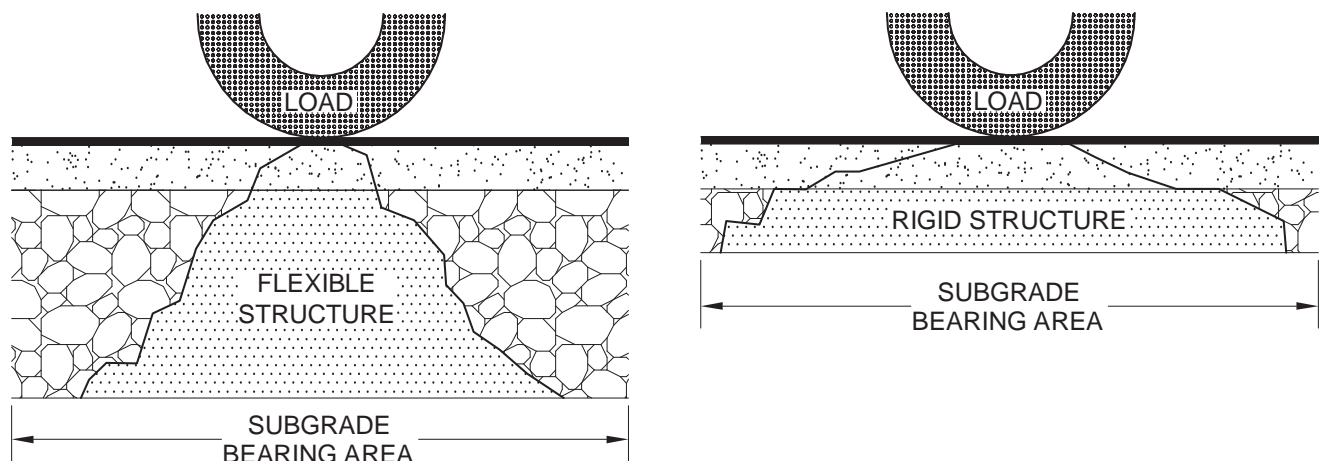

Conceptual diagram of the load distribution provided by rigid (pervious concrete) and flexible permeable pavements and the aggregate base.

Source: Adopted from Ferguson

figure 6.3.10

6

6.3 Permeable Pavement

6.3.2 design & construction

of the site, initial design infiltration rates, and potential locations for permeable pavement. For more information on initial site assessment, see Chapter 2: Site Assessment and Section 2.1: Soil and subsurface characterization.

Determining the infiltration rate of the underlying soil profile is necessary to design the aggregate base depth for stormwater storage and drain system (optional) as well as equate flow reduction benefits when using WWHM or MGSFlood. For details on flow modeling guidance, see Chapter 7. See figure 6.3.12 for a graphic representation of the process to determine infiltration rates.

The following outline the types of required infiltration tests and test methodologies organized by the scale of permeable pavement installation for soil profiles below the aggregate base material.

Small permeable paving installations (patios, walkways and driveways) on private property that include storage volume using base material below the grade of the surrounding land are modeled as gravel infiltration trenches. Infiltration tests for small permeable pavement installations are:

- Required where water quality treatment or flow control thresholds are triggered.
- Recommended for installations below these thresholds.
- Infiltration tests required or recommended for small permeable pavement installations are listed below under large installations and should be performed at the final subgrade elevation.

Large permeable paving installations (sidewalks, alleys, parking lots, roads) that include storage volume using base material below the grade of the surrounding land are modeled as a gravel infiltration trench. Infiltration tests (performed at the final subgrade elevation) are required for large permeable pavement installations.

The methods below are used to determine the short-term (initial) saturated hydraulic conductivity rate for subgrade soil profile (existing) soils under permeable

pavement installations. The initial or measured saturated hydraulic conductivity with no correction factor may be used as the design infiltration rate if the qualified professional engineer determines the following:

- The infiltration testing described below (and perhaps additional tests) are: 1) conducted in locations and at adequate frequencies capable of producing a soil profile characterization that fully represents the infiltration capability where the permeable pavement is located.
- The aggregate base material is clean washed material with < 1 percent fines passing the 200 sieve.

If deemed necessary by a qualified professional engineer, a correction factor may be applied to the measured saturated hydraulic conductivity to determine the long-term (design) infiltration rate. Whether or not a correction factor is used (and the specific number that is used) depends on heterogeneity of the site soils, the number of infiltration tests in relation to the size of the installation, and the percent fines passing the 200 sieve of the aggregate base material (see below for correction factors). The overlying pavement provides excellent protection for the underlying native soil from sedimentation; accordingly, the underlying subgrade soil profile does not require a correction factor for sediment input from sources above the pavement.

The initial K_{sat} can be determined using:

- A. In-situ small-scale pilot infiltration test (small-scale PIT);
- B. in-situ large-scale PIT; or
- C. A correlation to grain size distribution from soil samples if the site has soils that are not consolidated by glacial advance. Method C uses the ASTM soil size distribution test procedure (ASTM D422), which considers the full range of soil particle sizes, to develop soil size distribution curves.

See Section 2.1 Soil and subsurface characterization for test procedure details. The following provides infiltration test procedures specific to permeable pavement.

On commercial property parking lots and driveways, the small-scale PITs should be performed for every 5000 ft² of permeable pavement, but not less than 1 test per site. On residential developments, small-scale PITs should be performed every 200 feet of roadway and at every proposed lot if the driveways are permeable pavement. Tests at more than one site could reveal the advantages of one location over another. However, if the site subsurface characterization, including soil borings across the development site, has consistent characteristics and depths to seasonal high groundwater conditions, the number of test locations may be reduced to a frequency recommended by a geotechnical professional.

Groundwater mounding analysis is not required for permeable pavement installations that do not have stormwater run-on from adjacent impervious surface (infiltrating only precipitation falling on permeable pavement).

Correction factors for subgrade soils underlying permeable pavement installations.

The correction factor for in-situ, small-scale PIT is determined by the number of tests in relation to the size of the permeable pavement installation, site variability, and the quality of the aggregate base material. Correction factors range from 0.33 to 1 (no correction). (See table 6.3.2)

Tests should be located and be at adequate frequency capable of producing a soil profile characterization that fully represents the infiltration capability where the permeable pavement is located. If used, the correction factor depends on the level of uncertainty that variable subsurface conditions justify. If enough PITs are conducted across the permeable pavement subgrade to provide an accurate characterization, or the range of uncertainty is low (e.g., conditions are known to be uniform through previous exploration and site geological factors), then no correction factor for site variability may be justified. Additionally, no correction factor for the quality of pavement aggregate base material may be necessary if the aggregate base is clean washed material with 1 percent or less fines passing the 200 sieve. See Table 6.3.2: Correction factors for in-situ K_{sat} measurements to estimate long-term (design) infiltration rates.

If the level of uncertainty is high, a correction factor near the low end of the range may be appropriate. Two example scenarios where low correction factors may apply include:

- Site conditions are highly variable due to a deposit of ancient landslide debris or buried stream channels. In these cases, even with many explorations and several PITs, the level of uncertainty may still be high.
- Conditions are variable, but few explorations and only one PIT is conducted (i.e., the number of explorations and tests conducted do not match the degree of site variability anticipated).

table 6.3.2 Correction factors for in-situ K_{sat} measurements to estimate long-term (design) infiltration rates

Site Analysis Issue	Correction Factor
Site variability and number of locations tested	CF _y = 0.33 to 1
Quality of pavement aggregate base material	CF _{in} = 0.9 to 1

Total correction factor (CF_t) = CF_y x CF_{in}

6

6.3 Permeable Pavement

6.3.2 design & construction

Verifying subgrade infiltration rates

Pilot Infiltration Tests are appropriate methods for estimating field infiltration rates. Infiltration tests should be conducted at the subgrade surface and followed by excavation into soil profile below the subgrade surface where stormwater will infiltrate (see Section 2.2.1: Soils and subsurface characterization methods for details). Initial infiltration tests, conducted at the projected subgrade surface where the aggregate base is placed, provide necessary information for permeable paving design.

Infiltration tests may also be necessary once the subgrade preparation is complete to verify that infiltration rates used for design have not been significantly reduced from compaction. PITs, and associated excavation beneath the PIT elevation, are not recommended at this stage in order to maintain the structural integrity of the subgrade. Rather, large-scale ring infiltrometer tests are recommended for accuracy and minimal subgrade disturbance (see figure 6.3.11). The large ring infiltration test uses a concrete, metal or plastic ring (minimum diameter of 3 foot) that is placed on the subgrade surface and pressed into the ground with soil backfill packed around the outside of the ring. This test follows the same procedures for timing and measuring water depth as the small-scale PIT; however, there is no excavation below the subgrade surface at the completion of the test.

Utility excavations under or beside the road section can provide pits for soil classification, textural analysis, stratigraphy analysis, and/or infiltration tests and minimize time and expense for permeable paving infiltration tests.

Accessibility

The permeable paving systems examined in this section can be designed to meet ADA requirements. Local, state and federal ADA requirements can vary and designers should check with the permitting jurisdiction for ADA related requirements.



figure 6.3.11

Large ring infiltrometer test.
Source: Photo by Associated Earth Sciences

The federal ADA design guidelines state that surfaces on accessible paths and travel routes should meet the following criteria:

- Firm, stable and slip resistant.

Maximum openings that do not allow insertion of a ½ inch sphere.

Washington State, WAC 51-40-1103 Section 1103 (Building Accessibility) states that abrupt changes in height greater than ¼ inch in accessible routes of travel shall be beveled to 1 vertical in 2 horizontal. Changes in level greater than ½ inch shall be accomplished with an approved ramp. Porous asphalt and pervious concrete, while rougher than conventional paving, do not have abrupt changes in level when properly installed. Concrete pavers have small openings or joints when properly installed and most concrete paver surfaces create smooth surfaces that meet ADA design guidelines. Consult with the paver supplier to confirm their product meets ADA requirements. Plastic and concrete grid systems use a specific aggregate with a reinforcing grid that creates a firm and relatively smooth surface (see Design sections below).

6.3 Permeable Pavement

6

6.3.2 design & construction

figure 6.3.12

Determining subgrade infiltration rates for permeable pavement installations.

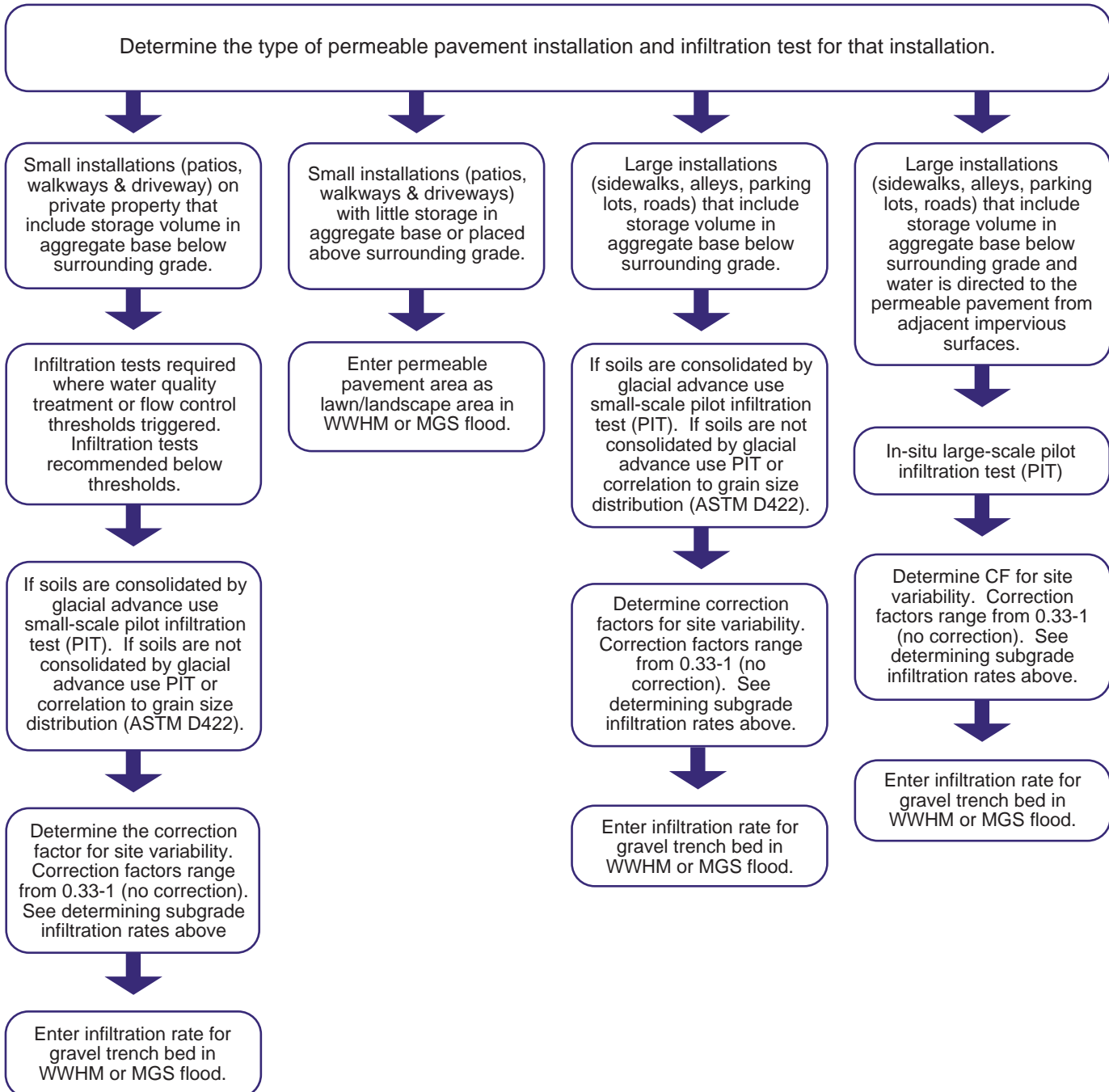

6

6.3 Permeable Pavement

6.3.2 design & construction

Two qualifications for use of permeable paving and designing for ADA should be noted. Sidewalk designs incorporate scoring, or more recently truncated domes, near the curb ramp to indicate an approaching traffic area for the blind. The rougher surfaces of permeable paving may obscure this transition; accordingly, standard concrete with scoring or truncated domes should be used for curb ramps (Florida Concrete and Products Association [FCPA], n.d.). Also, the aggregate within the cells of permeable pavers (such as Eco-Stone) can settle or be displaced from vehicle use. As a result, paver installations for ADA parking spaces and walkways may need to include pavers with smaller permeable joints or pavers constructed with permeable material and tight joints. Individual project designs should be assessed by site characteristics and regulatory requirements of the jurisdiction.

6.3.2.2 Types of permeable pavement

The following section provides design guidelines for porous asphalt, pervious concrete, a permeable interlocking concrete pavement, and a plastic grid system. Each product has specific design requirements and each site has unique characteristics and development requirements. Accordingly, qualified engineers and allied design disciplines, as well as association and manufacturer specifications, should be consulted for developing specific permeable paving systems.

1. Porous hot-mix asphalt

Porous hot or warm-mix asphalt is similar to standard hot or warm-mix asphalt; however, the aggregate fines (particles smaller than No. 30 sieve) are reduced, leaving a matrix of pores that conduct water to the underlying aggregate base and soil (Cahill et al., 2003). Porous asphalt is commonly used for light to medium duty applications, including residential access roads, driveways, utility access, parking lots, and walkways; however, porous asphalt has been used for heavy applications, such as airport runways (with the appropriate polymer additive to increase

bonding strength), auto storage at ports, and highways (Hossain, Scofield and Meier, 1992). Properly installed and maintained porous asphalt should have a structural service life that is comparable or longer than conventional asphalt (personal communication Tom Cahill, 2003).

Early applications of porous asphalt were subject to fairly rapid decline of infiltration rates and surface raveling. The primary cause of these problems was inadequate binder strength and associated drain-down of the binder from higher to lower elevation in the pavement. As a result, the binder coating and cohesion between the surface aggregate is reduced and the aggregate dislodges from vehicle wear. The additional binder moving downward in the pavement then collects just below the asphalt surface as it thickens from entrained particles lodged in the pores and as temperatures decline from the surface. The additional binder forms a layer that clogs the porous asphalt pores and reduces infiltration.

In addition to the guidelines specific to porous asphalt, see Section 6.3.2.1 for guidelines on common permeable pavement components.

Design and construction

Several porous asphalt mixes and design specifications have been developed for OGFCs (porous asphalt layer over conventional asphalt) and as wearing courses that are composed entirely of a porous asphalt mix. The OGFCs are designed primarily to reduce noise, glare off standing water at night, and hydroplaning. OGFC can provide significant water quality treatment benefits; however, this design approach provides minimal attenuation of stormwater flows during the wet season in the Puget Sound region.

The following provides specifications and installation procedures for porous asphalt applications where the wearing top course is entirely porous, the base course accepts water infiltrated through the top course, and the primary design objective is to significantly or entirely attenuate storm flows.

Applications include but are not limited to: parking lots, residential access and collector roads, light arterial roads, pedestrian and bike paths, and utility access.

Soil infiltration rate

- See Chapter 5 of Volume V of the 2012 SWMMWW for minimum infiltration rates. Soils with lower infiltration rates may require under-drains or elevated drains to prevent periodic saturation within 6 inches of the bottom of the pavement (wearing course) section.
- Surface flows directed from adjacent areas to the pavement surface or subgrade can introduce excess sediment, increase clogging, result in excessive hydrologic loading, and should only be considered with particular attention to sediment control, infiltration capacity of the subgrade, and adequate maintenance.

Subgrade

- See Section 6.3.2.1 Common components and design criteria for permeable pavement systems for guidelines and construction techniques to reduce compaction.

Under-drain.

- An under-drain or elevated drain can be used for installations with seasonally high groundwater or subgrade infiltration rates to prevent periodic saturated conditions within 6 inches from the bottom of the pavement. An orifice can be used to improve detention. See under-drain design details in Section 6.3.2.1 Common components and design criteria for permeable pavement systems.
- On extremely poor soils with low strength and very low infiltration rates, use an impermeable liner with under-drains.
- Installations should have an observation well (typically 6-inch or 15-cm perforated pipe) extended to the subgrade surface and installed at the furthest downslope area.

Aggregate base/storage bed material

- Minimum base depth for structural support should be 6 inches for pedestrian use and 12 inches for vehicular loading (Porous Asphalt Summit, 2009).
- Maximum depth is determined by the extent to

figure 6.3.13

Porous asphalt section.
Source: AHBL

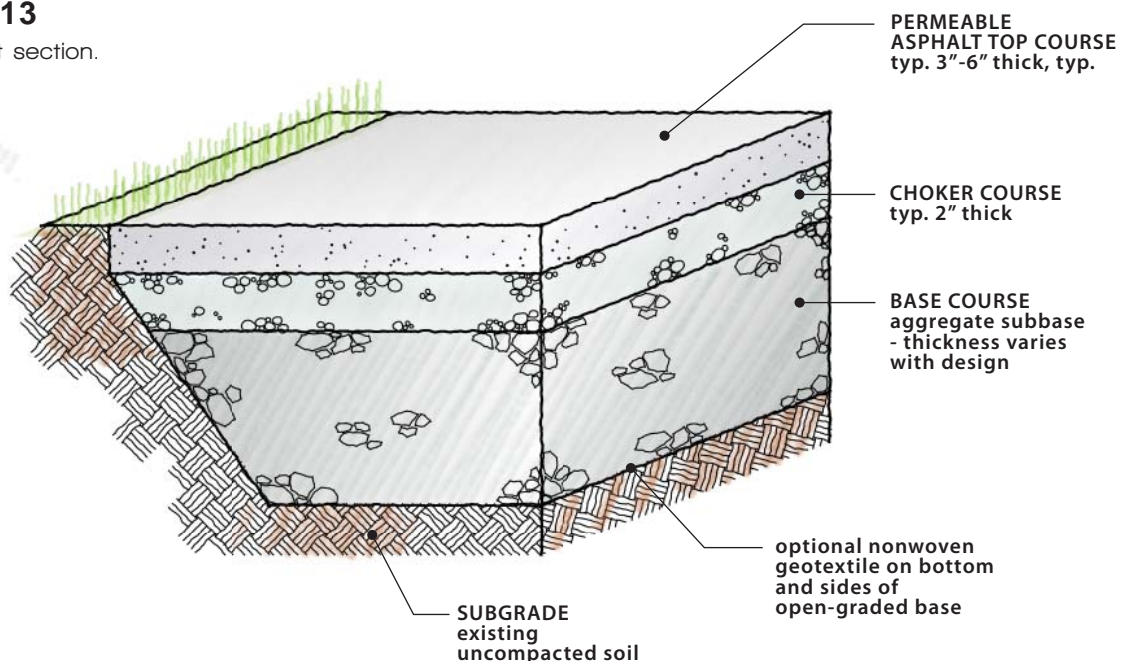

6

6.3 Permeable Pavement

6.3.2 design & construction

which the designer intends to achieve a flow control standard with the use of a below-grade storage bed. Aggregate base depths of 12-24 inches are common depending on storage needs.

- Aggregate: several aggregate gradations can be used for a porous asphalt base. For a successful installation the aggregate should: 1) have adequate voids for water storage (20-40 percent voids is typical); 2) be clean and have minimal fines (0-2 percent passing the 200 sieve maximum); and 3) be angular and have adequate fractured face to lock together and provide structural support (70 percent minimum and 90 percent preferred for fractured face). Two example aggregate guidelines are provided below:
 1. WSDOT Permeable Ballast (9-03.9(2) $\frac{3}{4}$ to 2.5 inches) with a 1-2 inch deep choker course consisting of the same aggregate gradation that is use for the pavement wearing course (see below).
 2. $\frac{3}{4}$ to 1½-inch, clean coarse, crushed rock aggregate with 0-2 percent passing the 200 sieve. This gradation provides a uniform working surface and does not require a choker course. However, additional attention during installation of the pavement is required (see below).

Aggregate base/storage bed installation

- Stabilize area and install erosion control to prevent runoff and sediment from entering storage bed.
- Geotextile fabric: optional.
 - » See Section 6.3.2.1 Common components and design criteria for permeable pavement systems for geotextile.
- Install base aggregate in maximum of 8-inch lifts and lightly compact each lift. Compact complete aggregate base with a minimum 10-ton vibratory roller. Use a 13,500 lbf plate compactor with a compaction indicator in places that can't be reached by roller compactor. Make two passes with the roller in vibratory mode and two

passes in static mode until there is no visible movement of the aggregate. Moist aggregate will compact more thoroughly than dry aggregate. Do not crush the aggregate during compaction. Compacted aggregate sub-base and base should not rut under aggregate delivery trucks or other construction equipment.

- Use back dumping method described in Section 6.3.2.1 Common components and design criteria for permeable pavement systems.
- If used, install choker course evenly over surface of course aggregate base and compact.
- Behind asphalt delivery trucks and in front of asphalt installation, rake out ruts caused by delivery trucks to provide a uniform surface and pavement depth.

Pavement or wearing course materials

An example aggregate gradation and bituminous asphalt cement guideline used successfully used in the Puget Sound region are provided below. Material availability may vary regionally and mix design may vary for those materials. Note: Do not use OGFC specs - stability of OGFCs rely on their asphalt bases.

- Thickness:
 - » Porous asphalt has a slightly lower structural contribution than conventional asphalt. Follow National Asphalt Pavement Association literature on the structural contribution and recommended asphalt pavement thicknesses.
 - » Parking lots: 2-4 inches typical, 3 inches minimum recommended.
 - » Residential access roads and arterials: 4-6 inches typical.

6.3 Permeable Pavement

6

6.3.2 design & construction

- Aggregate gradation:
 - » U.S. Standard Sieve

<u>Percent</u>	<u>Passing</u>
¾"	100
½"	90-100
⅜"	70-90
4	20-40
8	10-20
40	7-13
200	0-3
 - » A small percentage of fine aggregate is necessary to stabilize the larger porous aggregate fraction. The finer fraction also increases the viscosity of the asphalt cement and controls asphalt drainage characteristics.
- Bituminous asphalt cement:
 - » Content: 6.0-6.5 percent by weight of total (dry aggregate) mix. Performance Grade (PG): 70-22. Do not use an asphalt cement performance grade less than 70-22 for open graded, porous asphalt mixes. Note that supplies of PG 70-22 may be limited in the winter season.
 - » Drain-down: 0.3 percent maximum according to ASTM D6390-05.
 - » An elastomeric polymer can be added to the bituminous asphalt cement to reduce drain-down (note: PG 70-22 and stiffer PG grades usually contain and elastomeric polymer).
 - » Fibers can be added and may prevent drain-down.
 - » Anti-stripping agent: as water moves through the porous asphalt pavement, the asphalt emulsion contact with water increases compared to conventional impervious asphalt. An ant-stripping agent reduces the erosion of asphalt binder from the mineral aggregate and is, therefore, recommended for porous asphalt. A qualified products list of anti-stripping additives is available from WSDOT under Standard Specification: 9-02.4. Use an approved test for anti-strip

such as AASHTO T 283-07 Standard Method of Test for Resistance of Compacted Asphalt Mixtures to Moisture-Induced Damage or the Hamburg test.

Total void space should be approximately 16-25 percent per ASTM D3203 (conventional asphalt is 2-3 percent) (NAPA, 2008).

Pavement or wearing course installation

The porous asphalt pavement installations use the same equipment and similar procedures as conventional asphalt with three notable differences:

- Mixing temperature should be 260-280 F and 240-260 F for lay down. Air temperature should be no lower than 45 F and rising.
- The stiffer performance grade for the bituminous asphalt cement adheres more to delivery trucks and installation machinery; accordingly, additional time is required to clean equipment.
- Permeable pavement aggregate base and choker courses are relatively uniform gradations and low in fine material. As a result, equipment operating on the aggregate base will cause more rutting than on more densely graded base material for conventional pavement and will require more



figure 6.3.14

Porous asphalt with conventional impervious asphalt to test water quality treatment capability of permeable pavement at the Washington State University LID research facility.

Source: Curtis Hinman

6

6.3 Permeable Pavement

6.3.2 design & construction

hand labor to smooth ruts and prevent areas where the pavement is either too thin or too thick.

General installation

- Install porous asphalt system toward the end of construction activities to minimize sediment problems. The subgrade can be excavated to within 6"-12" inches of final subgrade elevation and grading completed in later stages of the project (Cahill et al., 2003).
- Erosion and introduction of sediment from surrounding land uses should be strictly controlled during and after construction. Erosion and sediment controls should remain in place until area is completely stabilized with soil amendments and landscaping.
- Insulated covers over loads during hauling can reduce heat loss during transport and increase working time (Diniz, 1980). Temperatures at delivery that are too low can result in shorter working times, increased labor for hand work, and increased cleanup from asphalt adhering to machinery (personal communication Leonard Spadoni, April 2004).
- As with any paving system, rising water in the underlying aggregate base should not be allowed to saturate the pavement (Cahill et al., 2003). To ensure that the asphalt top course is not saturated from excessively high water levels in the aggregate base due to low subgrade permeability, a positive overflow (elevated drain) can be installed.

Minimum infiltration rate for the pervious concrete pavement

The minimum infiltration rate for newly placed porous asphalt should be 200 in/hr. Use ASTM C1701 to test infiltration rates at locations representative of the pavement finished product at a maximum rate of 5,000 ft² per test.

Backup systems for protecting porous asphalt systems

- See Section 6.3.2.1 Common components and design criteria of permeable pavement systems for backup or overflow guidelines and construction techniques.

2. Portland cement pervious concrete

Material and installation specifications for pervious concrete in Washington were originally derived primarily from the field experience and testing of the Florida Concrete and Products Association. Over the past several years, industry groups, designers, installers, and local jurisdictions in the Puget Sound region have gained considerable expertise in mix design and installation. Puget Sound is now considered one of the leading regions in the U.S. for the application of pervious concrete for stormwater management.

Pervious Portland cement concrete is similar to conventional concrete with no or reduced fine aggregate (sand). The mixture is a washed crushed or round coarse aggregate (typically $\frac{3}{8}$ or $\frac{1}{4}$ -inch), hydraulic cement, admixtures (optional), and water. The combination of materials forms an agglomeration of coarse aggregate surrounded and connected by a thin layer of hardened cement paste at their points of contact. When hardened, the pavement produces interconnected voids that conduct water to the underlying aggregate base and soil (ACI 522R-10, 2010). Pervious concrete can be used for various light to heavy duty applications supporting low to moderate speeds. Properly installed and maintained concrete should have a structural life comparable to conventional concrete.

Pervious concrete pavement is a rigid system and does not rely to the same degree as flexible pavement systems on the aggregate base for structural support. Designing the aggregate base will depend on several factors, including project specific stormwater flow control objectives (retention or detention storage), costs, and regulatory restrictions. As with other permeable pavement systems, deeper aggregate base courses (e.g., 12-24 inches) can provide important benefits including significant reduction of above ground stormwater retention or detention needs and uniform and improved subgrade support (FCPA, n.d.). See Chapter 7 for more information on flow modeling guidance.



figure 6.3.15

Pervious concrete parking for a high-density residential project in Bellingham, WA.

Source: Curtis Hinman



figure 6.3.16

Decorative pervious concrete.

In addition to the guidelines specific to pervious concrete, see Section 6.3.2.1 for guidelines on common permeable pavement components.

Design and construction

The following provides design guidelines that apply broadly to pervious concrete pavements. Design of pavements should be performed by experienced engineers with geotechnical and traffic data for the particular site and industry standards, materials, and methods specific to pervious concrete should be followed. Over the past several years, pervious concrete mixes that include proprietary additives have been developed with varying degrees of success. The following section examines standard concrete mix design characterized by washed course aggregate (e.g., ¼ or ⅜-inch), hydraulic cement, admixtures (optional), and water with no proprietary ingredients.

ACI 522 is the current national standard for specification of pervious concrete pavement. This manual defers to the current version of ACI 522 for developing pervious concrete pavement specifications. Included below are specific sections of ACI 522 relevant to this design manual and additional guidelines for infiltration rates, subgrade preparation, and aggregate base placement specific to this region and developed from national and local experience.

Applications: parking lots, driveways, sidewalks, trails, promenades, utility access, commercial parking, and residential roads.

Soil infiltration rate:

- See Chapter 5 of Volume V of the 2012 SWMMWW for minimum infiltration rates. Soils with lower infiltration rates may require under-drains or elevated drains to prevent periodic saturated conditions within 6 inches of the bottom of the aggregate base (interface of the subgrade and aggregate base).
- Surface flows directed from adjacent areas to the pavement surface or subgrade can introduce excess sediment, increase clogging, and result in

6

6.3 Permeable Pavement

6.3.2 design & construction

excessive hydrologic loading; therefore, special attention should be paid to sediment control and infiltration capacity of the subgrade, and adequate maintenance.

Subgrade

- See Section 6.3.2.1 Common components and design criteria for permeable pavement systems for guidelines and construction techniques to reduce compaction.

Under-drain

- An under-drain or elevated drain can be used for installations with seasonally high groundwater or subgrade infiltration rates that create prolonged saturated conditions at the ground surface and within 6 inches from the bottom of the pavement. An orifice can be used to improve detention. See Section 6.3.2.1 for under-drain design details.
- On extremely poor soils with low strength and very low infiltration rates, use an impermeable liner with under-drains.
- Installations should have an observation well (typically 6-inch perforated pipe) extending to the subgrade surface and installed at the furthest downslope area.

Aggregate base/storage bed materials

- The minimum base depth should be 6 inches (FCPA, n.d.).
- Maximum depth is determined by the extent to which the designer intends to achieve a flow control standard with the use of a below-grade storage bed. Aggregate base depths of 6-18 inches are common when designing for retention or detention.
- The coarse aggregate layer varies depending on structural and stormwater management needs. Typical placements are crushed washed aggregate and include WSDOT Permeable Ballast (9-03.9(2) ¾-2.5 inches). Do not use round rock where perimeter of the base aggregate is not confined (e.g., sidewalk placed above grade). Round rock will easily move or roll from the

perimeter of the aggregate base, creating weak voids with no structural support for the pavement.

- The concrete can be placed directly over the coarse aggregate or an open graded leveling course (e.g., 1.5-inch to US sieve size number 8 or AASHTO No 57 crushed washed stone), which may be placed over the larger stone for final grading to provide a more stable, uniform working surface and reduce variation in thickness.

Aggregate base/storage bed installation

- Stabilize area and install erosion control to prevent runoff and sediment from entering storage bed.
- Geotextile fabric (optional):
 - » See Section 6.3.2.1 Common components of permeable pavement systems and design criteria for geotextiles.
- Install coarse aggregate in maximum of 8-inch lifts and compact each lift (U.S. Army Corps of Engineers, 2003). Use back dumping method described in Section 6.3.2.1 Common components and design criteria for permeable pavement systems to protect subgrade from compaction.
- If utilized, install a 1 to 2-inch leveling course (typically No. 57 AASHTO crushed, washed stone) evenly over surface of coarse aggregate base and lightly compact to stabilize to provide a more stable, uniform working surface and reduce variation in thickness.

Pavement materials

The following guidelines provide typical ranges of materials for pervious concrete. Proper mix design and the resulting performance of the finished product depends on the specific aggregate used and proper cement content and water-cement ratios determined by that aggregate. Consult the qualified concrete supplier, local jurisdiction specifications, and ACI 522.1 for developing final mix design.

- Pavement thickness:
 - » Parking lots: 5-9 inches typical.
 - » Roads: 6-12 inches typical.

- Unit weights: 120-135 pounds per cubic foot \pm 5 percent typical. Pervious concrete is approximately 70-80 percent of the unit weight of conventional concrete) (FCPA, n.d.).
- Void content: 18-20 percent \pm 3-5 percent typical per ASTM C138/C138M (interconnectivity of voids and, therefore, infiltration rates are inadequate below 15 percent) (ACI 522). Void content is measured indirectly by determining fresh (wet) concrete density using ASTM C138/C138M or ASTM C1688/CC1688M and is a secondary measure reflecting strength and permeability of the hardened concrete. Acceptable permeability, strength and appearance is primarily determined by the test panel (see *Quality control, testing and verification* section below), which in part includes comparing unit weights of the accepted test panel cores and finished work cores.
- Water cement ratio: 0.26-0.45 provides the optimum aggregate coating and paste stability. Water content is a critical design element of pervious concrete. If too dry, cohesiveness and cement hydration efficiency may be reduced. If too wet, the cement paste may drain down and result in a weak upper structure and clog the lower portion of the pavement (ACI 522, 2010).
- Total cementitious material content: for the development of strength and void structure total cementitious material content should be determined by the supplier and identified in the mix design submittal. Total cementitious content will range from 470-564 pounds per cubic yard. The optimum content is entirely dependent on aggregate size, void content and gradation (ACI 522, 2010).
- Aggregate: gradations are typically either single-sized coarse aggregate or gradations between $\frac{3}{4}$ and $\frac{3}{8}$ -inch. Typical in the Puget Sound are $\frac{1}{4}$ or $\frac{3}{8}$ -inch clean crushed or round aggregate. In general the $\frac{1}{4}$ -inch crushed or round produces a slightly smoother surface than coarser aggregate. Aggregate should meet requirements of ASTM D448 and C33/C33M. Aggregate moisture at mixing is important to produce adequate



figure 6.3.17

Proper cement consistency and coverage of aggregate.

Source: Bruce Chaitin

workability and prevents draining of paste (ACI 522, 2010).

- Portland cement: Type I or II conforming to ASTM C150/C150M, C595/C595M or C1157/C1157M. Supplementary cementitious materials such as fly ash, ground blast furnace slag and silica fume can be added to Portland cement. Testing material compatibility is strongly recommended (ACI 522, 2010).
- Admixtures: water reducing/retarding, viscosity modifiers and hydration stabilizers can be used to increase working time and improve the workability of the pervious concrete mix.
- Water: Use potable water.
- Fibers may add strength and permeability to the placed concrete, are recommended, and can be used as an integral component of the concrete mix.

Pavement placement

- See testing section below for confirming correct mixture and proper installation.
- With the correct water content, the delivered mix should contain a cement paste that smoothly covers all the aggregate particles while at the

6

6.3 Permeable Pavement

6.3.2 design & construction

same time the paste does not slide or drain off the particles. The paste should adhere the aggregate particles to each other.

- Pervious concrete mix should be placed within 60 minutes of water being introduced to the mix, and within 90 minutes of using an extended set control admixture (ACI 522) or an admixture recommended by the manufacturer.
- Adding water in the truck at the point of discharge of the concrete should be allowed to attain optimum mix consistency, workability, placement, and finish (ACI 522).
- Base aggregate should be wetted to reduce moisture loss and improve the curing process of pervious concrete.
- Concrete should be deposited as close to its final position as possible directly from the truck, using a conveyor belt or hand or powered carts (pervious concrete mixes are stiff and cannot be pumped).
- Several screed and compaction methods can be used, including low frequency vibrating truss screeds, laser screeds, and hand screed that levels the concrete at above form (typically 3/8-3/4-inch). The surface is then covered with 6-mil plastic and a static drum roller is used for final compaction (roller should provide approximately 10 pounds per square inch vertical force). A method that is becoming more prevalent and that has advantages for quality of finish and speed are rotating Bunyan screeds or hydraulically powered screeding drums that provide proper compaction at the finished elevation and a nearly-finished surface in one operation (see figure 6.3.18). Hydraulically operated screeding drums come in various lengths and diameters.
- Placement widths should not exceed 15 feet unless contractor can demonstrate competence with test panels or

previous installations to install greater widths.

- High frequency vibrators can seal the surface of the concrete and should not be used.
- Jointing: Shrinkage associated with drying is significantly less for pervious than conventional concrete. Accordingly, control joints are optional. If used, spacing of joints should follow the rules for conventional concrete and should typically be spaced at maximum 15-20 foot intervals. Joint depth should be $\frac{1}{4}$ - $\frac{1}{3}$ the depth of the pavement thickness. Control joints can also facilitate a cleaner break point if sections become damaged or are removed for utility work.

Curing

Due to its porous, open structure, pervious concrete dries rapidly. If curing is not controlled, the bond between the aggregate becomes weak and structural integrity will be seriously compromised. Curing is, therefore, a critical step in pervious concrete installation and the following steps should be carefully planned and implemented (ACI 522):

figure 6.3.18

Hydraulically operated Bunyan screed compacts and provides the finished elevation in one operation.

Source: SVR



- Completely cover surface and edges with 6-mil plastic within 20 minutes of concrete discharge. The surface and edges should remain entirely covered for the entire curing time.
- Curing time: 7 days for pervious concrete with no additives and 10 days for mixtures that incorporate supplementary cementitious materials, such as fly ash and slag (ACI 522, 2010).
- Secure all edges adequately so that the plastic cannot be dislodged during cure time. Lumber, reinforcing bars, and concrete blocks can be used to secure the plastic continuously along the perimeter. If wooden forms are used, riser strips can be nailed back in place to secure plastic. Do not use dirt, sand or other granular material on the plastic because the sediment may wash or spill into the pores of the concrete during rainfall or removal of plastic (ACI 522, 2010).

Note that admixtures are now becoming available that reduce or eliminate the need to cover the pavement installation with plastic. Consult ACI 522, industry representatives, and suppliers for recommendations.

Quality control, testing and verification

The following provides a summary of quality control in ACI 522. Quality control and testing procedures to verify proper placement include test panels, fresh and hardened density, and average compacted thickness of the installation. It is critically important to require adequate NRMCA-certified placement personnel and contractor experience for the installation (see ACI 522 for more details). There are currently no generally accepted standardized methods to test compression or flexural strength of pervious concrete, and tests used for conventional concrete are not applicable due to the high variability in strength within the porous structure of pervious concrete and should not be used for verification (ACI 522, 2010).

- The contractor should place test panels using mix proportions, materials, personnel, and equipment proposed for the project. Test the fresh and hardened density and thickness of the test panel(s). See the current version of ACI 522 for

test procedures and tolerances. If the test panel is outside acceptable limits for one or more of the verification tests, the panel should be removed and replaced at the contractor's expense. If the test panel is accepted it may be incorporated into the completed installation.

- Obtain a minimum 1 ft³ sample for fresh density testing for each day of placement (see ACI 522 for test procedures and tolerances).
- Remove 3 cores per 5000 ft² not less than seven days after placement to verify placement hardened density and thickness. See ACI 522 for test procedures and tolerances. If the tested portion of the installation is outside acceptable limits for 1 or more of the verification tests, the installation is subject to rejection and should be removed and replaced at the contractor's expense unless accepted by the owner.

Minimum infiltration rate for the pervious concrete pavement

The minimum infiltration rate for newly placed pervious concrete should be 200 in/hr. Use ASTM C1701 to test infiltration rates of the test panel and at locations representative of the pavement finished product at a maximum rate of 5,000 ft² per test.

Backup systems for protecting pervious concrete systems

- See Section 6.3.2.1: Common components and design criteria of permeable pavement systems for backup or overflow guidelines and construction techniques.

3. Permeable interlocking concrete pavement

Permeable interlocking concrete pavers are designed with various shapes and thicknesses from high-density concrete to allow infiltration through a built-in pattern of openings or joints filled with aggregate. Pavers are typically 3¹/₈ inches thick for vehicular applications and pedestrian areas may use 2³/₈ inches thick units (Smith, 2011). When compacted, the pavers interlock and transfer vertical loads to surrounding pavers by shear forces through aggregate in the joints (Pentec Environmental, 2000). Interlocking pavers are placed

6

6.3 Permeable Pavement

6.3.2 design & construction

on open graded sub-base aggregate topped with a finer aggregate layer that provides a level and uniform bedding material. Properly installed and maintained, high-density pavers have high load bearing strength and are capable of carrying heavy vehicle weight at low speeds. Properly installed and maintained pavers should have a service life of up to 40 years (Smith, 2011).

Design and construction

The Interlocking Concrete Pavement Institute (ICPI) provides technical information on best practices for PICP design, specification, construction, and maintenance. Manufacturers or suppliers of particular pavers should be consulted for materials and guidelines specific to that product. Experienced contractors with a certificate in the ICPI PICP Installer Program should perform installations. This requirement should be included in project specifications. The following provides design guidelines that apply broadly to permeable interlocking concrete pavers.

Applications: Industrial and commercial parking lots, industrial sites that do not receive hazardous materials, utility access, low speed (<40 mph) residential access roads, driveways, patios, promenades, and walkways.

Soil infiltration rate:

- See Chapter 5 of Volume V of the 2012 SWMMWW for minimum infiltration rates. Soils with lower infiltration rates may require under-drains or elevated drains to prevent prolonged saturated soil conditions within 1 foot of the bottom of the aggregate base (interface of the subgrade and aggregate base).
- Surface flows directed from adjacent areas to the pavement subgrade or surface can introduce excess sediment, increase clogging, result in excessive hydrologic loading, and special attention should be paid to sediment control and infiltration capacity of the subgrade.



figure 6.3.19

Permeable interlocking concrete pavers.
Source: Photo by Curtis Hinman

Subgrade

- Open graded subbase: No. 2 stone.
- Open graded base: No. 57 stone.
- Bedding course: No. 8 stone, typ.
- Soils should be analyzed by a qualified professional for infiltration rates and load bearing, given anticipated soil moisture conditions.
- The ICPI recommends a minimum CBR of 4 percent (96-hour soak per ASTM D 1883 or AASHTO T 193) to qualify for use under vehicular traffic applications (Smith, 2011).
- See Section 6.3.2.1 Common components and design criteria for permeable pavement systems for guidelines and construction techniques to reduce compaction.

Aggregate base/storage bed materials

- Minimum sub-base thickness depends on vehicle loads, soil type, stormwater storage requirements, and freeze thaw conditions. Typical sub-base depths range from 6-24 inches. ICPI recommends base/sub-base thicknesses for pavements up to a lifetime of 1 million 18,000 lb equivalent single axle loads or ESALs. For example, at lifetime ESALs of 500,000 with a CBR of 5 percent, the sub-base (ASTM No. 2 stone) should be 18 inches and the base (ASTM No. 57 stone) thickness should be 4 inches. Increased aggregate sub-base thicknesses can be applied for increased stormwater volume storage. See ICPI guidelines for details on base thickness and design (Smith 2011).
- Minimum sub-base depth for pedestrian applications should be 6 inches (Smith, 2011).
- See figure 6.3.21 for aggregate sub-base, base, bedding course, and paver materials.
- The sub-base and base aggregate should be hard, durable, crushed stone with 90 percent fractured faces, a **Los Angeles (LA) Abrasion** of < 40 (per ASTM C131 and C535) and a design CBR of 80 percent (Smith, 2011).

Aggregate base/storage bed installation

- Stabilize area and install erosion control or diversion to prevent runoff and sediment from entering aggregate sub-base, base, and pavers.

**figure 6.3.20**

Permeable interlocking concrete pavement.
Top: Scenic Heights Trailhead Park,
Bottom: Burnaby, British Columbia
Source: Smith, 2011

6

6.3 Permeable Pavement

6.3.2 design & construction

Prevent sediment from contaminating aggregate base material if stored onsite.

- If using the base course for retention in parking areas, excavate subgrade level to allow even distribution of water and maximize infiltration across entire parking area.
- Geotextile fabric (optional):
 - » Geotextiles are recommended on the sides of excavations where a full-depth concrete curb is not used to prevent erosion of adjacent soil into the aggregate base. The fabric should extend at least 1 foot onto the subgrade bottom. A minimum overlap of 1 foot is recommended for well-drained soils and 2 feet for poor-draining soils (Smith, 2011).
 - » The use of geotextiles on the bottom of the subgrade excavation is optional.
 - » See Section 6.3.2.1 Common components and design criteria for permeable pavement systems for recommended use and geotextile installation.
- Install No. 2 stone in 6-inch lifts. Use back dumping method described in Section 6.3.2.1 Common components and design criteria for permeable pavement systems to protect subgrade from compaction. Compact with at least 4 passes of a 10-ton steel drum vibratory roller or a 13,500 lbf plate compactor. The first two passes should be with vibration and the final two passes should be static. Consolidation of the sub-base is improved if the aggregate is wet. Compaction is complete when there is no visible movement in the sub-base as the roller moves across the surface (Smith, 2011).
- The No. 57 stone base can be spread as one, 4-inch lift. Compact with at least 4 passes of a 10-ton steel drum vibratory roller or a 13,500 lbf plate compactor. The first two passes should be with vibration and the final two passes should be static. The No 57 stone should be installed moist to facilitate proper compaction.
- Adequate density and stability are developed when no visible movement is observed in the base as the roller moves across the surface (personal communication, Dave Smith ICPI). If field testing is required, a nuclear density gauge can be used on the No 57 base in backscatter mode; however, this type of test is not effective/ appropriate for the larger No 2 sub-base stone. A non-nuclear stiffness gauge can be used to assess aggregate base density as well (Smith, 2011).
- Asphalt stabilizer can be used with the No. 57 and/or the No 2 stone if additional bearing support is needed, but should not be applied to

figure 6.3.21

*PICP section detail.
Source: Smith, 2011*

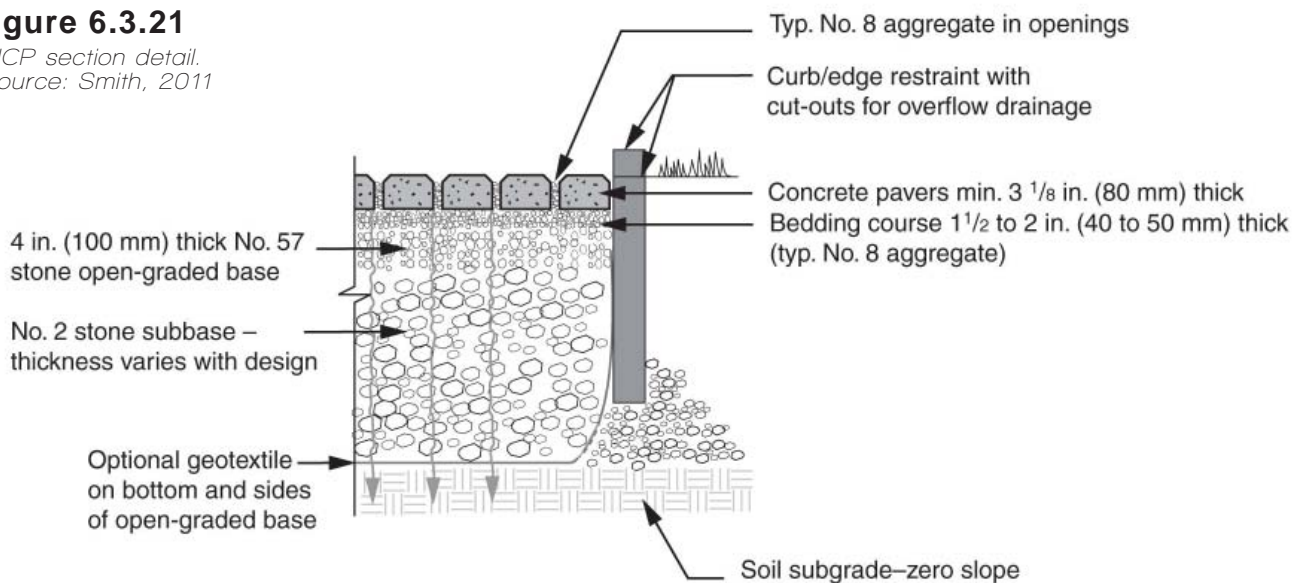

the No.8 aggregate. To maintain adequate void space, use a minimum of asphalt for stabilization (approximately 2-2.5 percent by weight of aggregate). An asphalt grade of AC20 or higher is recommended. The addition of stabilizer will reduce storage capacity of base aggregate and should be considered in the design (Smith, 2000).

Bedding layer installation

- Install 2 inches of moist No. 8 stone for the leveling or choker course over compacted base. Screed and level No. 8 stone to within $\pm\frac{3}{8}$ inch over 10 feet surface variation. The No. 8 aggregate should be moist to facilitate movement into the No 57 stone. Keep construction equipment and foot traffic off screed bedding layer to maintain uniform surface for pavers.

Under-drain

- Under-drain: three under-drain configurations are typical depending on stormwater management goals and infiltration capacity:
 - » For installations with soil permeability that allows for adequate infiltration to meet stormwater management goals, an optional elevated drain may be incorporated to protect installation from extreme events.
 - » On extremely poor soils with low strength or very low infiltration rates, use an impermeable liner with under-drains. An orifice can be used to improve detention. See Section 6.3.2.1 for under-drain design details.
 - » All installations should have an observation well (typically 6-inch perforated pipe) installed at the farthest downslope area. The well should be inserted into the subgrade 4-6 inches and kept 3 feet from the side of the installation (Smith, 2011).

Edge restraints

The type of edge restraint depends on whether the application is for pedestrian, residential driveway or vehicular use. For vehicular installations, use a cast-in-place curb (typically 9 inches deep) that rests on the top of the sub-base, or one that extends the full depth

of the base and sub-base. If the paver installation is adjacent to existing impervious pavement, the curb should extend to the full depth of pavement and aggregate base to protect the impervious installation base from excessive moisture and weakening. If the concrete curb does not extend the full depth an impermeable liner can be used to separate the two base materials (Smith, 2011).

Cast-in-place concrete curbs or dense-graded berms to provide a base to secure spiked metal or plastic edge restraints can be used for pedestrian and residential driveway applications. An additional option for pedestrian and light parking application is a sub-surface concrete grade beam with pavers cemented to the concrete beam to create a rigid paver border.

Paver installation

- Pavers should be installed immediately after base preparation to minimize introduction of sediment and to reduce the displacement of bedding and base material from ongoing activity (Smith, 2000).
- Place pavers by hand or with mechanical installer. Paver joints are filled with No. 8, 89 or 9 stone. Spread and sweep with shovels and brooms (for small jobs) or small track loaders and power brooms or sweepers (for larger installations). Fill joints to within $\frac{1}{4}$ inch and sweep surface clean for final compaction to avoid marring pavers with loose stones on the surface.
- To maximize efficiency and reduce cost of mechanical installation, consult with the supplier to deliver pavers in layers that will be picked up by the installation machine in the final installed pattern.
- For installations over 50,000 ft² that are installed with mechanical equipment, consult with the paver manufacturer to monitor paver dimension and consistency of paver layers so that layers continue to fit together appropriately throughout installation.
- Cut pavers along borders should be no smaller than $\frac{1}{3}$ of a whole paver if subject to vehicle loading.

6

6.3 Permeable Pavement

6.3.2 design & construction

- NOTE: Do not use sand to fill paver openings or joints unless specified by the manufacturer. Sand in paver openings and joints can clog easily and will significantly reduce surface infiltration and system performance if system is not specifically designed for sand.
- Compact pavers with a 5,000 lbf, 75-90 Hz plate compactor. Use a minimum of two passes with each subsequent pass perpendicular to the prior pass.
- If aggregate settles to more than ¼ inch from the top of the pavers, add stone, sweep clean, and compact again. The small amount of finer aggregate in the No. 8 stone will likely be adequate to fill narrow joints between pavers in pedestrian and vehicular applications. Sweep in additional material as required. ASTM No. 89 or 9 stone can be used to fill spaces between pavers with narrow joints. In all cases, however, the bedding material should be ASTM No. 8 stone (Smith 2011).
- For vehicular installations, proof roll with at least two passes of a 10-ton rubber-tired roller.
- Do not compact pavers within 6 feet of unrestrained edges (Smith 2011).
- The PICP installation contractor should return to the site after 6 months from completion of the work and provide the following if necessary: fill paver joints with stones, replace broken or cracked pavers, and re-level settled pavers to specified elevations. Any rectification work should be considered part of original bid price with no additional compensation.

For detailed design guidelines and a construction specification see Permeable Interlocking Concrete Pavements (Smith, 2011).



figure 6.3.22

Mechanical paver installation.

Source: Curtis Hinman

4. Plastic or concrete grid systems

Plastic or concrete grid systems come in several configurations. The goal for all plastic grid systems is to create a stable, uniform surface to prevent compaction of the gravel or soil and grass fill material that creates the finished surface. Of all the permeable paving systems, grid systems have the largest void space available for infiltration in relation to the solid support structure.

Design and construction

Flexible grid systems conform to the grade of the aggregate base, and when backfilled with appropriate aggregate top course, provide high load bearing capable of supporting fire, safety, and utility vehicles. These systems, when properly installed and maintained, are not impacted by freeze-thaw conditions found in the Puget Sound region and have an expected service life of approximately 20 years (Bohnhoff, 2001).

Applications: Typical uses include alleys, driveways, utility access, loading areas, trails, and parking lots with relatively low traffic speeds (15-20 mph maximum).

Soil infiltration rate:

- See Chapter 5 of Volume V of the 2012 SWMMWW for minimum infiltration rates. Soils with lower infiltration rates may require under-drains or elevated drains to prevent prolonged saturated conditions within 1 foot of the bottom of the aggregate base (interface of the subgrade and aggregate base).
- Surface flows directed from adjacent areas to the pavement subgrade or surface can introduce excess sediment, increase clogging, result in excessive hydrologic loading, and special attention should be paid to sediment control, infiltration capacity of the subgrade, and maintenance.

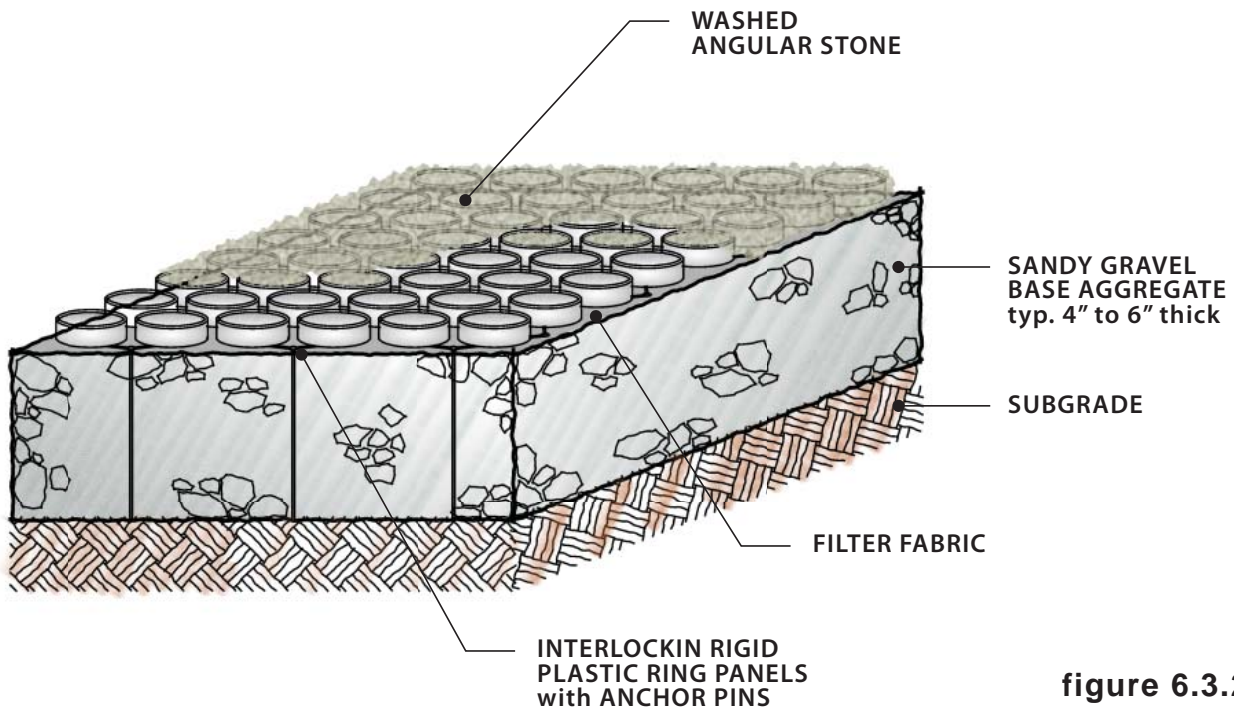

figure 6.3.23

Typical plastic grid cross section.
Source: AHBL

6

6.3 Permeable Pavement

6.3.2 design & construction

Subgrade

- Soil conditions should be analyzed for load bearing, given anticipated soil moisture conditions by a qualified professional.
- See Section 6.3.2.1 Common components and design criteria for permeable pavement systems for guidelines and construction techniques to reduce compaction.

Aggregate base/storage bed materials

- Minimum base thickness depends on vehicle loads, soil type, and stormwater storage requirements. Typical minimum depth is 4-6 inches for driveways, alleys, and parking lots (less base course depth is required for trails) (personal communication Andy Gersen, July 2004). Increased depths can be applied for increased storage capacity if needed to meet flow control goals.
- Typical base aggregate is a sandy gravel material typical for road base construction.

Example aggregate grading:

U.S. Standard Sieve	Percent Passing
1"	100
3/4"	90-100
3/8	70-80
#4	55-70
#10	45-55
#40	25-35
200	3-8

Aggregate base/storage bed installation

- Stabilize area and install erosion control to prevent runoff and sediment from entering storage bed.
- If using the base course for retention in parking areas, excavate storage bed level (if possible) to allow even distribution of water and maximize infiltration across entire parking area (terrace parking area if sloped).
- Geotextile fabric (optional):
 - » See Section 6.3.2.1: Common components and design criteria for permeable pavement systems for guidelines and construction techniques to reduce compaction.
- Install aggregate in 6-inch lifts maximum. Use back dumping method described in Section 6.3.2.1: Common components and design criteria for permeable pavement systems to protect subgrade from compaction.
- Compact each lift of dense-graded aggregate base to 95 percent standard proctor. (Note: For dense-graded bases in light traffic applications, only standard proctor density is required. Modified proctor requires more compactive force and expense and is not needed for the light loads to which grid pavements are constructed.

For open-graded aggregate bases, compact with a minimum 10-ton roller with the first two passes in vibratory mode and the last two in static mode until there is no visible movement of the aggregate.

Aggregate fill for aggregate systems

- Aggregate should be clean, washed, and hard angular stone typically $\frac{3}{16}$ to $\frac{1}{2}$ -inch.

Aggregate fill for grass systems

- For plastic grids, sand (usually with a soil polymer or conditioner), sandy loam or loamy sand are typical fill materials.
- For concrete grids, fill the openings with topsoil.

Top course installation

- Grid should be installed immediately after base preparation to minimize introduction of sediment and to reduce the displacement of base material from ongoing activity.
- Place grid with rings up and interlock male/female connectors along unit edges.
- Install anchors if not integral to the plastic grid. Higher speed and transition areas (e.g., where vehicles enter a parking lot from an asphalt road) or where heavy vehicles execute tight turns will require additional anchors.
- Aggregate fill should be back dumped to a minimum depth of 6 inches so that delivery vehicle exits over aggregate. Sharp turning on rings should be avoided.
- Aggregate fill
 - » Spread gravel using power brooms, flat bottom shovels or wide asphalt rakes. A stiff bristle broom can be used for finishing.

- » If necessary, aggregate can be compacted with a plate compactor to a level no less than the top of the rings or no more than 0.25 inch above the top of the rings (Invisible Structures, 2003).
- Grass systems
 - » Spread sand or soil using power brooms, flat bottom shovels or wide asphalt rakes. A stiff bristle broom can be used for finishing.
 - » Lay sod or seed. Grass installation procedures vary by product. Consult manufacturer or supplier for specific grass installation guidelines.
- Provide edge constraints along edges that may have vehicle loads (particularly tight radius turning). Cast-in-place or pre-cast concrete is preferred.
- Concrete grids require edge restraints along edges in all applications. Plastic grids require restraints when exposed to vehicles. Edge restraints for concrete or plastic grids in such applications should be cast-in-place or pre-cast concrete.

6.3.3 Maintenance

Maintenance is an essential element for the successful, long-term application of permeable pavement. Objectives of a comprehensive maintenance program for permeable pavement should include:

- Clear, enforceable guidelines for maintenance on private and public right-of-ways.
- Education materials describing the materials, function, and proper maintenance of permeable pavements on private property.
- Mechanisms to supply new homeowners with educational materials.
- Effective sediment and erosion control.
- Location of facilities, timing of, and equipment for, maintenance activities.
- Methods for testing pavement infiltration rates over time.
- Periodic evaluation of maintenance programs and adaptive management to improve effectiveness of maintenance procedures.

The following provides maintenance recommendations applicable to all permeable paving surfaces and specific permeable pavement systems.

Maintenance recommendations for all facilities

- Erosion and introduction of sediment from surrounding land uses should be strictly controlled after construction by amending exposed soil with compost and mulch, planting exposed areas as soon as possible, and armoring outfall areas.
- Surrounding landscaped areas should be inspected regularly and possible sediment sources controlled immediately.
- Installations can be monitored for adequate or designed minimum infiltration rates by observing drainage immediately after heavier rainstorms for standing water or infiltration tests using ASTM C1701.
- Clean permeable pavement surfaces to maintain infiltration capacity at least once or twice annually following recommendations below.
- Utility cuts should be backfilled with the same aggregate base used under the permeable paving to allow continued conveyance of stormwater through the base, and to prevent migration of fines from the standard base aggregate to the more open graded permeable base material (Diniz, 1980).
- Ice buildup on permeable pavement is reduced and the surface becomes free and clear more rapidly compared to conventional pavement. For western Washington, deicing and sand application may be reduced or eliminated and the permeable pavement installation should be assessed during winter months and the winter traction program developed from those observations. Vacuum and sweeping frequency will likely be required more often if sand is applied.

6

6.3 Permeable Pavement

6.3.4 permeable paving performance

Maintenance recommendations for specific permeable paving surfaces.

Porous asphalt and pervious concrete

- Clean surfaces using suction, sweeping with suction or high-pressure wash, and suction (sweeping alone is minimally effective). Hand held pressure washers are effective for cleaning void spaces and appropriate for smaller areas such as sidewalks.
- Small utility cuts can be repaired with conventional asphalt or concrete if small batches of permeable material are not available or are too expensive.

Permeable pavers

- ICPI recommends cleaning if the measured infiltration rate per ASTM C1701 falls below 10 inches per hour (Smith, 2011).
- Use sweeping with suction when surface and debris are dry 1-2 times annually (see next bullet for exception). Apply vacuum to a paver test section and adjust settings to remove all visible sediment without excess uptake of aggregate from paver openings or joints. If necessary, replace No 8, 89 or 9 stone to specified depth within the paver openings. Washing or power washing should not be used to remove debris and sediment in the openings between the pavers (Smith, 2000).
- For badly clogged installations, wet the surface and vacuumed aggregate to a depth that removes all visible fine sediment and replace with clean aggregate.
- If necessary, use No 8, 89 or 9 stone for winter traction rather than sand (sand will accelerate clogging).
- Pavers can be removed individually and replaced when utility work is complete.
- Replace broken pavers as necessary to prevent structural instability in the surface.
- The structure of the top edge of the paver blocks reduces chipping from snowplows. For additional protection, skids on the corner of plow blades are recommended.
- For a model maintenance agreement see

Permeable Interlocking Concrete Pavements (Smith, 2011).

Plastic or concrete grid systems

- Remove and replace top course aggregate if clogged with sediment or contaminated (vacuum trucks for stormwater collection basins can be used to remove aggregate).
- Remove and replace grid segments where 3 or more adjacent rings are broken or damaged.
- Replenish aggregate material in grid as needed.
- Snowplows should use skids to elevate blades slightly above the gravel surface to prevent loss of top course aggregate and damage to plastic grid.
- For grass installations, use normal turf maintenance procedures except do not aerate. Use very slow release fertilizers if needed.

6.3.4 Permeable Paving Performance Infiltration

Initial research indicates that properly designed and maintained permeable pavements can virtually eliminate surface flows for low to higher intensity storms common in the Pacific Northwest, store or significantly attenuate subsurface flows (dependent on underlying soil and aggregate storage design), and provide water quality treatment for nutrients, metals and hydrocarbons. A six-year University of Washington permeable pavement demonstration project found that nearly all water infiltrated various test surfaces (included Eco-Stone, Gravelpave and others) for all observed storms (Brattebo and Booth, 2003). Observed infiltration was high despite minimal maintenance conducted.

Initial infiltration rates for properly installed permeable pavement systems are high. Infiltration rates for in-service surfaces decline to varying degrees depending on numerous factors including initial design and installation, sediment loads, and maintenance.

6.3.4 permeable paving performance**Porous asphalt:**

- highest initial rate (new installation): 1750 in/hr.
- lowest initial rate (new installation): 28 in/hr.
- highest in-service rate: 1750 in/hr. (1 year of service, no maintenance)
- lowest in-service rate: 13 in/hr. (3 years of service, no maintenance)

Pervious concrete:

- highest initial rate: 1438.20 in/hr.
- lowest in-service rate: 240 in/hr. (6.5 years of service, no maintenance)

Note: City of Olympia has observed (anecdotal) evidence of lower infiltration rates on a sidewalk application; however, no monitoring data has been collected to quantify observations (personal communication Mark Blosser, August 2004).

Permeable pavers:

- highest initial infiltration rate (new installation): 1158.75 cm/hr.
- lowest initial rate (new installation): 317.75 cm/hr.
- highest in-service rate: 2000 in/hr.
- lowest in-service rate: 0.58 in/hr.

Clogging from fine sediment is a primary mechanism that degrades infiltration rates. However, the design of the permeable surface (i.e., percent fines, type of aggregate, compaction, asphalt density, etc.) is critical for determining infiltration rates and performance over time as well.

Various levels of clogging are inevitable depending on design, installation, and maintenance and should be accounted for in the long-term design objectives.

European research examining several permeable paver field sites estimates a long-term design rate at 10.8 cm per hour (4.25 inches per hour) (Borgwardt, 1994). David Smith from the ICPI, however, recommends using a conservative 25 cm/hr. (10 in/hr.) infiltration rate for the typical 20-year life span of unmaintained permeable paver installations (Smith, 2011).

The lowest infiltration rate reported for an in-service permeable paving surface that was properly installed was approximately 0.58 in/hr. (Uni Eco-Stone parking installation).

Results from the three field studies evaluating cleaning strategies indicate that infiltration rates can be improved to various degrees. Permeable paver research in Ontario indicates that infiltration rates can be maintained for Ecostone with suction equipment. Standard street cleaning equipment with suction may need to be adjusted to prevent excessive uptake of aggregate in paver cells (Gerrits and James, 2001). Washing should not be used to remove debris and sediment in the openings between pavers. Suction can be applied to paver openings when surface and debris are dry.

Street cleaning equipment with sweeping and suction perform adequately on moderately degraded porous asphalt while high pressure washing with suction provides the best performance on highly degraded asphalt (Dierkes, Kuhlmann, Kandasamy and Angelis, 2002 and Balades, Legret and Madiec, 1995). Sweeping alone does not improve infiltration on porous asphalt.

Water Quality

Research indicates that the pollutant removal capability of permeable paving systems is very good for constituents examined. Laboratory evaluation of aggregate base material in Germany found removal rates of 89-98 percent for dissolved lead, 74-98 percent for dissolved cadmium, 89-96 percent for dissolved copper, and 72 -98 percent for dissolved zinc (variability in removal rates depended on type of stone). The same study excavated a 15-year old permeable paver installation in a commercial parking lot (see figure 6.3.27) and found no significant concentrations of heavy metals, no detection of polycyclic aromatic hydrocarbons (PAHs), and elevated, but still low concentrations of mineral oil in the underlying soil (Dierkes et al., 2002).

6

6.3 Permeable Pavement

6.3.4 permeable paving performance

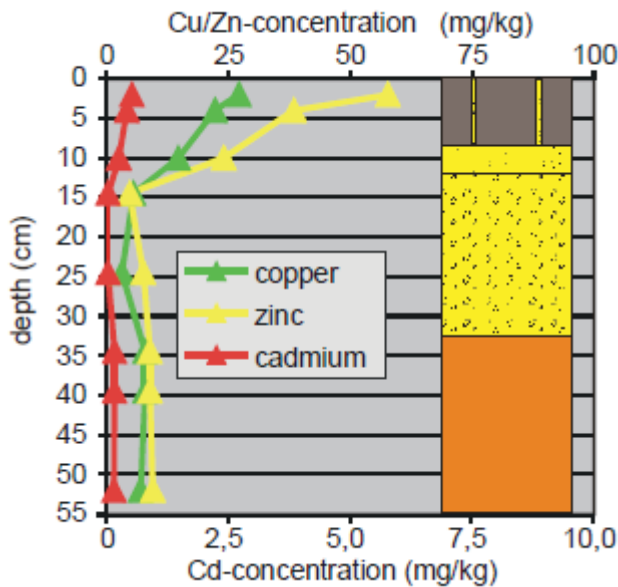

figure 6.3.24

Metal concentrations under a 15-year old permeable paver installation at a retail center in Germany. Source: Dierks et al., 2002

Pratt, Newman and Bond (1999) recorded a 97.6 percent removal rate for automobile mineral oil in a 780-mm deep permeable paver section in England. Removal was attributed largely to biological breakdown by microbial activity within the pavement section, as well as adhesion to paving materials (Pratt, Newman and Bond, 1999).

A study in Connecticut compared driveways constructed from conventional asphalt and permeable pavers (UNI group Eco-Stone) for runoff depth (precipitation measured on-site), infiltration rates, and pollutant concentrations. The Eco-Stone driveways were two years old. During 2002 and 2003 mean weekly runoff depth recorded for asphalt was 1.8 mm compared to 0.5 mm for the pavers. Table 6.3.3 summarizes pollutant concentrations from the study (Clausen and Gilbert, 2003).

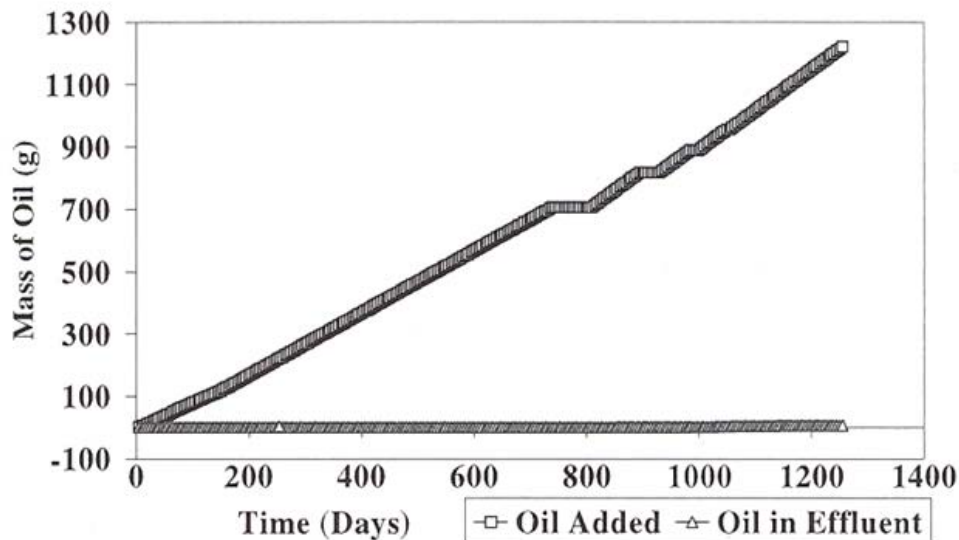

figure 6.3.25

Mass of motor oil added (ascending line) and oil in effluent (flat line) for permeable pavement experiments in England. Removal efficiency was approximately 99 percent.

Source: Pratt, Newman and Bond, 1999

In the Puget Sound region, a six-year permeable parking lot demonstration project conducted by University of Washington found toxic concentrations of dissolved copper and zinc in 97 percent of the surface runoff samples from an asphalt control parking stall. In contrast, dissolved copper and zinc in 31 of 36 samples from the permeable parking stall (that produced primarily subsurface flow) fell below toxic levels and a majority of samples fell below detectable levels. Motor oil was detected in 89 percent of the samples from the surface flow off the asphalt stall. No motor oil was detected in any samples that infiltrated through the permeable paving sections (Brattebo and Booth, 2003).

table 6.3.3 Mean weekly pollutant concentration in stormwater runoff, Jordan Cove, CT

Variable	Asphalt	Paver
TSS	47.8 mg/L	15.8 mg/L
NO ₃ -N	0.6 mg/L	0.2 mg/L
NH ₃ -N	0.18 mg/L	0.05 mg/L
TP	0.244 mg/L	0.162 mg/L
Cu*	18 ug/L	6 ug/L
Pb*	6 ug/L	2 ug/L
Zn*	87 ug/L	25 ug/L

Adopted from Clausen and Gilbert, 2003

*Total or dissolved form not reported.

THIS PAGE
INTENTIONALLY
LEFT BLANK

6.4 Urban and Suburban Trees

Trees in developed areas provide several environmental, aesthetic, and economic benefits. In an extensive urban tree study of five cities across the U.S., McPherson et al. (2005) found that the benefits from trees, including energy conservation, air quality, carbon sequestration, increased property values, and stormwater management, significantly outweighed the costs of installation and maintenance. The stormwater reduction benefits (dollars per gallon saved on construction and maintenance of retention or detention structures) ranged from approximately \$37,000 to \$496,000 annually.

“The stormwater reduction benefits of trees ranged from approximately \$37,000 - \$496,000 annually.”

Increasingly, jurisdictions are providing stormwater volume reduction and peak flow attenuation credits for trees. Trees reduce surface flow from impervious and compacted landscape areas by intercepting and storing precipitation until evaporated, directing intercepted precipitation from foliage and branches to the trunk and surrounding soil, and by improving stormwater retention with extensive root systems that penetrate soil, build soil structure, and provide conduits for infiltration.

6.4.1 Applications

This section examines individual trees protected or placed in the urban, suburban, or other developed settings. Properly placed new trees and protected existing trees can intercept precipitation and reduce associated surface flow on residential, urban, and commercial streets, commercial and urban parking lots, and urban sidewalks and promenades.

For native soil and vegetation protection and management information, see Chapter 4: Vegetation and Soil Protection and Reforestation.

6.4.2 Site Assessment and Design

Planting new or preserving existing trees to achieve optimum vigor, crown structure, and life span in the urban environment is challenging. Crown growth

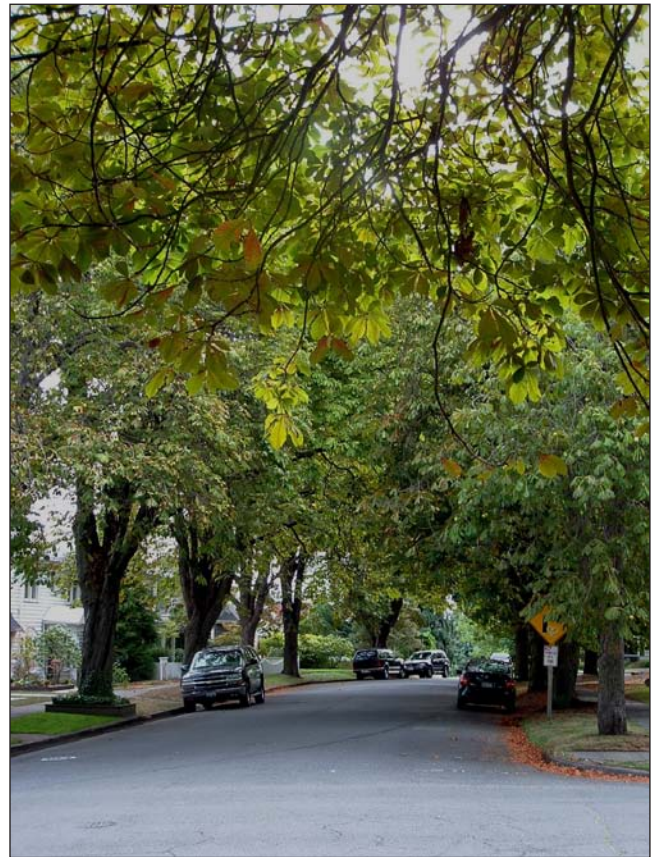

figure 6.4.1

Urban tree canopy.

Source: Photo by Colleen Owen

can be restricted by adjacent structures. Soils in developed areas are often highly compacted and inhibit root penetration, and soil volume is often limited for supporting adequate root structure. And while several factors may inhibit urban tree health (e.g., increased temperatures and associated water demand, atmospheric pollutants, salt and deicers, and physical damage), inadequate underground rooting space is a primary factor for impaired growth and premature mortality of trees in developed areas (Lindsey and Bussuk, 1992; Grabosky and Gillman, 2004). Additionally, trees are typically surrounded by impervious surface, limiting soil moisture, nutrients, and gas exchange.

6

6.4 Urban Trees

6.4.2 assessment & design

Four broad concepts are considered throughout the recommendations below:

1. Larger mature trees provide more stormwater (and other) benefits than small trees.
2. Evergreen trees provide greater stormwater management benefit than deciduous trees.
3. Adequate soil volume and quality are critical design elements for trees to reach mature size.
4. If stormwater is directed to the tree planting area, too much water can kill a tree faster than too little water and special attention to adequate drainage is necessary for development of a healthy tree (Urban, 2008).

The following design section is divided into five parts: site assessment, drainage, soil strategies, selecting trees, and protecting existing trees. Appendix 2 provides a matrix of various trees and some of the characteristics important to consider for successful placement. Some of the specific techniques for successfully placing and managing trees in the urban environment are beyond the scope of this document. Engaging qualified designers (landscape architects, certified arborists, etc.) at the early stages of design is important for successful placement and management of trees. Other valuable resources include: Matheny, N., & Clark, J.R. (1989), *Trees and development: A technical guide to preservation of trees during land development*; and James Urban (2008) *Up by Roots: Healthy Soils and Trees in the Built Environment*.

6.4.2.1 Site assessment and planning

Placing and retaining healthy trees requires space and investment. Realizing the substantial benefits of mature trees requires engaging the designer from planning through construction phases, whether new construction or a retrofit. Above and below ground site assessment to inform soil strategies and species selection is important to grow healthy trees and reduce potential problems with competing uses. The initial site assessment for location and type of tree should include:

- Available above ground growing space.
- Below ground root space and ground level planting area relative to pavement, buildings, and utilities.

- Type of soil and availability of water.
- Overhead wires.
- Vehicle and pedestrian sight lines.
- Proximity to paved areas and underground structures.
- Proximity to property lines, buildings, and other vegetation.
- Prevailing wind direction and sun exposure.
- Maintenance.
- Additional environmental, economic, and aesthetic functions, such as shade (reduced heat island effect), windbreak, privacy screening, air quality, and increased property value.

Many of the key decisions for designing with trees in the urban and suburban setting will depend on the existing soil conditions. Soil analysis for trees should include: understanding historic uses, extent and result of disturbances, soil texture, compaction, permeability, barriers and interfaces in the soil profile, and chemical characteristics (Urban, 2008). Urban soils are often degraded from construction activities. If the existing soil or structural soils (see Section 6.4.2.3: Soil strategies) are used as the planting material, particular attention should be given to soil pH, which is often high due to concrete/construction debris and can cause nutrient deficiency and other problems. The ideal pH for most trees is 5 to 6.5 (Day and Dickinson, 2008). Once the basic site assessment and soil analysis is compiled, the following guidelines can be applied for site layout to incorporate trees (Urban, 2008):

- Plant in the best or appropriate places first with the highest quality soils and adequate soil volume with the appropriate tree species.
- Design for larger planting spaces by reducing pavement through well-designed vehicle and pedestrian infrastructure, and by designing with the circulation patterns. For example, design rectangular planting areas with the long axis parallel to the street and use techniques for increasing soil and rooting volume (see Section 6.4.2.3: Soil Strategies).

**figure 6.4.2**

Example of trunk flare.
Source: Curtis Hinman

- Do not pave or restrict within the projected area of the mature tree's trunk flare. The trunk flare is the transition area between the base of the trunk and root crown and is often 2-3 times the trunk diameter (trunk diameter measured at 4 feet above ground).
- Use pervious pavement for hard surfaces surrounding trees to allow gas exchange and increase soil moisture.
- Protect the tree and tree pit soil from surrounding uses (e.g., pedestrians, vehicles, ongoing maintenance activities) in the development (see Section 6.4.2.4: Soil Strategies for more detail).

6.4.2.2 Drainage

Without stormwater directed to the planting area

Design for appropriate drainage (saturated conditions can create more and more expensive problems than dry conditions). If water is not directed to the tree pit from surrounding impervious areas, seasonally high groundwater is below the bottom of the tree planting pit, and the tree pit volume is adequate to support a healthy mature tree, under-drains may not be needed because: 1) significant precipitation volume that would otherwise fall on that area is intercepted and

evaporated; and 2) the reduced volume that enters the enlarged area of the tree pit can be slowly infiltrated in subgrade soils with lower permeability. However, careful assessment of subgrade soils, groundwater levels, and site drainage patterns should be used to determine soil water and optimum tree planting conditions. In general, the tree planting pit or reservoir in the tree rooting zone (18-24 inches) and above under-drain (if installed) should drain down within 48 hours to encourage aerobic conditions and good root distribution through planting pit for many tree species (Bartens, 2009). However, there are species more tolerant of prolonged saturated conditions. If the site assessment determines there is potential for extended ponding or dense, compacted soils are present, consult the designer for appropriate drainage strategies and arborist for appropriate tree species. Where additional drainage is necessary several strategies are available, including:

- Where subgrade soils have low infiltration rates install under-drain(s) with an accessible control structure to adjust flow and soil water conditions as needed. This is an inexpensive backup compared to retrofitting planting areas to ensure proper drainage. See "Under-drains" in Section 6.1.2.2 for more detail on under-drain design.

6

6.4 Urban Trees

6.4.2 assessment & design

- Elevate drain to maintain an unsaturated area in the upper 18-24 inches of the soil profile, where most roots are located, and a wetter area below the drain for improved retention and available soil moisture for the tree in drier periods.
- In wetter areas where under-drains are not feasible, mound the planting area or plant at top of the slope if possible, install dry wells (preferably with connection to more permeable soils), or use sand/gravel-filled percolation trenches.
- In dry sites, plant in low areas, improve water holding capacity of soil (and compost and mulch), and flatten slopes.

With stormwater directed to planting area

With adequate subgrade infiltration rates, tree planting areas can be used to collect stormwater from small contributing areas. Careful assessment of subgrade soils, groundwater levels, and site drainage patterns should be used to determine soil water and optimum tree planting conditions. Too much water can kill trees (Urban, 2008).

Increasing the volume of soil and preventing compaction of existing soil in the tree planting areas for roots also increases the volume for stormwater storage and treatment. Structural soils, rigid cell systems, and root trenches are examples of techniques to significantly increase storage volume under paved areas (see Increasing soil and rooting volume under Section 6.4.2.3: Reducing soil compaction). Furthermore, these and other techniques can be used to connect tree pits for individual trees and employ much or all of subsurface area under a sidewalk as potential storage.

If stormwater from adjacent impervious area is directed to the tree pit, in many ways flow control considerations are similar to bioretention. Adequate drain-down is important for tree health. Limited research in this area indicates that the soil reservoir should drain down within 48 hours to encourage good root distribution through the planting pit (Bartens, 2009). However, there are species more tolerant of prolonged saturated conditions. If the site assessment determines there is

potential for extended ponding, or dense, compacted soils are present, consult the designer for appropriate drainage strategies. In poor-draining or compacted urban soils, this may require an under-drain (see “Under-drains” in Section 6.1.2.2 for details on under-drain design). Discharge from the under-drain should be to an approved location.

Calculating the appropriate amount and directing stormwater to the tree planting area are some of the more important design considerations for managing adjacent impervious area in tree pits. Several strategies for directing stormwater to the tree pit are possible depending on flow control or water quality treatment goals, setting, and local regulations:

- Permeable pavement
- Sloped sidewalks
- Curb inlets
- Roof drains

6.4.2.3 Reducing soil compaction and protecting new and existing trees

Protecting new and existing trees and minimizing soil compaction to maintain infiltration and adequate growing characteristics in the built environment, and particularly urban areas, requires careful planning. The designer must pay close attention to construction sequencing and material staging from the planning through construction phases as well as protection once the project is completed. Particularly important is protecting soils from compaction and contamination in tree planting areas. Protection techniques include:

- Clearly mark protection areas, soil storage/staging areas, existing tree protection areas, etc. on plans and on site.
- Review plans with the construction foreman and crews prior to construction.
- Coordinate throughout construction process with contractor to minimize compaction and coordinate soil storage and reuse.
- Install robust fencing and signage declaring protection objectives and penalties for violating protected areas. Fencing will likely include sediment control combined with larger barriers to prevent entry.
- Where construction operations unavoidably

require temporary access over tree root zones or other soil protection areas, provide protection as follows:

- » *For foot access or similar light surface impacts*, apply a 6-inch layer of **arborist wood chip mulch** and water regularly to maintain soil moisture, control erosion, and protect surface roots.
- » *For any vehicle or equipment access*, apply a minimum 1-inch steel plate or 4-inch thick timber planking over 2-3 inches of arborist wood chip mulch, or a minimum ¾-inch plywood over 6-8 inches of mulch to protect roots and root zone soil from disturbance or compaction. Protect tree trunks and above-ground root flare with solid barriers such as plywood boxes.

In tree planting areas where soil is disturbed from previous activity or from current construction, depth of compaction should be assessed to determine appropriate mitigation strategies. If heavy machinery accesses the tree planting areas when soils are wet, compaction (that could inhibit root penetration) may reach depths of 2-3 feet (Balousek, 2003, and Matheny and Clark, 1998). Surficial compaction can be mitigated by tilling (effective to approximately 6 inches) and incorporating compost. For deeper compaction, double spading, excavator turning, sub-soiling or trench sub-soiling with the addition of compost is necessary to reduce density. Reducing surface and deep compaction should only be done during drier periods and when soil is **friable**.

Long-term protection is necessary to reduce compaction of the tree planting area. Tree grates have been a common strategy to protect soil around trees; however, grates are expensive, difficult to enlarge as the tree grows, and the elevation of the root ball must be below the elevation of the pavement (in poor draining soils this can kill the tree). Accordingly, tree grates are not a preferred strategy. Better strategies to protect soil in tree planting areas include:

- Mulch tree planting bed with 2-4 inches of arborist wood chips (mixed green and woody chips from

tree-trimming operations). Keep the mulch 1 inch back from the trunk and replenish every 1-3 years. Arborist chip are the preferred mulch because it maintains surface porosity, conserves moisture, controls weeds, and slowly replenishes the soil while supporting beneficial mycorrhizal fungi development. Coarse compost can also be used to improve poor soils, but it does not suppress weeds as well. Layering compost at the soil surface with wood chips on top for weed control is an effective strategy. Bark mulch does not improve the soil as much as arborist chips, and finely ground bark should be avoided because it can reduce air and water penetration (Lindsey and Bussuk, 1992; Seattle Public Utilities, 2009 and 2011).

- Use wheel stops to restrict vehicle access in roadside applications.
- Install low fencing, curbs, or other barriers to exclude excessive foot traffic (see figure 6.4.3).

Reducing compaction around existing trees

Reducing compaction where tree roots are present will often require consulting with an arborist, specialized equipment, and possibly significant expense. Accordingly, good soil assessment is necessary to determine extent of compaction and effective remedies that protect larger roots from mechanical damage. Soil probes and test pits to examine the soil profile and level of compaction are the most effective tools for compaction analysis and locating large roots for protection. Ground penetrating radar can also be used (Urban, 2008). Techniques for reducing compaction in a tree root zone include (Urban, 2008):

- Air and hydro excavation: air excavation uses compressed air to blow soil apart and hydro excavation uses high pressure water to erode soil.
- Vertical mulching: uses a series of holes in the compacted soil that are 5-6 inches in diameter and 6-9 inches deep. Holes are filled with compost or compost and expanded shale, clay, or slate where pedestrian traffic is present.
- Radial trenching: trenches 5-6 inches wide and 6-12 inches deep are excavated with an air

6

6.4 Urban Trees

6.4.2 assessment & design



figure 6.4.3

Barrier (low fencing) to prevent access and soil compaction.
Source: Photo by Shane DeWald

excavation tool and vector truck. The trenches extend radially to the edge of the tree canopy and are filled with compost or compost and expanded shale, clay, or slate where pedestrian traffic is present.

If compaction is not limiting root growth, compost or biologic amendments (e.g., compost tea, humic acid) can be used to improve tree health. Biologic amendments are likely more effective when used with the above techniques to reduce compaction. A 2-3-inch compost mulch should be applied over the root zone in conjunction with the biologic amendments (Urban, 2008).

6.4.2.4 Soil strategies to improve rooting volume and tree health

Urban soils are often highly compacted and inhibit root penetration, and soil volume is often limited for supporting adequate root structure. Several factors may inhibit tree health in developed areas (increased temperatures and associated water demand, atmospheric pollutants, salt and deicers, and physical damage); however, inadequate underground rooting space is a primary factor for impaired growth and premature mortality of city trees (Lindsey and Bussuk, 1992; Grabosky and Gillman, 2004).

Soil depth and volume

Urban (2008) recommends a minimum depth for planting soil of 30-48 inches. This depth should extend for a 10-foot radius around tree in lawn areas.

Recommendations for adequate soil volume vary significantly for trees planted in conventional soil. Lindsey and Bussuk (1992) recommend approximately 8 cubic feet per 10 square feet of **crown projection** for a typical silt loam soil to provide the volume necessary to support adequate root structure. Urban (2008) recommends determining soil volume by soil type, available water, and tree size (crown projection or trunk diameter at breast height). At a rate of 1.0-3.0 cubic feet of soil per 1 square foot tree crown area, depending on irrigation schedule. For soil that is reliably irrigated, use 1.0 cubic foot and 3.0 cubic feet for non-irrigated trees in drier areas.

The volume of soil available for supporting tree growth varies depending on the tree soil system. For rigid cell systems that provide soil volume under pavement (see below for details), use 90 percent. Structural soils are mostly larger aggregate for structural support mixed with approximately 20 percent soil to support plant growth. Accordingly, structural soils designed for high compaction have less soil and will not support as large a tree canopy as a loam soil at lower compaction per unit volume (Urban, 2008).

Soil amendments

Initial site assessment should provide necessary information on soil texture, compaction, permeability, and chemical characteristics of soil. If possible, stockpile and reuse existing soils for tree planting. Relatively fine-grained soils can be reused and support healthy tree growth. For adequate drainage and tree health, Urban (2008) recommends avoiding topsoil that has more than 35 percent clay, 45 percent silt, or 25 percent fine sand. Loam, sandy loam, and sandy clay loam are good textural classifications for supporting healthy tree growth (Urban, 2008).

If stormwater is directed to the tree planting area, a designed soil mix may be necessary to achieve adequate infiltration and drain-down characteristics. The water holding, organic matter, and chemical characteristics of the soil must be compatible with the water needs and other cultural requirements of the tree.

Several materials are available to amend existing soils or design a specific soil mix. Mineral soil amendments alter soil texture and improve infiltration and water holding characteristics. Common materials used in tree planters and planting areas include: sand, expanded shale, clay and slate, and diatomaceous earth (see Urban, 2008 for detailed descriptions for using mineral amendments).

Disturbed urban soils are often low in organic matter. Biologic and organic amendments are used to improve organic matter content, infiltration capability, nutrient availability, soil biota, and cation exchange capacity.



figure 6.4.4

The same species of tree planted at the same time, but the trees on the left have more soil volume for root growth.

Source: Photo courtesy of Nina Bassuk

Biologic amendments include mycorrhizal fungi spores, kelp extracts, humic acids, organic fertilizers, and compost tea. If tree planting soil is poor quality, biologic amendments generally only offer a temporary improvement for tree growth. The most common and effective amendment for soils deficient in nutrients, water-holding capacity, and permeability is organic compost. For tree planting areas, 10-15 percent compost by volume is recommended for soil profiles deeper than 12 inches. Up to 25-35 percent compost by volume can be incorporated into the top 6 inches of the soil profile to promote formation of new topsoil (Urban, 2008)

Increasing soil and rooting volume

There are four primary strategies to improve the subsurface environment for trees and provide stormwater infiltration in urban settings:

1. Rigid, load-bearing cells that are filled with uncompacted soil.
2. Structural soils.
3. Creating root paths.
4. Connecting to adjacent soil volume (Urban, 2008).

6

6.4 Urban Trees

6.4.2 assessment & design

figure 6.4.5

This Shoreline, WA installation uses a rigid cell system placed under the sidewalk to increase soil volume and quality for street trees. The project combines the tree planting system with a permeable pavement sidewalk and bioretention between the sidewalk and the street.

Source: Photo and graphic courtesy of Otak



Rigid cell systems

Rigid cell systems are modular frames (base and pillar) with a deck that supports the pavement above and creates large spaces for uncompacted soil and tree roots. SilvaCell is a common type of rigid load-bearing system for trees. The decks are often designed for **AASHTO H-20** loading (see figure 6.4.6). Many utilities can be installed within and through the cells; however, utilities require planning and careful consideration. Many types of soil can be used to fill the cells for a rooting media, including imported soils designed for the specific tree or excavated soils (including heavier dense soils with higher clay content) amended with compost if necessary (ASLA, 2010). An advantage with rigid cells is that much of the volume created by the cell is available for soil.

Structural soils

Structural soils provide a porous growth media and structural support for sidewalks and street edges. Cornell University (CU Structural Soil™) developed one of the first structural soils in the early 1990's and others have since developed load-bearing growth media (e.g., Stalite). Structural soils are a mix of mineral soil (typically a loam or clay loam with at least

20 percent clay for adequate water and nutrient holding capacity) and coarse aggregate (typically uniformly graded $\frac{3}{4}$ to 1½-inch angular crushed stone) that, after compaction, maintains porosity (typically 25-30 percent) and infiltration capacity (typically >20 in/hr.). Current research and installation experience suggests the following when designing with structural soil:

- Soil volume: 2 cubic feet for every 1 square foot of crown projection (mature tree). Structural soil can be used under all or part of the paved surfaces adjacent to trees to provide the necessary soil volume. Where structural soil is placed adjacent to open graded base aggregate, geotextile should be used to prevent migration of the fine aggregate in the structural soil to the more open graded material (Bassuk, 2005).
- Soil depth: 24 inches (minimum) to 36 inches (recommended) (Bassuk, 2005).
- Compaction: 95 percent proctor (Bassuk, 2005).
- Tree pit opening: if the tree pit opening is at least 5 feet x 5 feet, a well-drained top soil can be used in the planting area. If the opening is smaller, structural soil can be used immediately under and up to the root ball (see figure 6.4.7) (Bassuk, 2005).

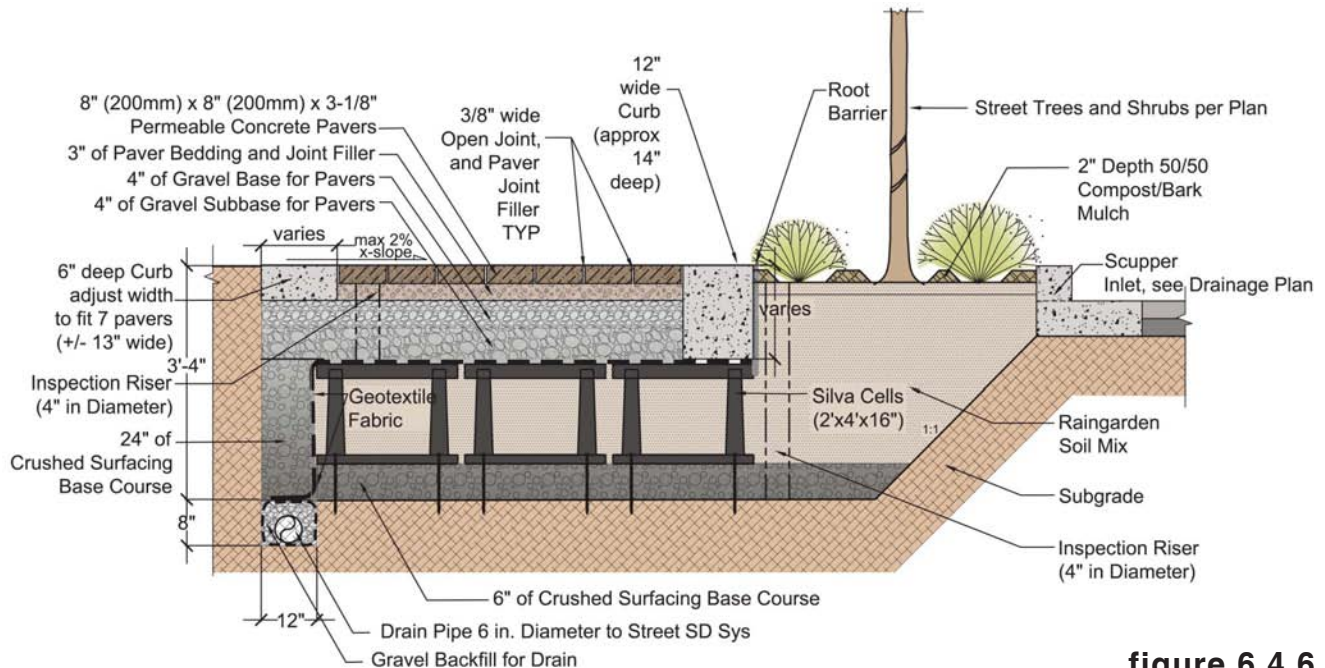

figure 6.4.6

Silva Cell with raingarden and permeable pavers example detail
 Source: Graphic courtesy of Otak

- Available soil: the structural aggregate uses approximately 80 percent of the available space; therefore, approximately 20 percent of the total planting volume is available soil to support tree growth.
- Planters with impervious walls: openings filled with uncompacted soil can be used to allow roots to access surrounding structural soil (Bassuk, 2005).
- Tree species: Use species that are tolerant of well-drained soil and periodic flooding.
- Drain down: Structural soil reservoir should drain down within 48 hours to encourage good root distribution through planting pit (Bartens, 2009).

Contact authorized distributors and see Day and Dickinson, 2008 for guidelines on specific structural soil products.

Many structural soils are proprietary mixes distributed through licensed providers. Sand-based Structural Soil (SBSS) is an urban tree planting system that is not proprietary. SBSS consists of a uniform gradation of medium to coarse sand (typically 30 inches deep) mixed with compost (2-3 percent by volume) and loam to achieve approximately 8-10 percent silt by volume. In general, the saturated hydraulic conductivity should be approximately 4-6 inches per hour (personal communication, Bob Pine, 2012). The uniformly graded sand maintains porosity and infiltration capacity when compacted; however, the load-bearing capacity of the mix is reduced due to the uniform particle size. Accordingly, crushed stone is used between the sand and surface wearing course (see figure 6.4.8). A sub-surface irrigation port that can be accessed from the surface of the tree pit or drip irrigation should

6

6.4 Urban Trees

6.4.2 assessment & design



figure 6.4.7

Structural Soil with porous asphalt parking.

Source: Photo courtesy of Nina Bassuk

Typical parking lot island and structural soil section (below).

Source: Graphic courtesy of Cornell University

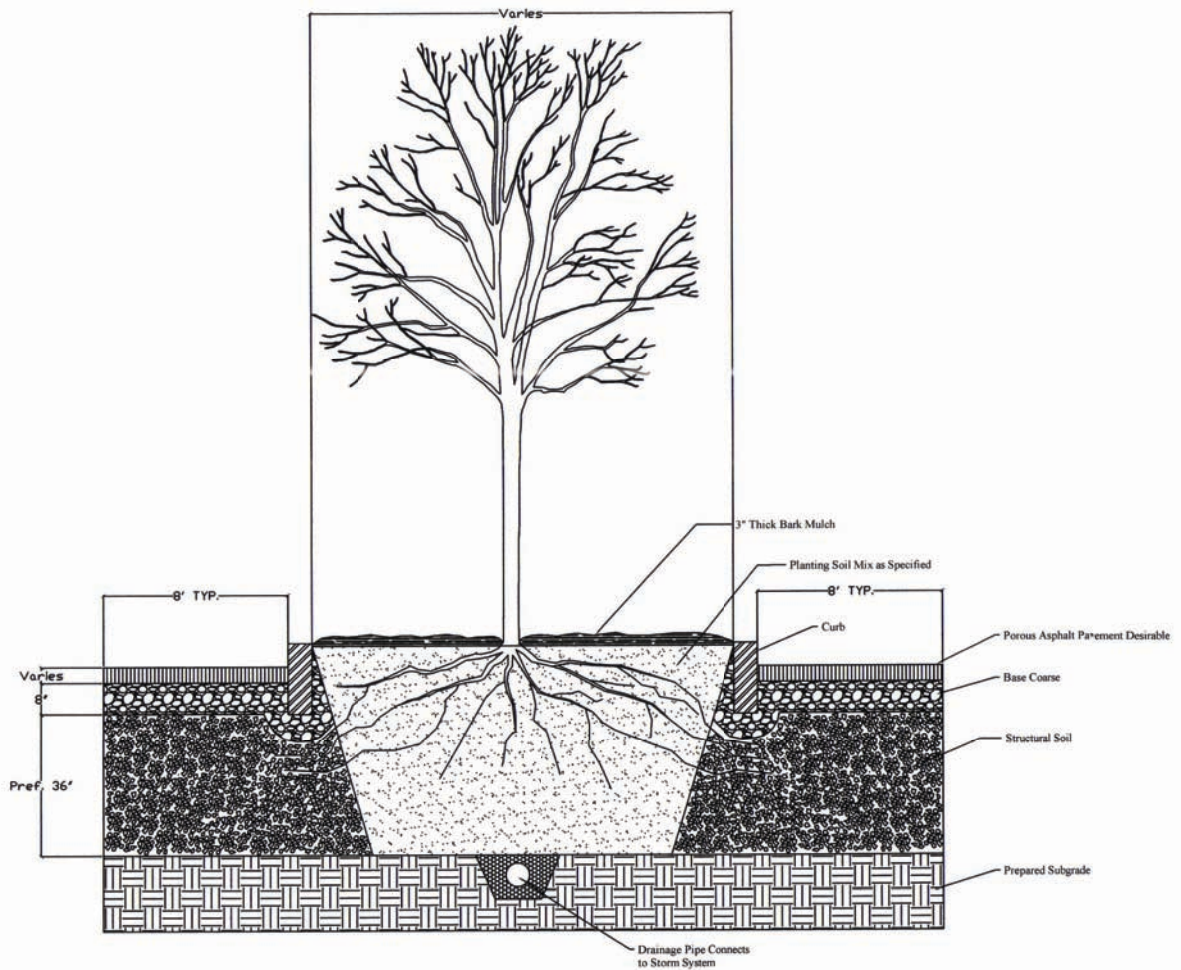

BARE ROOT TREE IN TYPICAL PARKING LOT ISLAND

be incorporated for initial establishment of trees and subsequent irrigation if necessary (ASLA, 2010). As with all urban tree systems, excess water and anaerobic soil conditions can impair or kill trees and sub-surface drainage layers or under-drains should be considered to manage soil moisture on subgrades with low permeability (see Section 6.4.2.2 for more detail on drainage and under-drains). Structural soils can be used in conjunction with permeable pavement (Haffner, 2007).

Creating root paths

Root paths are a technique to connect planting areas, interconnect tree roots, or guide roots out of confined areas to soil under pavement or adjacent to paved area that has the capability to support root growth (e.g., uncompacted, adequately drained loams). The actual root paths add only small amounts of rooting volume. The path trenches are typically 4 inches wide by 12 inches deep and filled with a strip drain board and topsoil. Root paths are excavated with a standard trenching machine, placed approximately 4 feet on center, and compacted with a vibrating plate compactor to retain subgrade structural integrity for pavement. The trenches should be extended into the

tree planting pit a minimum of 1 foot and preferably within a few inches of the tree root ball (Urban, 2008).

Connecting to adjacent soil volume

Soil trenches are used to increase soil and root volume, connect to other tree planting areas, and importantly, connect to larger areas with soil that have the capability to support root growth (e.g., uncompacted, adequately drained loams). The trenches are typically 5 feet wide with sloped sides for structural integrity and filled with topsoil or a designed soil mix. The installed soil is lightly compacted (e.g., 80 percent Proctor) with a gravel base placed on top of the soil to increase support for the sidewalk. The sidewalk is reinforced with rebar and thickened to span the soil trench. The thickened portion should extend a minimum 18 inches onto the adjacent compacted subgrade. An under-drain may be necessary depending on subgrade soil with low infiltration rates and if stormwater is directed to the tree planting area (see Section 6.4.2.2 and consult with the designer for drainage requirements). Provide subsurface irrigation conduit preferably from stormwater or harvested water in areas with less than 30 inches of annual precipitation (Urban, 2008).

figure 6.4.8

Sand-based structural soil section.
Source: Robert Pine & Co.

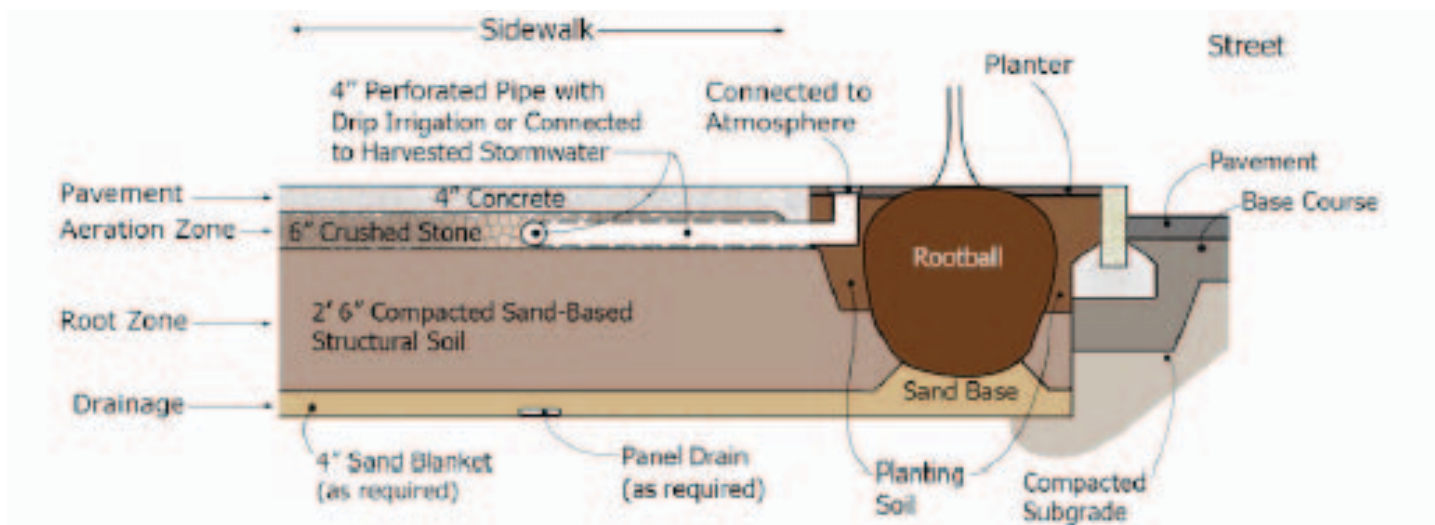

6

6.4 Urban Trees

6.4.3 tree selection / 6.4.4 planting size 6.4.5 spacing / 6.4.6 Performance

6.4.3 Tree selection

Local jurisdictions often have specific guidelines for the types and location of trees planted along public streets or rights-of-way. For example, most jurisdictions require minimum sight distances at intersections and setbacks of trees from street corners. Consult local regulations and design manuals for sight distances, setbacks, and other design guidelines.

Several constraints (some discussed above) limit the list of trees used in the developed environment. Urban (2008) suggests that designers, instead of simply selecting the right tree for the right place, should strive to make the place right (e.g., through appropriate street design and soil enhancement) then select the right tree for that place.

Several resources, including books, web-based materials, and local experts (arborists, horticulturalists, etc.) are available to provide cultural and tree physical characteristics for proper tree selection. However, the most important selection resource is local knowledge and observing successful tree installations and failures. Primary tree selection criteria include:

- The extent and growth pattern of the root structure in the context of adjacent paved areas or underground utilities.
- Cultural requirements including temperature hardiness, soil type, pH, ability to withstand wind, tolerance to drought, seasonally saturated soils and poor soils, and lighting.
- Tolerance for urban pollutants.
- Growth rate.
- Tolerance for pruning (in many developed settings, pruning may be necessary to reduce conflicts with adjacent utilities or to maintain site distances and safety).
- Deciduous or evergreen (evergreen trees intercept and evaporate more precipitation than similar size deciduous trees).
- Crown spread and density (interception and evapotranspiration increase with increasing crown size and density).
- Foliage texture and persistence.
- Longevity or life-span. Ideally a street tree will

be “long-lived”, meaning it has a life span of 100 years or more. However, the longevity of a tree will need to be balanced with other selection priorities.

Appendix 2 lists the growth pattern and appropriate site characteristics for a variety of trees appropriate for street, parking lot, residential yard, and bioretention applications.

6.4.4 Planting size

A 3-4-inch caliber tree is the optimum size for planting in the urban landscape (Urban, 2008).

The time to recover from transplant shock is approximately 6-12 months per caliber inch depending on latitude (Urban, 2008). Planting larger trees is appealing to provide a more finished appearance immediately after project completion; however, transplant shock may be longer and maintenance during recovery more extensive. In contrast, 3-4-inch trees will likely recover faster and surpass the larger planting with less initial care (Urban, 2008).

6.4.5 Spacing

Urban (2008) recommends a spacing of 30-35 feet for a single row of street trees. For two rows of trees, a minimum of 30 and preferable 50-60 feet is recommended to support adequate light for internal branches, canopy structure, and symmetry of the tree.

6.4.6 Performance

Trees reduce surface flow from impervious and compacted landscape areas by:

- Interception and evaporation: Intercepted precipitation is held until evaporated (in winter months evaporation is primarily from wind moving through the canopy) or intercepted precipitation moves from the foliage and branches to the trunk and surrounding soil.
- Infiltration: Extensive root systems penetrate soil, build soil structure, and provide conduits for infiltration.
- Transpiration: The uptake of soil moisture into the tree as part of the growth process and eventual

release through stomata (small pores) in the leaves or needles. Transpiration rates for stand-alone trees in western Washington urban settings during winter are not known and assumed to be negligible. For general context, three reported transpiration rates for the Pacific Northwest and Great Britain conifers and New Hampshire deciduous trees were 10, 15 and 25 percent respectively. These studies were conducted in summer months (Herrera, 2008).

The influence of trees on local hydrology and soil characteristics can be significant. Lindsey and Bassuk (1992) cite studies that measured transpiration rates of 35 gal/day for a tree with a 108 square foot crown and 250 gal/day for tree with a 205 square foot crown. Wullschleger (2000) measured a maximum transpiration rate of 353 lb/day and a total volume of 14,000 pounds in red maples over an 89-day study period (growing season). Bauer and Mastin (1997) found that interception and evaporation from vegetation during the winter months (approximately 50 percent) far exceeded estimates for western Washington and attributed the high rate to the large surface area provided by evergreen trees, relatively warm winter temperatures, and the **advective** evaporation of precipitation.

Most evapotranspiration studies are either in forest settings or during the warmer growing season. The following stormwater management performance for trees is based on literature for stand-alone trees in urban or suburban settings, and does not include research from forest settings. Performance studies from the forest setting provide important context, but may not be applicable given the differences in urban canopy structure, wind patterns, sun exposure, and temperatures.

Interception, evaporation and stem flow

Urban tree canopy interception is influenced by three factors (Xiao, 2000):

- Rainfall intensity, frequency and duration.
- Tree species and architecture: deciduous or evergreen and stem orientation.

- Other meteorological factors: including temperature, relative humidity, solar radiation, and wind speed that control the rate at which water is evaporated from the tree.

In the central California valley (similar to the Mediterranean climate), Xiao (2000) found that for a single deciduous tree, 15 percent of the annual rainfall was intercepted and evaporated. Of that, 8 percent was **stemflow** and 77 percent **throughfall**. In the same experiment for a broad-leaf evergreen tree, 27 percent went to interception and evaporation. Of that, 15 percent was stemflow and 58 percent was throughfall. Rainfall frequency was more significant for determining interception loss than rainfall rate and duration.

In a study likely most applicable to western Washington, Asadian (2009) measured interception loss for Douglas fir and western red cedar located in various urban Vancouver, BC settings during 7 storm events (October 2007 to June 2008). For the 7 events (totaling 377 mm of rainfall) interception loss ranged from 17- 89 percent. Interception loss was generally greater for western red cedar than Douglas fir. Time for throughfall to penetrate the canopy (flow attenuation) ranged from 0.2-45.5 hours for individual storms. The authors note that the high range of interception loss is greater in their study than temperate forest studies that report 9-48 percent annual interception loss. Increased temperatures in the urban setting may be a primary driver for higher evaporation rates.

Herrera Environmental Consultants (2008) reviewed the literature on tree interception loss, transpiration, and infiltration in the forest and urban settings, and recommends a 30 percent reduction in annual precipitation volume for evergreen trees due to the above processes. Tree type (deciduous or evergreen), size or canopy, and proximity to impervious surface were determined to be the primary factors driving runoff reduction attributed to trees.

See Chapter 7: Ecology Low Impact Development Design and Flow Modeling Guidance for flow reduction credits associated with new and retained trees.

6

6.4 Urban Trees

6.4.6 performance

Infiltration

Trees have the ability to penetrate and improve infiltration of relatively dense soil. Bartens et al. (2008) found that Black oak (sp.) with a coarse root structure and red maple (sp.) with more fibrous roots penetrated soils in containers with bulk densities of 1.3 and 1.6 g/cm³. In the soil with lower compaction, infiltration rates were 63 percent higher on average than controls with no plants. In the soil with higher compaction, infiltration rates were 153 percent higher than controls with no plants after approximately eight months.

6.5 Vegetated Roofs

Vegetated roofs (also known as ecoroofs and green roofs) are thin layers of engineered soil and vegetation constructed on top of conventional flat or sloped roofs. Vegetated roofs can provide multiple benefits, some of which include: extending the life of the roof membrane; improving the aesthetic of the roof-scape; increasing energy efficiency within the building; increasing biodiversity and wildlife habitat; producing urban food; and reducing stormwater volume and attenuating flows (Dunnett and Kingsbury, 2004). No two green roofs behave the same. The range of benefits for a green roof depends on a number of design factors, such as plant selection, depth and composition of soil mix, location of the roof, orientation and slope, weather patterns, and the maintenance plan.

“Vegetated roofs improve energy efficiency and air quality, reduce temperatures and noise in urban areas, improve aesthetics, extend the life of the roof, and reduce stormwater flows.”

Vegetated roofs have been mandated by many cities in Europe. The City of Toronto, Ontario is the first city in North America to mandate green roofs. Cities such as Chicago, Illinois; Washington, D.C.; Vancouver, British Columbia; and Portland, Oregon are currently considering similar measures. Cities such as Chicago; Vancouver, B.C.; Quebec City, Montreal; and Portland, Oregon offer incentives for their design and installation. The green roof industry in North America has continued to grow even in the face of economic downturns.

History

The documented existence of vegetated roofs starts in 3500 B.C. in Ireland in the form of domed ceremonial chambers. Civilizations such as the Mesopotamians, Vikings, and indigenous peoples in Asia and North America embraced this building approach. In the early to mid-twentieth Century, various early applications of vegetated roofs started to emerge. Buildings like Rockefeller Center (1932) and the residential architecture of Roland Terry in the late 1950's and 1960's on the West Coast are examples of early applications in the U.S. European cities such as

Stuttgart and Bremen, Germany and rural areas of Switzerland started exploring the idea in the early 1950's.

Single-ply membrane waterproofing technology (a critical element to the vegetated roof assembly and development) became available in the late 1960's. Organizations like the German Landscape Research, Development and Construction Society (F.L.L.) in Germany started to systematically study the elements of green roof design. This research and experimentation led to green roof specialty companies in Europe in the 1970's and 1980's. Several of these companies (e.g., Famos, Zinco, Optigtrun, Erisco-Bauder, among others) teamed up with waterproof membrane companies in North America such as Sarnafil, Garland, and Hydrotech, to provide complete green roof systems.

In 2003, 13.5 million square meters of vegetated roofs were installed in Germany (Grant et al., 2003; Peck, Callaghan, Kuhn and Bass, 1999; and Peck and Kuhn, n.d). Recent data show the North American vegetated roof industry growing at 16 to 28 percent annually. An industry survey estimated that over 4.3 million square feet of vegetated roofs were installed in North America in 2010 and approximately 8 million have been installed to date (Green Roofs for Healthy Cities, 2011). In 2010, the most prevalent type of vegetated roof was extensive, and the most common building types with vegetated roofs were institutional and commercial uses. The top three U.S. cities for vegetated roof installations in 2010 were Chicago, Washington, D.C., and New York.

6.5.1 Applications

The range of design options for vegetated roofs has dramatically increased with recent research and experimental applications. Early applications conservatively selected narrow ranges of plant species, very low slope roof decks, and very light weight assemblies. As potential functions and benefits of green roofs increased, so did the design approaches. Designs now include slopes up to and

6

6.5 Vegetated Roofs

6.5.2 design



figure 6.5.1

Commercial vegetated roof in Seattle, WA
Source: Curtis Hinman

including completely vertical applications (known as living walls), depths appropriate for food production, and weights appropriate for phytoremediation, allowing green roofs to perform many functions simultaneously. The scope and intensity of green roof research and experimentation is accelerating. Every year new green roof systems and elements are brought to the market.

6.5.2 Design

Because of their location, vegetated roofs typically require more planning and coordination to implement than ground-level landscaping. For new construction, a critical path approach is highly recommended to establish the sequence of tasks to be carried out during construction of the system. New construction involves many trades, each with its particular role and potential conflicts during installation of the vegetated roof. For example, construction may require coordination among a general contractor, landscape contractor, roofing contractor, leak detection specialist, irrigation specialist, HVAC contractor, and construction inspectors, all of whom require access to the roof areas at various times during the process.

6.5.2.1 Planning

Stockpiling, storage, and conveyance of materials should be addressed during the planning and coordination process. During storage, plants should be protected by screens when possible to prevent overexposure and excessive drying. Growing media can be procured in small sacks that can be moved manually, in large “super sacks” that can be manipulated with a crane, or in bulk and distributed by blowers. When storing materials on the roof, check the structural limitations to prevent overloading the roof.

During construction, it is vitally important that the waterproof membrane be protected once installed. The waterproofing should be tested prior to placement of the growth media and other subsequent vegetated roof materials. Electronic leak detection systems are an optional technology designed to precisely locate a leak if one occurs after construction. Using a leak detection system reduces the likelihood that the significant portions of the vegetated roof materials will have to be removed in the event of a leak. Incorporating this technology should be evaluated for feasibility during the design process. Making the roofing contractor responsible for the vegetated roof installation, either directly or by means of subcontracted services, can help ensure that the integrity of the waterproof membrane is maintained during construction.

The vegetated roof is a combination of an architectural system, an engineered system, and a living landscape; therefore, it is important to address specific site characteristics and goals for the roof in the design of the various subsystems and the selection of components. Site characteristics that influence design include climate, strength of the supporting structure, orientation to sun and shade, slope, size and dimensions, type of waterproofing, public access, roof drainage elements such as drains and scuppers, wind patterns, and fire safety. Typically, green roof design includes multiple objectives or benefits, such as stormwater management, energy efficiency, aesthetics and amenity value, and biodiversity and habitat. Additional design objectives should incorporate fall protection and safety provisions during construction and maintenance,

and easy access for regular maintenance. To address these factors and considerations, a typical vegetated roof is designed by an experienced professional who is knowledgeable about the techniques and materials used in constructing these systems.

During design of a vegetated roof, a number of disciplines will likely be involved. The architect typically establishes dimensions, slopes, and roof drainage patterns to be compatible with the vegetated roof. A mechanical engineer typically designs the roof drainage elements and building plumbing, and locates HVAC equipment and maintenance access zones for rooftop equipment. A structural engineer will be required to analyze the loads on the roof and identify areas where materials can safely be stockpiled and staged during construction. A civil engineer may be involved to analyze the effect of the vegetated roof on site drainage and stormwater control systems. A landscape designer may be extensively involved to create a unique planting palette and design, or less involved if a utilitarian roof is desired. An irrigation designer may also be needed, depending on the planting scheme and the climate.

Key steps in the installation of a vegetated roof are:

- Preparing the roof deck.
- Waterproofing the roof deck.
- Testing the waterproofing.
- Installing a root barrier, protection layer, and edging materials.
- Installing the drainage layer.
- Conveying and spreading the growing medium.
- Installing the plants and erosion control materials.

Two new American National Standard Institute (ANSI) standards are available for vegetated roof design. ANSI/SPRI VF-1 External Fire Design Standard for Vegetative Roofs describes design, methods, materials, and maintenance for external fire resistance. ANSI/SPRI RP-14 Wind Design Standard for Vegetative Roofing Systems describes the wind forces prevalent on roofs and design, methods, materials, and maintenance to prevent scouring of the growth media and other wind damage.

6.5.2.2 Types of vegetated roofs

Green roofs are typically divided into three categories, “extensive” (1.5-6 inches deep), “intensive” (anything deeper than 6 inches), and “semi-intensive” (some combination of intensive and extensive depth ranges). These distinctions are somewhat arbitrary; however, in the past they have indicated the kinds of plants and functions the green roof will provide. Native soils are heavy and poorly drained and would exert unnecessarily heavy loads for an extensive vegetated roof installation, particularly when wet. Extensive roofs typically use light-weight soil mixes to reduce loads. Installations often range from 2-6 inches in depth, and research in Germany indicates that, in general, a 3-inch soil depth offers the best environmental and aesthetic benefit to cost ratio (Miller, 2002), depending on the climate. Data from vegetated roofs installed in Seattle and Vancouver, B.C. show that a 4-inch soil depth is nearly as effective as 6- and 8-inch depths in mitigating runoff from storm events in the Pacific Northwest (BCIT, 2006; Taylor, 2008).

One of the first steps in the design is to establish the allowable weight of the vegetated roof system. For existing buildings, the building structure should be evaluated by a structural engineer to determine the available capacity to bear the additional weight of the vegetated roof. For new buildings, structural design calculations should account for the weight of the proposed roof system.

While vegetated roofs can be installed on slopes up to 40 degrees, slopes between 5 and 20 degrees (1:12 and 5:12) are most suitable and can provide natural drainage by gravity. Roofs with slopes greater than 10 degrees (2:12) require an analysis of engineered slope stability (Green Roofs for Healthy Cities, 2006), and those greater than 20 degrees require a structural reinforcement system and additional assemblies to hold the soil substrate and drainage aggregate in place (Scholtz-Barth, 2001).

6

6.5 Vegetated Roofs

6.5.2 design



figure 6.5.2

Placing growing media in super sacks with a crane and applying media with a blower.
Source: Hadj Design

All vegetated roofs consist of four basic components (see figure 6.5.3):

- Waterproof membrane
- Drainage layer
- Lightweight growth medium
- Vegetation

In addition to these basic components, many systems may also incorporate a protection layer and root barrier to preserve the integrity of the waterproof membrane, a separation/filter layer to stabilize fine particles, capillary mats, and mulch/mats to retain moisture and prevent surface erosion due to rain and wind scour.

There are two types of vegetated roof assemblies: modular and loose laid. Modular assemblies are either containers or pre-vegetated mats. The containers are from 3-6 inches deep and are approximately 3-4 feet wide. Pre-vegetated mats are usually high-density polypropylene filament mesh approximately $\frac{3}{4}$ inch thick that are planted with vegetation whose roots intertwine with the filaments. Loose laid assemblies are mats that have each element independently installed. There are advantages and disadvantages to each approach and modular and loose laid assemblies can be incorporated into one installation.

Finally, there are three common roof deck assemblies that influence green roof design:

- Inverted roof membrane assembly
- Conventional roof membrane assembly
- Cold roof assembly

Each is defined by the relationship among the roof insulation, the roof deck, and the waterproof membrane. In an inverted roof membrane assembly, the insulation is placed above the membrane with the geotextiles, growth media, and plants placed above. In a conventional roof membrane assembly, the membrane is on top of the insulation, which, in turn, rests on the roof deck. A cold roof assembly has the membrane on top of the roof deck and the insulation placed under the deck and separated from the underside of the deck by a ventilation space.

6.5.3 Components

figure 6.5.3

Typical vegetated roof section.
 Source: Graphic courtesy of Environmental Services, Portland, Oregon.

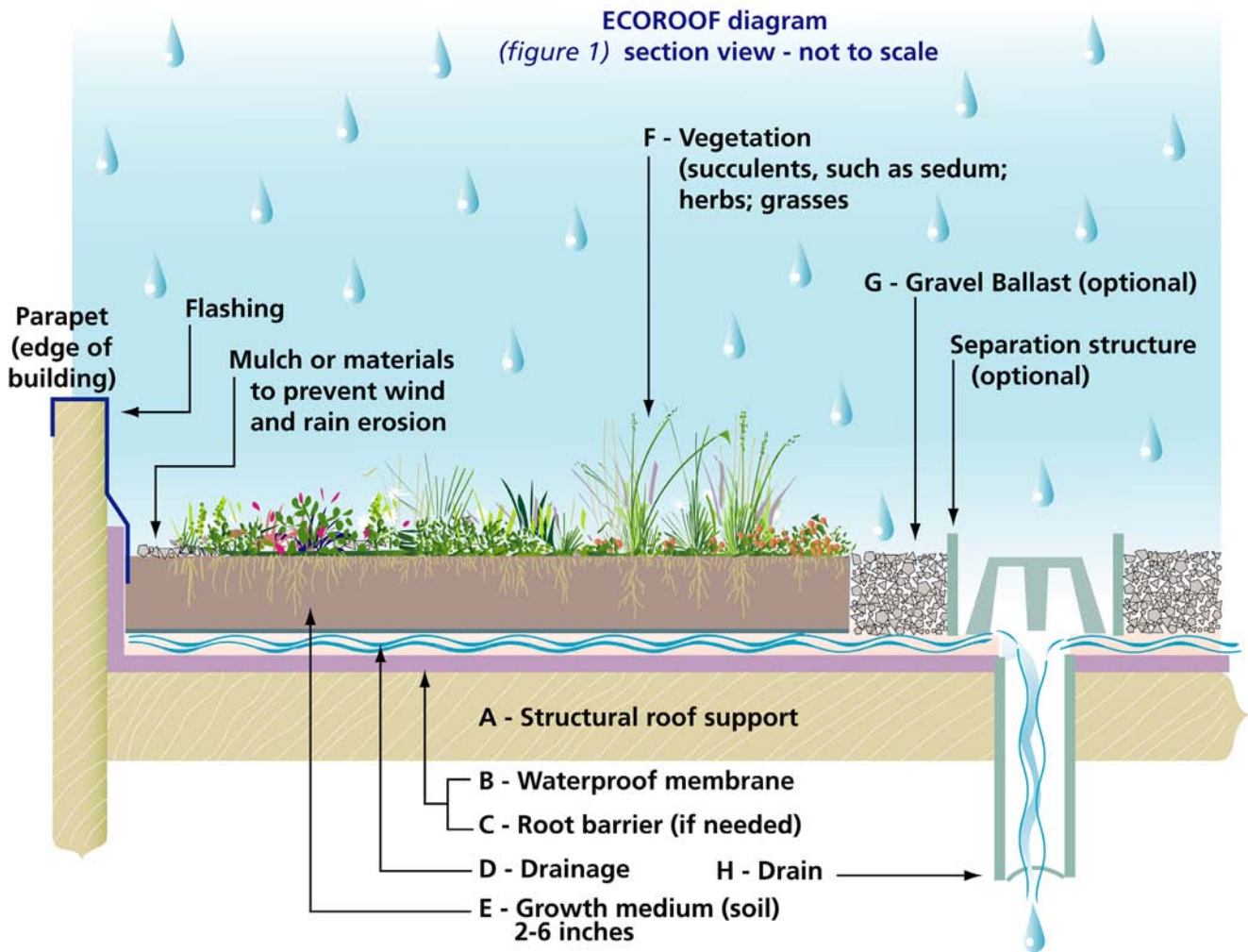

6.5.3.1 Roof deck

The roof deck can be made of steel, concrete, plywood, or any other material sufficiently strong to support the load of the green roof between framing members and provide an acceptable substrate for the membrane. Its drainage planes must be slightly more aggressive than those designed for a typical flat roof because minor ponding will not evaporate as quickly under a green roof assembly. The deck may also be supplemented

by other materials, such as fiber cement board, used to provide a bondable surface for certain membrane types.

6.5.3.2 Waterproof membrane

Waterproof membranes used for vegetated roofs are generally slightly thicker than those used for standalone applications. Built-up roofing is still used in some instances; however, most of the current waterproof membranes fall under the following categories:

6

6.5 Vegetated Roofs

6.5.3 components

- Single-ply membranes such as:
 - » EPDM (Ethylene propylene diene monomer), a rubber that comes in either reinforced or non-reinforced varieties.
 - » TPO (Thermoplastic polyolefin) or PVC (Polyvinyl chloride). Both of these are thermoplastics.
- Multi-ply membrane applications such as:
 - » SBS (styrene butadiene styrene)
 - » APP (Attactic polypropylene)
- Fluid or spray applied membranes of various chemical compositions, such as resins, Urethanes, EPDM, butyl-modified bitumen, among others.

Different manufacturers of the same type of membrane may produce different qualities of product. So all TPO's, for instance, are not identical. Asphaltic membranes contain a carbon that is attractive to plant roots. Most asphaltic membranes, therefore, require a root barrier to be installed if they are used in a green roof assembly. Different membranes may have more recycled content, may be more readily recyclable, have less embodied energy, or have less impact on the environment in general, making them "greener" than the alternatives. In a retrofit scenario, some membranes may be chemically incompatible with materials in the previous application. For example, asphaltic materials are chemically incompatible with materials such as TPO and PVC.

Membranes can be mechanically fastened or adhered to the roof deck; however, it is generally recommended they be fully adhered. In conjunction with the field membrane (the membrane that covers the large areas of the roof), there is also the flashing membrane. Flashing membrane is generally thinner, more flexible, and not reinforced in order for it to fit around various shapes like corners and roof deck penetrations. Like the field membrane, it is waterproof. When leaks occur, the vast majority of them are in areas around flashing. Membrane manufacturers have developed pre-molded flashing elements to reduce chance of leakage in these areas.

Each of the membrane types mentioned has its own process to bond waterproof seams. EPDM use

solvents and adhesives, like a tire patch kit. TPO and PVC use hot air to melt plies into each other. SBS uses open flame torches. Many membrane applications can involve several different types of adhesion or bonding. For example, TPO and PVC can use both hot air and adhesives to bond in different situations. In addition to membrane applications like field membrane and flashing membrane, there is also count-flashing that is not waterproof and is designed to shed water away from vulnerable areas, such as membrane terminations. Details for membrane roofing are readily available from membrane manufacturers and organizations like the Sheet Metal and Air Conditioning Contractors' National Association and the National Roofing Contractors Association. Membrane manufacturers have warranty details that must be used in their assemblies in order to qualify for warranty coverage.

6.5.3.3 Drainage layer

All green roofs should have a drainage component. Usually this takes the form of a drain mat or granular drainage media. Drain mats come in many configurations, from polyethylene dimpled sheets with cups that hold water to polypropylene filament. They rest on the waterproof membrane and in some situations serve as a membrane protection. Granular drainage material is free from organics and usually rests on a protection fabric placed on the membrane.

Drainage elements serve two functions:

1. Remove excess water from saturated growth media (soil mix).
2. Help provide aeration to the bottom layer of growth media.

They are designed to resist the compressive forces of the growth media and vegetation above. Drain mats are also frequently used under non-vegetated areas, such as inert border areas to protect the membrane, as well as to ensure good drainage on the entire roof.

Many drain mats come with an adhered filter fabric. The role of filter fabric is to contain the fines and organics within the planted area. Filter fabric is non-woven polyethylene, polystyrene or other inert material. In time, roots will penetrate the fabric; however, the critical time for its proper functioning is within the first

5-10 years of the roof's soil and plant development. Filter fabric must be placed between the growth media and any other element, horizontal or vertical. If the vegetation is not bounded by a parapet, some other kind of border or soil restraint is placed on top of the drainage and filtration layers and around the perimeter of the planted area. Frequently, this is an aluminum angle to the height of the soil depth. This restraint must be inert and sturdy enough to withstand the overturning forces of the adjacent soil mix. Placing the perimeter restraint on the drain mat/layer allows drainage water to freely flow below it.

6.5.3.4 Growth media

Growth media is considered by many to be the most complex component of green roofs. The growth media must support the chemical, biological, and physical requirements of the plants even though it is designed as a thin layer without the thermal, biological, and hydrologic advantages of soil at grade.

The growth media should never be confused with topsoil. In general, it is composed of porous and lightweight mineral aggregate, such as pumice, lava rock, expanded shale and expanded slate. The gradation of the mineral aggregate particles and the general composition will vary in order to achieve different performance characteristics. The mineral aggregate will be from 70-90 percent of the total mix. Organic content, frequently in the form of bio-stable compost, makes up the bulk of the remaining material. Other elements such as root stimulators, shock reducers, soil biota, bacterial washes, and soil shear enhancers are sometimes used as well.

Excessive organic content should be avoided. Target levels are based on experience with vegetated roofs that indicates the amount of organic material that will be stable and result in a system that achieves a balance between annual growth and dieback. The volatile organic content is typically less than 10 percent. Greater organic content can lead to system instability over time as the materials decompose and the depth of the growth media is correspondingly diminished.

Saturated loads of 15-50 pounds/square foot are typical for extensive roofs with 2-6-inch soil depths (Scholtz-Barth, 2001). Vegetated roofs weighing 15 pounds/



figure 6.5.4

The Portland, OR roof (top) is planted with a mix of sedums and grasses. The Seattle, WA roof (below) has a varying soil depth to accommodate grasses, herbs and trees.

Source: Curtis Hinman

6

6.5 Vegetated Roofs

6.5.4 maintenance

square foot (comparable to typical gravel ballast roofs) have been installed and are currently functioning in the U.S. At 15-50 pounds, many roofs can be retrofitted with no or minimal reinforcement, depending on the type of roof and the building structure (MKA, 2007). Separating the growth medium from the building perimeter and roof penetrations with a non-combustible material (e.g., gravel) can provide increased protection against the spread of fire, easier access to flashing and membrane connections, and additional protection from root penetration (Peck et al., n.d.).

F.L.L. has a comprehensive standard specification for three growth media; however, these specifications while useful should be reviewed carefully because North America has a wider distribution of climates and plant ecologies than Germany. In specifying growth media, ASTM E2396 through E2400 are referred to for evaluating various growth media and granular drainage characteristics.

6.5.3.5 Vegetation

The plants on vegetated roofs are typically succulents, grass, herbs, and/or wildflowers adapted to the harsh conditions (minimal soils, seasonal drought, high winds, and strong sun exposure—i.e., alpine conditions) prevalent on rooftops. Plants should have a proven capacity to tolerate rooftop growing conditions, such as extreme temperatures and drought. Some examples of plant species are sempervivum, sedum, creeping thyme, allium, phloxes, and anttenaria. (Scholtz-Barth, 2001).

Green roofs are not native environments. As a result, many native plants that do well at grade do very poorly on adjacent green roofs. Two identical green roofs very close to one another may develop differently due to subtle differences in their microclimates. The designer should identify the different zones of exposure and moisture on the roof prior to developing the planting scheme. Rooftops have many microclimates to consider. Vertical surfaces, such as walls and parapets, may shade or reflect light and heat onto plantings depending on their orientation. The parts of the roof near the top of a slope are frequently drier and

more prone to drought conditions than the areas at the toe of a slope and around roof drains, where moisture tends to collect.

As growth media becomes deeper, a wider variety of plants can be used. At 2-3 inches mosses, sedums, and some grasses are possible. At 3-5 inches a wider array of sedums and grasses are possible, with the addition of some herbaceous perennials. And at 6-8 inches a relatively wide variety of the genera is possible. The varieties of plants can start to approximate the plants at grade when the growth media is deeper than 8 inches.

Plants can be installed as vegetated mats, individual plugs, spread as cuttings, or by seeding. Vegetated mats and plugs provide the most rapid establishment for sedums. Cuttings spread over the substrate are slower to establish and will likely have a high mortality rate; however, this is a good method for increasing plant coverage on a roof that is in the process of establishing a plant community (Scholtz-Barth, 2001). During the plant establishment period, soil erosion can be reduced by using a biodegradable mesh blanket or a hydro-mulch paper emulsion.

6.5.4 Maintenance

Proper maintenance and operation are essential to ensure the designed performance and benefits continue over the full life cycle of the installation. Each vegetated roof installation will have specific design, operation, and maintenance guidelines provided by the manufacturer and installer.

The following guidelines provide a general set of standards for prolonged vegetated roof performance. Note that some maintenance recommendations are different for extensive versus intensive vegetated roof systems. The procedures outlined below focus on extensive roof systems, and different procedures for intensive roofs are noted.

Schedule

- All facility components, including structural components, waterproofing, drainage layers, soil substrate, vegetation, and drains, should be inspected for proper operation throughout the life of the system.
- The manufacturer or designer should provide the maintenance and operation plan and inspection schedule.
- All elements should be inspected no less than two times per year for extensive installations and four times annually for intensive installations. Some manufacturers suggest monthly inspections.
- The facility owner or maintenance contractor should keep a maintenance log, recording inspection dates, observations, and activities.
- Inspections should be scheduled to coincide with maintenance operations and with important horticultural cycles (e.g., before major weed varieties disperse seeds).

Structural and drainage components

- Structural and drainage components should be maintained according to manufacturer's requirements and accepted engineering practices.
- Drain inlets should provide unrestricted stormwater flow from the drainage layer to the roof drain system unless the assembly is specifically designed to impound water as part of an irrigation or stormwater management program.
 - » Clear the inlet pipe of soil substrate, vegetation, or other debris that may obstruct free drainage of the pipe. Sources of sediment or debris should be identified and corrected.
 - » Inspect the drain pipe inlet for cracks, settling, and proper alignment, and correct and re-compact soils or fill material surrounding the pipe if necessary.
- If part of the roof design, inspect fire ventilation points for proper operation.

Vegetation management

- The vegetation management program should establish and maintain a minimum of 90 percent plant coverage on the soil substrate.
- During regularly scheduled inspections and maintenance, bare areas should be filled in with manufacturer-recommended plant species to maintain the required plant coverage.
- Normally, dead plant material will be recycled on the roof; however, specific plants or aesthetic considerations may warrant removing and replacing dead material (see manufacturer's recommendations).
- Invasive or nuisance plants should be removed regularly and not allowed to accumulate and exclude planted species. At a minimum, schedule weeding with inspections to coincide with important horticultural cycles (e.g. before weed varieties disperse seeds).
- Weeding should be performed manually and without herbicide applications when possible.
- Extensive roof gardens should be designed to require minimal fertilization after plant establishment. If fertilization is necessary during plant establishment or for plant health and survivability after establishment, use an encapsulated, organic slow release fertilizer (excessive fertilization can contribute to increased nutrient loads in the stormwater system and receiving waters). If possible, test the growth medium prior to fertilization. Some membranes are resistant to fertilizers and others are not; check with the membrane manufacturer prior to fertilizer application.
- Intensive vegetated roofs typically require more fertilization than extensive roofs. Follow manufacturer's and installer's recommendations.
- Avoid application of mulch on extensive roofs. Mulch should be used only during plant establishment or in unusual situations, and according to the roof manufacturer's guidelines. In conventional landscaping, mulch enhances moisture retention; however, moisture on a vegetated roof should be controlled by means of proper growth media design. Mulch can also increase the establishment of weeds.

6

6.5 Vegetated Roofs

6.5.5 performance

Irrigation

- Plant selection directly affects water requirements for the vegetated roof.
- Surface irrigation systems on extensive roof gardens can promote weed establishment and root development near the drier surface layer of the soil substrate, and increase plant dependence on irrigation. Accordingly, subsurface irrigation methods are preferred. If surface irrigation is the only method available, use drip irrigation to deliver water to the base of the plant.
- Extensive roofs should be watered only when absolutely necessary for plant survival. When watering is necessary (i.e., during early plant establishment and drought periods), saturate to the base of the soil substrate (typically 30-50 gallons per 100 square feet) and allow soil to dry completely.

Operation and maintenance agreements

- Written guidance and/or training for operating and maintaining the vegetated roof should be provided along with the operation and maintenance agreement to all property owners and tenants.

Contaminants

- Measures should be taken to prevent the possible release of pollutants to the roof garden from mechanical systems or maintenance activities on mechanical systems.
- Any cause of pollutant release should be corrected as soon as identified and the pollutant removed. Contact the membrane manufacturer regarding potential damage to the membrane due to contaminants.

Insects

- Properly designed vegetated roofs will provide drainage rates that do not allow pooling of water for periods that are long enough to promote development of insect larvae. If standing water is present for extended periods, inspect the drainage elements and correct the drainage problem.
- Chemical sprays should not be used.

Access and safety

- Egress and ingress routes should be clear of obstructions and maintained to design standards (City of Portland, 2002; personal communication, Charlie Miller, February 2004).
- Safety procedures appropriate for maintaining the roof should be clearly identified and should include training of workers, fall prevention systems, and safety harnesses.

6.5.5 Performance

Vegetated roof designs require careful attention to the interaction between the different components of the system. Saturated hydraulic conductivity, porosity and moisture retention of the growth media, and transmissivity of the drainage layer strongly influence hydrologic performance and reliability of the design (Miller and Pyke, 1999).

Research in Europe, in climates similar to the northeastern U.S., has consistently indicated that roof gardens can reduce up to 50 percent of the annual rooftop stormwater runoff (Miller and Pyke, 1999). During a 9-month pilot test in eastern Pennsylvania, 14 and 28-square foot trays with test vegetated roof sections received a total of 44 inches of precipitation and generated 15.5 inches of runoff (runoff was negligible for storm events producing less than 0.6 inch of rainfall). The pilot section was 2.74 inches thick, including the drainage layer (USEPA, 2000b).

In Portland Oregon, a 4- to 4.5-inch eco-roof retained 69 percent of the total rainfall during a 15-month monitoring period. In the first January-to-March period (2002), rainfall retention was 20 percent and during January-to-March (2003) retention increased to 59 percent. The most important factors likely influencing the different retention rates are vegetation and substrate maturity, and rainfall distribution. The 2002 period was a more even rainfall distribution and the 2003 period more varied with longer dry periods between storms (Hutchison, Abrams, Retzlaff and Liptan, 2003). This supports observations by other researchers that vegetated roofs are likely more effective for controlling brief (including relatively intense) events compared to long-duration storms (Miller, 2002).

6.6 Minimal Excavation Foundation Systems

Excavation and movement of heavy equipment during construction compacts and degrades the infiltration and storage capacity of soils.

“Minimal excavation foundation systems limit soil disturbance and allow storm flows to more closely approximate natural shallow subsurface interflow paths.”

When properly dispersed into the soils adjacent to and in some cases under the foundation, roof runoff that would otherwise be directed to bioretention areas or other LID facilities can be significantly reduced.

Minimal excavation foundation systems take many forms, but in essence are a combination of driven piles and a connecting component at, or above, grade. The piles allow the foundation system to reach or engage deeper load-bearing soils without having to dig out and disrupt upper soil layers, which convey, infiltrate, store, and filter stormwater flows. These piles are a more “surgical” approach to earth engineering, and may be vertical, screw-augured, or angled pairs that can be made of corrosion protected steel, wood, or concrete. The connection component handles the transfer of loads from the above structure to the piles and is most often made of concrete. Cement connection components may be pre-cast or poured on site in continuous perimeter wall or isolated pier configurations. For a given configuration, appropriate engineering (analyzing gravity, wind, and earthquake loads) is applied for the intended structure. Several jurisdictions in the Puget Sound region have permitted minimal excavation foundations for the support of surface structures, including Pierce, King, and Snohomish counties and the cities of Olympia, Tacoma, and Bellingham.

6.6.1 Applications

Minimal excavation foundations in both pier and perimeter wall configurations are suitable for residential or commercial structures up to three stories high (See figures 6.6.1, 6.6.2 and 6.6.3). Secondary structures such as decks, porches, and walkways can also be supported, and the technology is particularly useful for elevated paths and foot-bridges in open spaces and other environmentally sensitive areas. Wall configurations are typically used on flat to sloping sites up to 10 percent, and pier configurations flat to 30 percent. Some applications may be “custom” or “one-off” designs where a local engineer is employed to design a combination of conventional piling and concrete components for a specific application. Other applications may employ pre-engineered, manufactured systems that are provided by companies specifically producing low-impact foundation systems for various markets.

figure 6.6.1

Pin foundation application for grade beam construction.
Source: Graphic courtesy of PIN Foundations Inc.

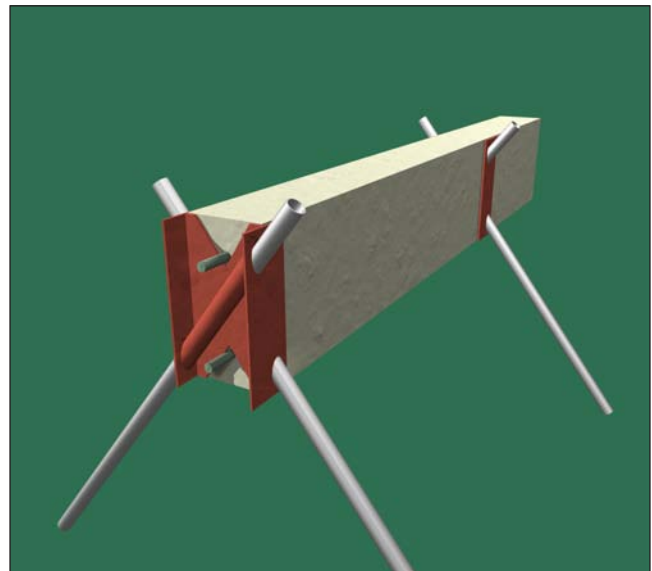

6 6.6 Minimal Excavation Foundations

6.6.2 design

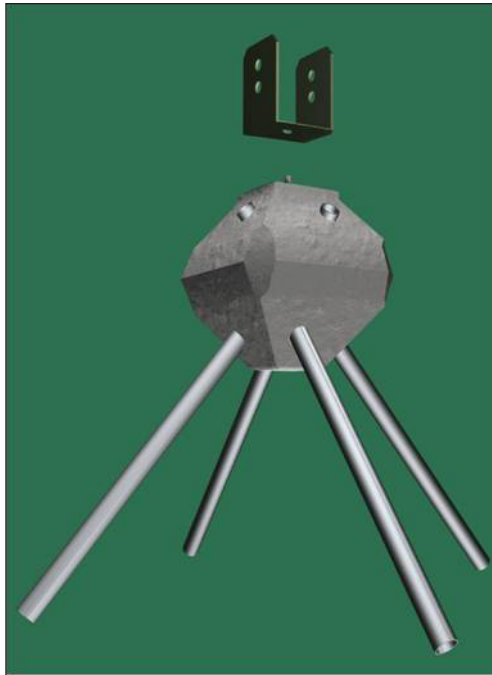

figure 6.6.2

Pin foundation application for pier construction.
Source: Graphic courtesy of PIN Foundations Inc.



figure 6.6.3

This small commercial building in Olympia, WA is constructed on a minimal excavation pin foundation. The project also includes pervious concrete and bioretention.
Source: Photo by Tom Holz.

The minimal excavation foundation approach can be installed on A/B and C/D soils (USDA Soil Classification), provided the material is penetrable and will support the intended type of piles. Typical soils in the Puget Sound region, including silt loams, sandy loams, fine gravels, tight soils with clay content, and partially cemented tills are applicable. Soils typically considered problematic due to high organic content (top soils or peats) or overall bearing characteristics may often remain in place provided their depth is limited and the pins have adequate bearing in suitable underlying soils. These systems may be used on fill soils if the depth of the fill does not exceed the reaction range of the intended piles. Fill compaction requirements for support of such foundations may be below those of conventional development practice in some applications. In all cases, for both custom and pre-engineered systems, a qualified engineer should determine the appropriate pile and connection components and define criteria for specific soil conditions and construction requirements.

6.6.2 Design

Based on the type of structure to be supported and the specific site or lot topography, a pier type foundation or perimeter wall type foundation must first be selected.

6.6.2.1 Pier Applications

Piers using pin piles can be used for various structure types, including residential and light commercial buildings. When designing with piers, the engineer or vendor supplies the structural requirements (pile length and diameter and pier size) for the pier system. The architect then determines the number and location of piers given the structure size, loads, and load bearing location (see figure 6.6.4).

Grading for piers

Pier applications require grubbing, and in some cases, blading to prepare the site. The permeability of some soil types can be significantly reduced even with minimal equipment activity; accordingly, the lightest possible tracked equipment should be used for preparing or grading the site. Consult a licensed engineer with soils experience for specific recommendations.



figure 6.6.4

Pin pier foundation and finished house on Bainbridge Island, WA.

Source: Photo courtesy of Rick Gagliano.

On relatively flat sites, blading should be limited to shaping the site for the best possible drainage and infiltration. Removing the organic topsoil layer is not typically necessary. On sloped sites, the soils may be bladed smooth at their existing grade to receive pier systems, again with the goal of achieving the best possible drainage and infiltration. This will result in the least disturbance to the upper permeable soil layers on sloped sites.

6.6.2.2 Wall applications

Piling combined with pre-cast walls with sloped bases, or slope cut forms for pouring continuous walls, may be used on sites with only minimal topography changes similar to the pier applications. Rectilinear wall systems (flat bottom sections), combined with piles, may also be used, but require more site preparation and soil disturbance.

Grading for flat-bottomed walls

While creating more soil disturbance, sloped sites should be terraced to receive conventional flat-bottomed forms or pre-cast walls. The height difference between terraces will be a result of the slope percentage and the width of the terrace itself. The least impacts to soil will be achieved by limiting the width of each terrace to the width of the equipment blade and cutting as many terraces as possible. Some footprint designs will be more conducive to limiting these cuts and should be considered by the architect. The terracing technique removes more of the upper permeable soil layer and this loss should be figured into any analysis of storm flows through the site. See Chapter 7 for details on flow control analysis of minimal excavation foundations. As with the pier systems, consult a licensed engineer with soils experience for specific recommendations.



figure 6.6.5

Buffer material and pin pile guide placed before concrete perimeter wall pour.

Source: Pin Foundations, Inc.

6

6.6 Minimal Excavation Foundations

6.6.3 construction

With wall systems a free draining, compressible buffer material (pea gravel, corrugated vinyl or foam product) should be placed on surface soils to prepare the site for placement of wall components (see figure 6.6.5). This buffer material separates the base of the grade beam from surface of the soil to prevent impacts from expansion or frost heave, and in some cases is employed to allow movement of saturated flows under the wall.

Additional soil may remain from foundation construction depending on grading strategy and site conditions. The material may be used to backfill the perimeter of the structure if the impacts of the additional material and equipment used to place the backfill are considered when evaluating runoff conditions.

6.6.2.3 Dispersing roof stormwater with minimal excavation foundations

Roof runoff and surrounding storm flows may be allowed to infiltrate without using constructed conveyance when selection of the foundation type and grading strategy results in the top layers of soil being retained and without significant loss to soil permeability and storage characteristics.

Where possible, roof runoff should be infiltrated uphill of the structure and across the broadest possible area. Infiltrating upslope more closely mimics natural (pre-construction) conditions by directing subsurface flows through minimally impacted soils surrounding, and in some cases, under the structure (see figure 6.6.6). This provides infiltration and subsurface storage area that would otherwise be lost in the construction and placement of a conventional “dug-in” foundation system. Passive gravity systems for dispersing roof runoff are preferred; however, active systems can be used if back-up power sources are incorporated and a consistent and manageable maintenance program is ensured. See Section 7.6 for details on flow control analysis of minimal excavation foundations.

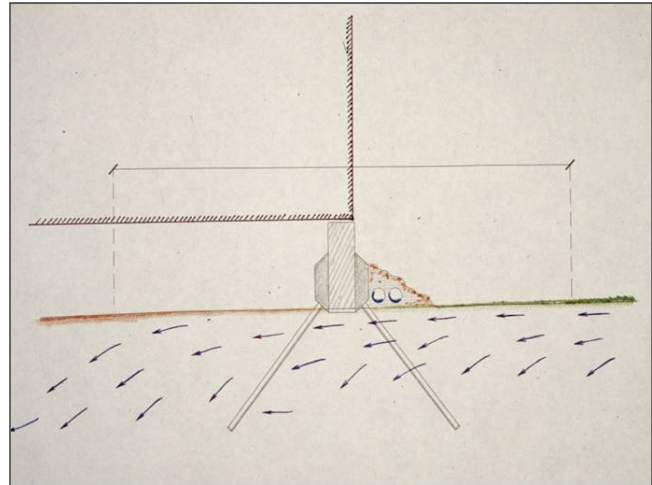

figure 6.6.6

For maximum stormwater management benefit, roof water should be dispersed up-gradient of the structure.

Source: Pin Foundations, Inc.

Garage slabs, monolithic poured patios, or driveways can block dispersed flows from the minimal excavation foundation perimeter and dispersing roof runoff uphill of these areas is not recommended (or must be handled with other stormwater management practices). Some soils and site conditions may not warrant intentionally directing subsurface flows directly beneath the structure, and in these cases, only the preserved soils surrounding the structure and across the site may be relied on to mimic natural flow pathways.

6.6.3 Construction

Minimal excavation systems may be installed “pile first” or “post pile.” The pile first approach involves driving or installing all required piles in specified locations to support the structure, and then installing a connecting component (such as a formed and poured concrete grade beam) to engage the piles. Post pile

**figure 6.6.7**

The grade beam and pile guides are placed first and then pins are driven in this post-pile application.

Source: Photo courtesy of Rick Gagliano.

methods require the setting of pre-cast or site poured components first, through which the piles are then driven. Pile first methods are typically used for deep or problematic soils where final pile depth and embedded obstructions are unpredictable. Post pile methods are typically shallower—using shorter, smaller diameter piles—and used where the soils and bearing capacities are well-defined. In either case, the piles are placed at specified intervals correlated with their capacity in the soil, the size and location of the loads to be supported, and the carrying capacity of the connection component.

Soil conditions are determined by a limited geotechnical analysis identifying soil type, water content at saturation, strength and density characteristics, and in-place weight. However, depending on the pile system type, the size or scale of the supported structure, and the nature of the site and soils, a more complete soils report including slope stability and liquifaction analysis may be required.

The piles are driven with a machine mounted, frame mounted, or hand-held automatic hammer (see figure 6.6.8). The choice of driving equipment should be considered based on the size of pile and intended driving depth, the potential for equipment site impacts,

**figure 6.6.8**

Driving pins with machine mounted and hand-held hammers.

Photos courtesy of Rick Gagliano.

and the limits of movement around the structure. Corrosion rates for buried galvanized or coated steel piling, or degradation rates for buried concrete piling, are typically very low to non-existent, and piling for these types of foundations are usually considered to last the life of the structure. Special conditions such as exposure to salt air or highly caustic soils in unique built environments, such as industrial zones, should be considered. Wood piling typically has a more limited lifetime. Some foundation systems also allow for the removal and replacement of pilings, which can extend the life of the support indefinitely.

6.6.4 Performance

From 2000 to 2001, subsurface flows under a minimal excavation foundation system and crawl space moisture were monitored on the Gig Harbor Peninsula. The study site was a two-story, 2300-square foot single-family residence located on a slightly sloped south facing lot with grass surrounding the house and second growth forest on the perimeter. Preparation for the foundation installation involved applying a thin layer of pea gravel directly on the existing lawn to separate the grade beam from the soil, pouring the grade beam from a pump truck, and driving steel pin piling with a hand held pneumatic hammer. The surface organic material was not removed from the construction area. Roof drains fed perforated weep hoses buried 2-3 inches in shallow perimeter landscape beds upslope of the house to infiltrate roof runoff and direct it along its pre-existing subsurface path under the structure (see figure 6.6.6).

6

6.6 Minimal Excavation Foundations

6.6.4 performance

Soil pits were excavated around and within the foundation perimeter, and gravimetric sampling was conducted to measure soil moisture content on a transect from high slope to low slope within the foundation perimeter. Relative humidity in the crawl space below the house was assessed by comparing the minimal excavation foundation system with two conventional foundation crawl spaces in the same area. The soil analysis found 2-6 inches of existing topsoil overlying a medium dense to very dense silty, fine to coarse sand with small amounts of rounded gravel. Bulk density analysis of the upper 6 inches of the soil profile found no indication of compaction after construction (0.89 to 1.46g/cc or below average to average) and the original lawn vegetation had degraded to a fine brown loam under the plastic vapor barrier in the crawl space. Soil moisture readings indicated that roof runoff was infiltrating into the soils under the house and moving downslope through the subsurface soils. At no time did water pond above the surface, either outside or under the house.

The humidity readings in the crawl space under the minimal excavation foundation system were slightly drier than the conventional crawl space comparison, but statistically equivalent, given the variance of the monitoring equipment (Palazzi, 2002).

Additional structures installed on similar systems over the last few years, though not monitored for subsurface flows, have shown similar reductions in soil compaction impacts to the site and foundation perimeter soils (personal comm. Rick Gagliano).

6.7 Roof Rainwater Collection Systems

Collecting or harvesting rainwater from rooftops has been used for centuries to satisfy household, agricultural, and landscape water needs. Many systems are operating in the Puget Sound region in a variety of settings. On Marrowstone and San Juan islands, where overuse, saltwater intrusion or natural conditions limit groundwater availability, individual homes use rainwater collection for landscaping and potable supplies. In Seattle, the King Street Center building harvests approximately 1.2 million gallons of rainwater annually to supply 60 to 80 percent of the water required for flushing the building's toilets (CH2M HILL, 2001).

Evolution of rainwater

harvesting policy in western Washington

Many of the existing and permitted systems in western Washington operate under a blanket exemption where potable water may not be accessible (e.g., residential development on islands) or as a tool to reduce combined sewer overflows (CSOs) (e.g., in the City of Seattle). One of the largest barriers to broader application of rainwater collection systems has been state permitting. Until recently a water right permit was required for any rainwater collection system; however, monitoring and enforcing compliance for potentially thousands of systems is impractical. With no clear guidance for rainwater collection within the context of the water right process, the region had operated under a policy of allowing de minimus (small or negligible) use whereby small-scale collection of rainwater was ignored.

In late 2009, Ecology issued an Interpretive Policy Statement clarifying that a water right permit is not required for onsite storage and use of rooftop derived rainwater. There is no volume or use limitation (the size of the roof acts as a limiting factor). Ecology reserves the right to regulate the storage and use of new rainwater collection systems (those systems not up and running prior to the regulation) where the cumulative impact of new systems may negatively impact instream values or existing water rights (Ecology, 2009).

6.7.1 Applications

Typically, rainwater collection is used where rainfall or other environmental conditions limit the availability of domestic water supply. Rainwater collection systems can provide multiple benefits, some of which include:

- Reducing summer peak demand.
- Maintaining summer instream flows by reducing residential and commercial surface and ground water withdrawals.
- Reducing costly water distribution infrastructure by collecting water close to the end use.
- CSO reduction in urban areas.
- Providing a sustainable source of potable water where groundwater and surface water is degraded.
- Emergency backup water source if main supply is not available.
- Reducing runoff in urban retrofits or redevelopment where space is limited and other LID IMPs are infeasible.

6.7.1.1 Rainwater harvesting in the stormwater management context

Depending on the physical setting and regulatory requirements, rainwater harvesting systems can be used to meet various flow control goals.

New suburban development

In medium to high-density development with detached single family homes, the roof is likely to be equal to or greater than the road, driveway, and sidewalk impervious surface contribution. If the soils in this setting have very low permeability, the primary LID objective of approximating pre-development (forested or prairie) hydrology is likely not feasible without reducing or eliminating the stormwater contribution from rooftops through rainwater harvesting and indoor use of that water or other applications (see Section 6.7.4: Performance for design examples).

6

6.7 Roof Rainwater Collection Systems

6.7.2 design

Urban CSO reduction

Large capital improvement projects to reduce CSO events are often extremely expensive. In the dense urban setting, rainwater harvesting can provide an additional tool to reduce stormwater volume and/or detain storm flows at the source. For detention, rainwater cistern outlets can be fitted with an orifice to reduce peak flows and the outlet directed to an additional infiltration facility or to the storm sewer. During the growing season months, the cistern outlet can be closed and collected water used for irrigation.

Regardless of the physical setting and stormwater management goals, rainwater collection should not impair freshwater beneficial uses, but rather be used to reduce increased flow volumes, peak volumes, and associated pollutant loads from developed areas that degrade stream, wetlands or marine waters. For heavily developed watersheds where a significant contribution to stream or wetlands is from stormwater outfalls and rainwater collection is implemented for a significant percentage of the roof area, a water balance analysis should be conducted by the local government to assess potential effects on channel habitat and wetland hydroperiods.

Roof rainwater harvesting systems can be used in residential, commercial, institutional or industrial development for new or retrofit projects. The technology for rainwater harvesting is well developed and components readily available; however, system design and construction can be relatively complex and should be provided by a qualified engineer or experienced designer.

Rain barrels are a type of rainwater collection typically used for small storage volumes and garden irrigation, and provide a valuable educational tool to engage the public in water conservation. However, larger storage volumes ranging from 200 gallons (beneficial in CSO reduction) to 5,000-10,000 gallons (typical for supporting partial- or whole-house indoor use) are required to provide adequate storage for the stormwater volume and peak flow reduction necessary to meet stormwater management goals discussed in this section.



figure 6.7.1

Buried cisterns for storing collected rainwater for indoor use on Capitol Hill, Seattle.

Source: Photo courtesy of Tim Pope.

6.7.2 Design

Rainwater collection systems should be sized according to precipitation inputs, indoor and/or outdoor water needs, and the flow reduction required to approximate pre-development hydrology. Rainwater harvesting should work in concert with other LID practices and therefore reduce the roof contribution, downstream LID flow control practices, and overall costs of the stormwater management system. The following design guidelines focus on indoor water use. For rainwater harvesting systems designed for peak flow and CSO control, which require fewer design components, see Seattle RainWise Program online at Seattle Public Utilities.

In the Pacific Northwest the highest precipitation (supply) and lowest demand months are November to May. June through October is relatively dry and demand, driven primarily by landscape needs, is greatest during this period. To collect and remove adequate storm flows during the higher precipitation months and provide a reliable water source, large storage reservoirs or cisterns are required. In the Maritime Northwest rainwater collection should be

sized to store as much rainfall as possible in April and May to provide water as far into the summer months as possible. Where stormwater is a primary incentive for installation and municipal or groundwater supplies are available, the rainwater collection system can be installed with, and augmented by, a conventional water source.

In 2009, The State Building Code Council adopted the 2009 edition of the Uniform Plumbing Code. Significant changes were made to Chapter 16, which governs the use of reclaimed water. Previous plumbing code did not distinguish reclaimed water from rainwater. The new adopted code has a separate set of regulations that governs some aspects of rainwater harvesting (for indoor use only). Where applicable, such code will be referenced below. This code went into effect July 1, 2010 and is codified in WAC 51-56-1600. Rainwater harvesting systems should only collect water from roof surfaces and not from vehicle or pedestrian areas, surface water runoff or bodies of standing water (WAC 51-56-1400, Section 1627.1).

6.7.2.1 Components of a rainwater collection system

Specific components and configurations used in a rainwater harvesting system will depend on the rainfall pattern, physical setting, water needs, and stormwater management goals.

Catchment or roof area

The roof material should not contribute contaminants (such as zinc, copper or lead) to the collection system (WAC 51-56-1628.1). The National Sanitation Foundation (NSF) certifies products for rainwater collection systems. Products meeting NSF protocol P151 are certified for drinking water system use and do not contribute contaminants at levels greater than specified in the USEPA Drinking Water Regulations and Health Advisories (Stuart, 2001). Rainfall present in the Pacific Northwest is surprisingly acidic and will tend to leach materials from roofing material.

General guidelines for calculating rooftop area and water production for a rainwater collection system:

- The catchment area is equal to the length times width of the guttered area (slope is not

considered).

- One inch of rain falling on one square foot of rooftop will produce 0.6233 gallons of water or approximately 600 gallons per 1,000 square feet of roof without inefficiencies.
- Assume that the system will lose 10-25 percent of the total rainfall due to evaporation, initial wetting of the collection material, and inefficiencies in the collection process (Texas Water Development Board, 2005). Precipitation loss is the least with metal, more with composition, and greatest with wood shake or shingle.

Roof materials

Currently, few roof materials have been tested and the only recommendation for common roof coverings is to not use treated wood shingles or shakes.

- Enameled standing seam metal, ceramic tile or slate are durable and smooth, presumed to not contribute significant contaminants, and are the preferred materials for potable supply.
- Composition or 3-tab roofing should only be used for irrigation catchment systems. Composition roofing is not recommended for irrigation supply if zinc has been applied for moss treatment.
- Lead solder should not be used for roof or gutter construction and existing roofs should be examined for lead content.
- Galvanized surfaces may deliver elevated particulate zinc during initial flushing and elevated dissolved zinc throughout a storm event (Stuart, 2001).
- Copper should never be considered for roofing or gutters. When used for roofing material, copper can act as an herbicide if rooftop runoff is used for irrigation. Copper can also be present in toxic amounts if used for a potable source.

Gutters and downspouts

Gutters are commonly made from aluminum, galvanized steel, and plastic. Rainwater is slightly acidic; accordingly, collected water entering the cistern should be evaluated for metals or other contaminants associated with the roof and gutters. See below for appropriate filters and disinfection techniques. Do not

6

6.7 Roof Rainwater Collection Systems

6.7.2 design

use lead solder for gutter seams. WAC 51-56-1628.2 states that copper or zinc gutters and downspouts shall not be used; however, if existing gutters and downspouts are already in place, the interior shall be coated with an NSF-quality epoxy paint.

Screens should be installed in the top of each downspout. Screens installed on gutters prevent coarse (e.g., leaves and needles), but not fine debris (pollen and dust) from entering the gutter. Gutters will still require cleaning and access should be considered when selecting gutter screens.

First flush diverters

First flush diverters collect and route the first flush away from the collection system. The initial flow from a storm can contain higher levels of contaminants from particulates settling on the roof (e.g., bird droppings). A simple diverter consists of a downspout (located upstream of the downspout to the cistern) and a pipe that is fitted and sealed so that water does not back flow into the gutter. Once the pipe is filled, water flows to the cistern downspout. The pipe often extends to the ground and has a clean out and valve.

The Texas Rainwater Guide recommends that the first 10 gallons of water be diverted for every 1000 square feet of roof (applicable for areas with higher storm intensities) (Texas Water Development Board, 2005). However, local factors such as rainfall frequency, intensity, and pollutants will influence the amount of water diverted. In areas with low precipitation and lower storm intensities, such as the San Juan Islands, roof washing may divert flows necessary to support system demands. Additionally, the gentle rainfall prevalent in western Washington may not be adequate to wash contaminants from the roof in the first flush. In this scenario, pre-filtration (e.g., roof washers) for coarse material placed before the storage reservoir and fine filtration (e.g., 5 microns) placed before disinfection is likely more effective (personal communication Tim Pope, August 2004).

Roof washers

Roof washers are placed just before the storage cistern to filter coarse and fine debris. Washers consist of a tank (typically 30-50 gallons), a coarse filter/strainer for leaves and other organic material, and a finer filter (typically 30-microns or less). Roof washers should be cleaned regularly to prevent clogging as well as prevent the development of pathogens (Texas Water Development Board, 2005).

WAC 51-56-1628.3 governs roof washers. The following provisions apply:

- All rainwater harvesting systems using impervious roof surfaces shall have at least one roof washer per downspout or pre-filtration system. A roof washer or pre-filtration system is not required for pervious roof surfaces such as green roofs. Roof washers and pre-filtration systems shall meet the following design requirements:
 1. All collected rainwater shall pass through a roof washer or pre-filtration system before the water enters the cistern(s).
 2. If more than one cistern is used, a roof washer or pre-filtration system shall be provided for each cistern. EXCEPTION: Where a series of cisterns are interconnected to supply water to a single system.
 3. The inlet to the roof washer shall be provided with a debris screen that protects the roof washer from the intrusion of waste and vermin.
 4. The roof washer shall rely on manually operated valves or other devices to do the diversion.
 5. Roof washers shall be readily accessible for regular maintenance.
 6. Pre-filtration screens or filters shall be maintained consistent with manufacturer's specifications.

Storage tank or cistern

The cistern is the most expensive component of the collection system. Cisterns are commonly constructed of fiberglass, polyethylene, concrete, metal, or wood. Larger tanks for potable use are available in either fiberglass for burial or corrugated, galvanized steel with PVC or Poly liners for above ground installations. Tanks can be installed above ground (either adjacent to or remote from a structure), under a deck, or in the basement or crawl space (see figure 6.7.2 for examples). Above ground installations are less expensive than below ground applications. Aesthetic preferences or space limitations may require that the tank be located below ground, or away from the structure. Additional labor expenditures for excavation and structural requirements for the tank will increase costs of subsurface installations compared to above ground storage (Stuart, 2001). Multiple tank systems are generally less expensive than single tanks and the multi-reservoir configurations can continue to operate if one of the tanks needs to be shut down for maintenance (see figure 6.7.2 for cistern examples).



figure 6.7.2

Examples of steel, cement, plastic, and wall mounted cisterns.

Source: Curtis Hinman, Tim Pope & Michael Broili



6

6.7 Roof Rainwater Collection Systems

6.7.2 design

WAC 51-56-1628.4 governs cisterns. The following provisions apply:

1. All cisterns shall be listed for use with potable water and shall be capable of being filled from both the rainwater harvesting system and the public or private water system (WAC 51-56-1628.4).
2. The municipal or on-site well water system shall be protected from cross-contamination in accordance with Section 603.4.5 of the Uniform Plumbing Code.
3. Backflow assemblies shall be maintained and tested in accordance with Section 603.3.3.
4. Cisterns shall have access to allow inspection and cleaning.
5. For above grade cisterns, the ratio of the cistern size shall not be greater than 1:1 height to width. An engineered tank with an engineered foundation may have a height that exceeds the width (subject to approval of the authority having jurisdiction). The ratio for below grade cisterns is not limited.
6. Cisterns may be installed either above or below grade. All cisterns shall be installed in accordance with the manufacturer's installation instructions. Where the installation requires a foundation, the foundation shall be flat and be capable of supporting the cistern weight when the cistern is full.
7. Below grade cisterns shall be provided with manhole risers a minimum of 8 inches above surrounding grade. Underground cisterns shall have tie downs per manufacturer's specifications, or the excavated site must have a daylight drain or some other drainage mechanism to prevent floating of the cistern resulting from elevated groundwater levels.
8. Cisterns shall be protected from sunlight to inhibit algae growth and ensure life expectancy of tank.
9. All cistern openings shall be protected from unintentional entry by humans or vermin. Manhole covers shall be provided and shall be secured to prevent tampering. Where an opening is provided that could allow the entry of personnel, the opening shall be marked, "DANGER - CONFINED SPACE."
10. Cistern outlets shall be located at least 4 inches above the bottom of the cistern.
11. The cistern shall be equipped with an overflow device. The overflow device shall consist of a pipe equal to or greater than the cistern inlet and a minimum of 4 inches below any makeup device from other sources. The overflow outlet shall be protected with a screen having openings no greater than 0.25 inch or a self-sealing cover

Pumps and pressure tanks

Adequate elevation to deliver water from the storage tank to the filtration and disinfection system and the house at adequate pressure is often not available. Standard residential water pressure is 40-60 pounds per square inch. Two methods are used to attain proper pressure: 1) a pump with a pressure tank, pressure switch, and check valve; or 2) an on-demand pump. The first system uses the pressure tank to keep the system pressurized and the pressure switch initiates the pump when pressure falls below a predetermined level. The check valve prevents pressurized water from returning to the tank. The on-demand pump is self-priming and incorporates the pressure switch, pressure tank, and check valve functions in one unit (Texas Water Development Board, 2005).

Where a pump is provided in conjunction with the rainwater harvesting system, the pump shall meet the following provisions per WAC 51-56-1628.5:

1. The pump and all other pump components shall be listed and approved for use with potable water systems.
2. The pump shall be capable of delivering a minimum of 15 psi residual pressure at the highest outlet served. Minimum pump pressure shall allow for friction and other pressure losses. Maximum pressures shall not exceed 80 psi.

Back flow prevention

Rainwater is most commonly used to augment an existing potable supply for uses that don't require treatment to potable. Typically, such systems augment an existing supply because the cistern will likely run dry or near dry in the summer. Chapter 16 The Uniform Plumbing Code as adopted by Washington State has provisions that govern how to dual plumb such systems

to prevent backflow and subsequent contamination of the potable water supply.

Water treatment

Water treatment falls into three broad categories: filtration, disinfection, and buffering.

1. Filtration

Filters remove leaves, sediment, and other suspended particles and are placed between the catchment and the tank or in the tank. Filtering begins with screening gutters to exclude leaves and other debris, routing the first flush through first flush diverters, roof washers, and cistern float filters. Cistern float filters are placed in the storage tank and provide filtration as water is pumped from the tank to the disinfection system and the house (see figure 6.7.3). The filter is positioned to float 10-16 inches below the water surface where the water is cleaner than the bottom or surface of the water column (Texas Water Development Board, 2005).

Types of filters for removing the smaller remaining particles include single cartridges (similar to swimming pool filters) and multi-cartridge filters. These are typically 5-micron filters and provide final mechanism for removing fine particles before disinfection. Reverse osmosis and nanofiltration are filtration methods that require forcing water through a semi-permeable membrane. Membranes provide disinfection by removing/filtering very small particles (molecules) and harmful pathogens. Some water is lost in reverse osmosis and nanofiltration with concentrated contaminants. The amount of water lost is proportional to the purity of the feed water (Texas Water Development Board, 2005).

2. Disinfection

- *Ultra-violet (UV) radiation* uses short wave UV light to destroy bacteria, viruses, and other microorganisms. UV disinfection requires pre-filtering of fine particles where bacteria and viruses can lodge and elude the UV light. This disinfection strategy should be equipped with a light sensor and a readily visible alert to detect adequate levels of UV light (Texas Water Development Board, 1997).

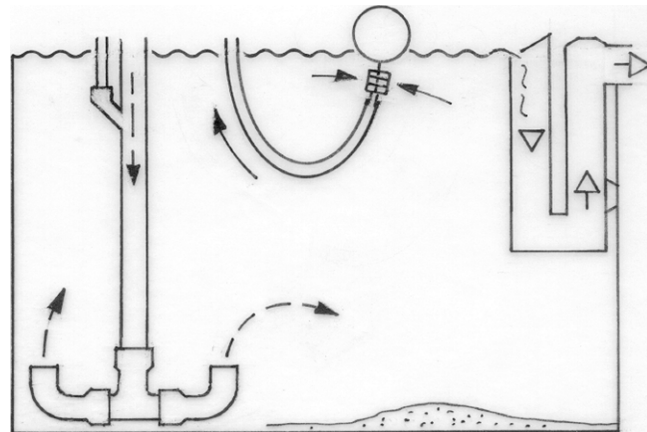

figure 6.7.3

Float filter for a rainwater collection cistern.
Source: Michael Brolli.

- *Ozone* is a form of oxygen produced by passing air through a strong electrical field. Ozone kills microorganisms and oxidizes organic material to CO₂ and water. The remaining ozone reverts back to dissolved O₂ (Texas Water Development Board, 1997). Care must be exercised in the choice of materials used in the system using this disinfection technique due to ozone's aggressive properties.
- *Activated carbon* removes chlorine and heavy metals, objectionable tastes, and most odors.
- *Chlorine* (commonly in the form of sodium hypochlorite) is a readily available and dependable disinfection technique. Household bleach can be applied in the cistern or feed pumps that release small amounts of solution while the water is pumped (Texas Water Development Board, 1997). There are two significant limitations of this technique: chlorine leaves an objectionable taste (this can be removed with activated charcoal); and prolonged presence of chlorine with organic matter can produce chlorinated organic compounds (e.g., trihalomethanes) that can present health risks (Texas Water Development Board, 1997).

6 6.7 Roof Rainwater Collection Systems

6.7.3 maintenance

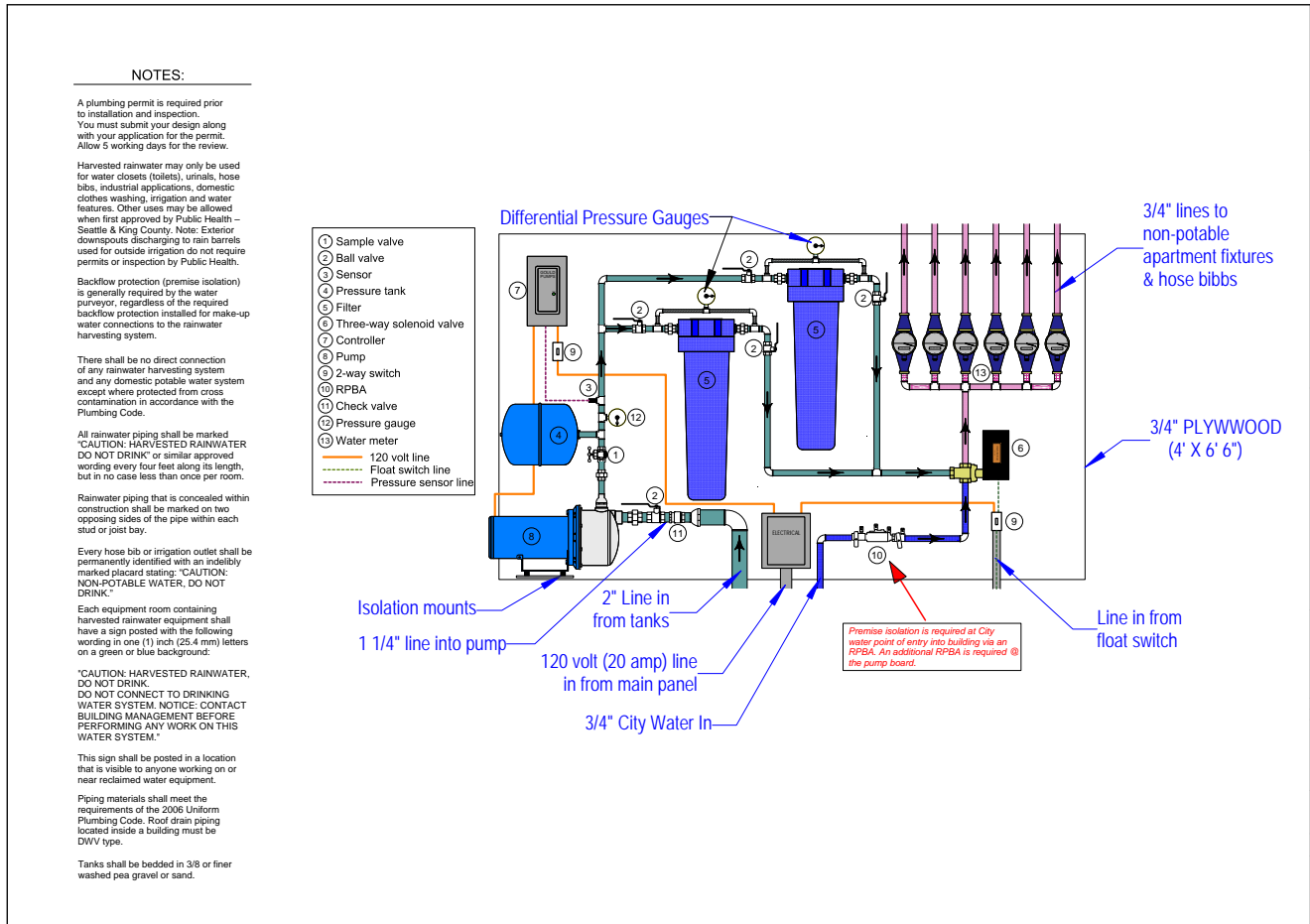

figure 6.7.4
Filter array for a residential rainwater harvesting system.
Source: *Living Systems Designs*

For potable systems, water must be filtered and disinfected after the water exits the storage reservoir and immediately before point of use (Texas Water Development Board, 2005).

3. Buffering

As stated previously, rainwater is usually slightly acidic (a pH of approximately 5.6 is typical). Total dissolved salts and minerals are low in precipitation, and buffering with small amounts of a common buffer, such as baking soda, can adjust collected rainwater to near neutral (Texas Water Development Board, 1997). Buffering should be done each fall after tanks have first filled.

6.7.3 Maintenance

Maintenance requirements for rainwater collection systems include typical household and system specific procedures. All controls, overflows, and cleanouts should be readily accessible and alerts for system problems should be easily visible and audible. The following procedures are operation and maintenance requirements recorded with the deed of homes using roof water harvesting systems in San Juan County (personal communication, Tim Pope, August 2004).

- Debris should be removed from the roof as it accumulates.
- Gutters should be cleaned as necessary (for example in September, November, January, and April. The most critical cleaning is in mid to late-

Spring to flush pollen deposits from surrounding trees.

- Screens at the top of the downspout should be maintained in good condition.
- Pre-filters should be cleaned monthly.
- Filters should be changed every six months or as a drop in pressure is noticed.
- UV units should be cleaned every six months and the bulb should be replaced every 12 months (or according to manufacturer's recommendation).
- Storage tanks should be chlorinated quarterly at 0.2 ppm to 0.5 ppm or a rate of 1/4 cup of household bleach (5.25 percent solution) to 1,000 gallons of stored water.
- Storage tanks should be inspected and debris removed periodically as needed.
- When storage tanks are cleaned, the inside surface should be rinsed with a chlorine solution of 1 cup bleach to 10 gallons water.
- When storage tanks are cleaned, the carbon filter should be removed and all household taps flushed until chlorine odor is noticed. Chlorinated water should be left standing in the piping for 30 minutes. Replace the carbon filter and resume use of the system.

6.7.4 Performance

In 2001, CH2M HILL performed an LID study on a 24-acre subdivision with 103 lots in Pierce County (CH2M HILL, 2001). The site was selected for its challenging conditions—medium density development (4-6 dwelling units/acre) located on a topographically closed depression area and type C soils (USDA soils classification) with low infiltration rates. The study utilized LID principles and practices to redesign the project (on paper) with the goal of approximating pre-development (forested) hydrologic conditions. LID practices used in the design included reducing the development envelope, minimizing impervious surfaces, increasing native soil and vegetation areas, amending disturbed soils with compost, and bioretention. Hydrologic analysis using continuous simulation (HSPF) was performed to assess the effectiveness of the selected LID practices for achieving the project goal.

The hydrologic simulations of the proposed LID design indicated that the goals of the project could not be fully achieved by site planning and reducing impervious surfaces alone while maintaining 4 or more dwelling units per acre. The challenging site conditions required that additional LID tools be utilized to approximate forested hydrology. Accordingly, rooftop rainwater harvest was considered to reduce surface flows. Important to note is that for the conventional project that was constructed at this site, additional property had to be purchased where stormwater was conveyed and retained because site conditions were extremely poor.

A 1,300-sq. ft. impervious footprint was used to reflect the compact, two-story design for the detached single-family homes. At this density the rooftop contributing to the total impervious surface in the development was almost 60 percent. Only non-potable uses such as laundry, toilet, and irrigation were investigated to reduce design costs and regulatory barriers. To estimate the storage volume required for non-potable uses, designers first evaluated the amount of water used inside the house. The average inside water use for homes that conserve water is approximately 49.2 gallons per person per day (Maddaus, William O., 1987, Water Conservation, American Water Works Association). See Table 6.7.1 for a breakdown of average daily water use per person/day.

Project designers considered using captured rainwater in toilets and washing machines. Stormwater collected from roof runoff may also be used for irrigation, but because of the small lot sizes this use was not factored into the calculation for storage requirements. However, the calculations assume that the storage system will be empty at the beginning of the wet season, so any excess stored water during the summer months should be used for irrigation.

6

6.7 Roof Rainwater Collection Systems

6.7.2 design

table 6.7.1 Household water use.

Type of Use	Gallons per Person per Day	Percent of Total*
Showers	8.2	17
Toilets	6.4	13
Toilet Leakage	4.1	8
Baths	7.0	14
Faucets	8.5	17
Dishwashers	2.4	5
Washing Machines	12.3	26

**The average inside water use for homes that conserve water is approximately 49.2 gallons per day.*

To estimate the amount of storage required, the volume of rainfall from a 1300-sq. ft. surface was plotted over time against curves showing water usage based on a 5-gallon toilet, a 3.3-gallon toilet, a low-flow toilet (1.6 gallon), and a low-flow toilet combined with a washing machine. Monthly average rainfall for Pierce County was used (41.5 inches annually). Although the 5-gallon toilet resulted in the smallest required storage volume, new construction requires the use of low-flow toilets, so the storage required for a combination low-flow toilet and washing machine was used. This resulted in a required storage volume of approximately 10,000 gallons, or 1,333 cu. ft. Accounting for evaporation and other inefficiencies in the collection process, the 103 houses on the LID site would capture and use approximately 8 acre-ft of water annually.

From a hydrologic standpoint, collecting and using rooftop runoff reduces or removes the roof contribution from the surface water system. Collecting the appropriate percentage of total precipitation can simulate the amount of water that is naturally transpired and evaporated in a forested environment. As a result, the surface water management system in the low impact development responds more like a forested system.

7

CHAPTER

Washington State Department of Ecology Low Impact Development Design & Flow Modeling Guidance

Guidance for Modeling with the Current WWHM 3	Part 1
Summary of WWHM 2012 Representation of LID Practices	Part 2
LID Sizing Tool for Western Washington Lowlands (GSI-Calc)	Part 3

The Department of Ecology requires the use of the Western Washington Hydrology Model (WWHM) and other approved runoff models for estimating surface runoff and sizing stormwater control and treatment facilities. Currently approved alternative models are the King County Runoff Time Series and MGS Flood. Part 1 of this chapter explains how to represent various LID techniques within WWHM3 so their benefit in reducing surface runoff can be estimated. The lower runoff estimates should translate into smaller or elimination of conventional stormwater treatment and flow control facilities. In certain cases, use of various techniques can result in the elimination of those facilities.

As Puget Sound gains more experience with and knowledge of LID techniques, the design criteria will evolve. Also, our ability to model their performance will change as our modeling techniques improve. Therefore, we anticipate this guidance will be updated periodically to reflect the new knowledge and modeling approaches.

7 Part 1: Guidance for Modeling

One such update should be available in late 2012. The updated guidance will explain modeling techniques to be used with the latest publicly available version of the WWHM (tentative name: WWHM 2012). A summary of the modeling techniques planned for WWHM 2012 is included in Part 2 of this chapter. Because WWHM 2012 and the updated LID modeling guidance won't be released until later 2012, municipal stormwater permittees are not obligated to require its use during the 2012-2013 and 2013-2018 permit terms. However, because WWHM 2012 will make modeling LID developments easier and more technically accurate, and because it will include a number of other updates and improvements (e.g., updated rainfall files), Ecology will encourage its use. We anticipate that most local governments will choose to require its use or an equivalent program (e.g., an updated MGS Flood) once they are readily available. Ecology intends to make sure that sufficient training opportunities are available on WWHM 2012 so that municipal staff and designers have adequate opportunity to become familiar with it prior to the deadlines in the municipal permits for adopting and applying updated stormwater requirements.

In previous editions of the 2012 SWMMWW, Appendix III-C included a summary of design criteria for each LID BMP. The reader is directed to Volume V of the 2012 SWMMWW and appropriate sections of this manual provided below for those design criteria.

PART 1: GUIDANCE FOR MODELING WITH THE CURRENT WWHM 3

7.1 Bioretention

See Section 6.1: Bioretention for design and construction guidelines

Entering each bioretention device and its drainage area into the approved computer models is preferable for estimating their performance. However, where site layouts involve multiple bioretention facilities, the modeling schematic can become extremely complicated or not accommodated by the available schematic grid. In those cases, multiple bioretention facilities with similar designs (i.e., soil depth, ponding depth, freeboard height, and drainage area to ponding area ratio), and infiltration rates (within a factor of 2) may have their drainage and ponded areas summed and represented in the runoff model as one drainage area and one bioretention device. In this case, a weighted average of the design infiltration rates at each location may be used. The averages are weighted by the size of their drainage areas. Each design infiltration rate is the measured infiltration rate multiplied by the appropriate correction (reduction) factors. For native soils below bioretention soils, a site variability correction factor (CF) should be considered.

7.1.1 Pothole design (bioretention cells)

Bioretention is represented by using the "Gravel trench/bed" icon with a steady-state infiltration rate. Proper infiltration rate selection is described below. The user inputs the dimensions of the gravel trench. Layer 1 on the input screen is the bioretention soil layer. Enter the soil depth and a porosity of 40 percent. Layer 2 is the free standing water above the bioretention soil. Enter the maximum depth of free standing water (i.e., up to the invert of an overflow pipe or a spillway, whatever engages first for surface release of water) and 100 percent for porosity. Bioretention with underlying perforated drain pipes that discharge to the surface can also be modeled as gravel trenches/beds with steady-state infiltration rates. However, the only volume available for storage (and modeled as storage as explained herein) is the void space within the imported

material (usually sand or gravel) below the bioretention soil and below the invert of the drain pipe.

Using one of the procedures explained in Volume III, Chapter 3 of the 2005 SWMMWW, estimate the initial measured (a.k.a., short-term) infiltration rate of the native soils beneath the bioretention soil and any base materials. Because these soils are protected from fouling, no correction factor need be applied.

If using the default bioretention soil media from Section 6.1 of this manual and Chapter 7 of Volume V of the 2012 SWMMWW, 6 inches per hour is the initial infiltration rate. The long-term rate is either 1.5 inches per hour or 3 inches per hour depending on the size of the drainage area into the bioretention facility. See Section 6.1 of this manual and Chapter 7 of Volume V of the 2012 SWMMWW. If using a custom imported soil mix other than the default, its saturated hydraulic conductivity (used as the infiltration rate) must be determined using the procedures described in Section 6.1 of this manual or Chapter 7 of Volume V of the 2012 SWMMWW. The long-term infiltration rate is $\frac{1}{4}$ or $\frac{1}{2}$ of that rate, depending on the size of the drainage area.

7.1.2 Linear design: (bioretention swale or slopes)

Where a swale design has a roadside slope and a back slope between which water can pond due to an elevated overflow drainage pipe at the lower end of the swale, the swale may be modeled as a gravel trench/bed with a steady state infiltration rate. This method does not apply to swales that are underlain by a drainage pipe.

If the long-term infiltration rate through the imported bioretention soil is lower than the infiltration rate of the underlying soil, the surface dimensions and slopes of the swale should be entered into the WWHM as the trench dimensions and slopes. The effective depth is the distance from the soil surface at the bottom of the swale to the invert of the overflow/drainage pipe. If the infiltration rate through the underlying soil is lower than the estimated long-term infiltration rate through the imported bioretention soil, the trench/bed dimensions

entered into the WWHM should be adjusted to account for the storage volume in the void space of the bioretention soil. Use 40 percent porosity for bioretention soil media recommended above for Layer 1 in WWHM.

This procedure to estimate storage space should only be used on bioretention swales with a 1 percent slope or less. Swales with higher slopes should more accurately compute the storage volume in the swale below the drainage pipe invert.

7.1.3 WWHM routing and runoff file evaluation for bioretention

In WWHM3, all infiltrating facilities must have an overflow riser to model overflows that occur should the available storage be exceeded. In the Riser/Weir screen, for the Riser head enter a value slightly smaller than the effective depth of the trench (e.g., 0.1 ft. below the Effective Depth), and for the Riser diameter enter a large number (e.g., 10,000 inches) to ensure there is ample capacity for overflows.

Within the model, route the runoff into the gravel trench by grabbing the gravel trench icon and placing it below the tributary “basin” area. Be sure to include the surface area of the bioretention area in the tributary “basin” area. Run the model to produce the effluent runoff file from the theoretical gravel trench. For projects subject to the flow control standard, compare the flow duration graph of that runoff file to the target pre-developed runoff file for compliance with the flow duration standard. If the standard is not achieved, a downstream retention or detention facility must be sized (using the WWHM standard procedures) and located in the field. A conveyance system should be designed to route all overflows from the bioretention areas to centralized treatment facilities, and to flow control facilities if flow control applies to the project.

7.1.4 Modeling of multiple bioretention facilities

Where multiple bioretention facilities are scattered throughout a development, it may be possible to cumulatively represent a group of them that have similar characteristics as one large bioretention facility serving the cumulative area tributary to those facilities. For this to be a reasonable representation, the design of each bioretention facility in the group should be similar (e.g., same depth of soil, same depth of surface ponded water, roughly the same ratio of impervious area to bioretention volume). In addition, the group should have similar (0.5x to 1.5x the average) controlling infiltration rates (i.e., either the long-term rate of the bioretention soil, or the initial rate of the underlying soil) that can be averaged as a single rate.

As an alternative, walks, patios, and driveways with little storage capacity in the underlying aggregate base can simply be entered as lawn/landscape areas in the continuous runoff model. Roads and parking lots that have storage in a base course below the wearing surface should use the permeable pavement element in the continuous runoff model.

The modeling approaches for various permeable pavement configurations are presented in Table 7.1.

7.2 Soil Quality and Depth

See Section 6.2: Amending Construction Site Soils for design and construction guidelines.

All areas that meet the soil quality and depth requirement may be entered into the model as pasture rather than lawn/landscaping.

7.3 Permeable Pavement

See Section 6.3: Permeable Pavement for design and construction guidelines.

In the runoff modeling, similar permeable pavement designs throughout a development can be summed and represented as one large facility. For instance, walkways can be summed into one facility. Driveways with similar designs (and enforced through deed restrictions) can be summed into one facility. In these instances, a weighted average of the design infiltration rates for each location may be used. The averages are weighted by the size of their drainage area. The design infiltration rate for each site is the measured infiltration rate multiplied by the appropriate correction factors. A site variability correction factor (CF) should be considered for native soils below permeable pavement.

table 7.1 permeable pavement configurations and model representation.

Description	Model surface as:
Porous Asphalt or Concrete	
1. Base material laid above surrounding grade	
a. Without underlying perforated drain pipes to collect stormwater	Grass over underlying soil type (till or outwash)
b. With underlying perforated drain pipes to collect stormwater	
<ul style="list-style-type: none"> • At or below bottom of base layer 	Impervious surface
<ul style="list-style-type: none"> • Elevated within the base course 	Impervious surface
2. Base material laid partially or completely below surrounding grade	
a. Without underlying perforated drain pipes	<i>Option 1:</i> grass over underlying soil type. <i>Option 2:</i> impervious surface routed to a Gravel Trench/Bed (see Section 7.3.2 for gravel trench representation details)
b. With underlying perforated drain pipes	
<ul style="list-style-type: none"> • At or below bottom of base layer 	Impervious surface
<ul style="list-style-type: none"> • Elevated within the base course 	If the perforated pipes are designed to distribute runoff directly below the wearing surface and the pipes are above the surrounding grade, then follow directions for 2a above; otherwise, Impervious surface routed to a Gravel Trench

7 Part 1: Guidance for Modeling

Description	Model surface as:
Permeable interlocking concrete pavement (PICP) and Plastic or Concrete Grid Systems (Note: this section refers to Grid \lattice systems (non-concrete) and Paving Blocks in Appendix III-C of the 2012 SWMMWW)	
1. Base material laid above surrounding grade	
a. Without underlying perforated drain pipes	<i>Plastic or concrete grid:</i> grass on underlying soil (till or outwash) <i>PICP:</i> 50% grass on underlying soil; 50% impervious
b. With underlying perforated drain pipes	<i>Plastic or concrete grid:</i> impervious surface <i>PICP:</i> impervious surface
2. Base material laid partially or completely below surrounding grade	
a. Without underlying perforated drain pipes	<u>Option 1</u> <i>Plastic or concrete grid:</i> grass on underlying soil (till or outwash) <i>PICP:</i> 50% grass; 50% impervious <u>Option 2</u> <i>Plastic or concrete grid:</i> impervious surface routed to a Gravel Trench/Bed <i>PICP:</i> impervious surface routed to a Gravel Trench/Bed (see Section 7.3.2 for gravel trench representation details)
b. With underlying perforated drain pipes	
<ul style="list-style-type: none"> At or below bottom of base layer 	Impervious surface
<ul style="list-style-type: none"> Elevated within the base course 	If the perforated pipes are designed to distribute runoff directly below the wearing surface and the pipes are above the surrounding grade, then follow directions for 2a above. Otherwise: <i>Plastic or concrete grid:</i> impervious surface routed to a Gravel Trench/Bed <i>PICP:</i> impervious surface routed to a Gravel Trench/Bed (see Section 7.3.2 for gravel trench representation details)

7.3.1 WWHM instructions for estimating runoff losses in road base material that are below surrounding grade

This section applies to roads or parking lots that have been constructed with a permeable pavement and whose underlying base materials extend below the surrounding grade of land. The over-excavated volume can temporarily store water before it infiltrates or overflows to the surrounding ground surface.

This section describes design criteria and modeling approaches for such designs.

Before using this guidance to estimate infiltration losses, the designer should have sufficient information to know whether adequate depth to seasonal high groundwater or other infiltration barrier (such as bedrock) is present. The minimum depth necessary is 3 feet as measured from the bottom of the base materials.

7.3.2 Instructions for roads on 0 to 2 percent grade

For road projects whose base materials extend below the surrounding grade, the below grade volume of base materials may be modeled in the WWHM as a Gravel Trench/Bed with a set infiltration rate. The pervious pavement area is entered as a basin with an equivalent amount of impervious area that is routed to the Gravel Trench/Bed.

First, place a “basin” icon in the “Schematic” grid. Enter the appropriate pre-developed and post-developed descriptions of your project site (or threshold discharge area of the project site). Assume that your pervious pavement surfaces are impervious surfaces. By placing a Gravel Trench/Bed icon below the basin icon in the Schematic grid, the road and any other tributary runoff is routed into the below grade volume that is represented by the Gravel Trench/Bed.

Enter the dimensions of the Gravel Trench/Bed, including: the length of the base materials that are below grade (parallel to the road); the width of the below grade material volume; and the depth. Note that the available storage is the void volume in the gravel

base layer below the permeable pavement. Enter the void ratio for the gravel base in the Layer 1 field. For example, for a project with a gravel base of 32 percent porosity, enter 0.32 for the Layer 1 porosity. If the below grade base course has perforated drainage pipes elevated above the bottom of the base course, but below the elevation of the surrounding ground surface, the “Layer 1 Thickness” is the distance from the invert of the lowest pipe to the bottom of the base course.

Also in WWHM3, the Gravel Trench/Bed facilities must have an overflow riser to model overflows that occur should the available storage be exceeded. For the “Riser Height”, enter a value slightly smaller than the effective depth of the base materials (e.g., 0.1 foot below the Effective Total Depth) and for the “Riser Diameter” enter a large value (e.g., 10,000 inches) to ensure there is ample capacity should overflows from the trench occur.

For all infiltration facilities, WWHM3 has a button that asks, “Use Wetted Surface Area?” The answer should remain “NO.”

Using one of the procedures explained in Volume III, Chapter 3 of the 2005 SWMMWW, estimate the initial measured (a.k.a., short-term) infiltration rate of the native soils beneath the base materials. Enter that into the “measured infiltration rate” field. For the Infiltration Reduction Factor, enter 0.5.

Run the model to produce the overflow runoff file from the Gravel Trench/Bed. Compare the flow duration graph of that runoff file to the target pre-developed runoff file for compliance with the flow duration standard. If the standard is not achieved, a downstream retention or detention facility must be sized (using the WWHM standard procedures) and located in the field. The road base materials should be designed to direct any water that does not infiltrate into a conveyance system that leads to the retention or detention facility.

7.3.3 Instructions for roads on grades above 2 percent

Road base material volumes that are below the surrounding grade and that are on a slope can be modeled as a Gravel Trench/Bed with an infiltration rate and a nominal depth. Represent the below grade volume as the gravel trench. Grab the gravel trench icon and place it below the “basin” icon so the computer model routes all runoff into the gravel trench.

The dimensions of the gravel trench are: the length (parallel to and beneath the road) of the base materials that are below grade; the width of the below grade base materials; and an Effective Total Depth of 1 inch. In WWHM3, all infiltrating facilities must have an overflow riser to model overflows that occur should the available storage be exceeded. Enter 0.04 foot (0.5 inch) for the “Riser Height” and a large Riser Diameter (e.g., 1000 inches) to ensure that there is no head build up.

If a drainage pipe is embedded and elevated in the below grade base materials, the pipe should only have perforations on the lower half (below the spring line) or near the invert. Pipe volume and trench volume above the pipe invert cannot be assumed as available storage space.

Estimate the infiltration rate of the native soils beneath the base materials. See Section 7.3.2: Instructions for roads on 0-2 percent grade for estimating options and for how to enter infiltration rates and infiltration reduction factors for the gravel trench. In the “Material Layers” field, enter 0.5 inch for Layer 1 Thickness and its appropriate porosity. For all infiltration facilities, WWHM3 has a button that asks, “Use Wetted Surface Area?” The answer should remain “NO.”

Run the model to produce the effluent runoff file from the gravel trench (base materials). Compare the flow duration graph of that runoff file to the target pre-developed runoff file for compliance with the flow duration standard. If the standard is not achieved, a downstream retention or detention facility must be sized (using the WWHM standard procedures) and located in the field. The road base materials should

be designed to direct any water that does not infiltrate into a conveyance system that leads to a retention or detention facility.

7.3.4 Instructions for roads on slopes with internal dams within the base materials that are below grade

In this design configuration, a series of infiltration basins is created by placing relatively impermeable barriers across the below grade base materials at intervals downslope. The barriers inhibit the free flow of water down the grade of the base materials. The barriers must not extend to the elevation of the surrounding ground. Provide a space sufficient to pass water from up-gradient to lower gradient basins without causing flows to surface out the sides of the base materials that are above grade.

Each length of trench or cell that is separated by barriers can be modeled as a gravel trench. This is done by placing the “Gravel Trench/Bed” icons in series in the WWHM. For each cell, determine the average depth of water within the cell (Average Cell Depth) at which the barrier at the lower end will be overtopped.

Specify the dimensions of the below-grade aggregate base materials for each cell using the “Gravel Trench/Bed” dimension fields for: the “Trench Length” (length of the cell parallel to the road); the “Trench Bottom Width”(width of the bottom of the base material); and the Effective Total Depth (the Average Cell Depth as determined above).

All infiltrating facilities must have an overflow riser to model overflows in WWHM3 should the available storage be exceeded. For each trench cell, the available storage is the void space within the Average Cell Depth. WWHM calculates the storage/void volume of the trench cell using the porosity values entered in the “Layer porosity” fields. The value for the Riser Height should be slightly below the “Effective Total Depth” (e.g., approximately 1/8” to 1/4”). For the Riser diameter, enter a large number (e.g., 10,000 inches) to ensure there is ample capacity should overflows from the below-grade trench occur.

Each cell should have its own tributary drainage area that includes the road above it, any project site impervious areas whose runoff drains onto and through the road, and any offsite areas. Each drainage area is represented with a “basin” icon.

Figure 7.1 is a computer graphic representation of a series of Gravel trench/beds and the basins that flow into them.

A series of cells can be represented as one infiltration basin (using a single gravel trench icon) if the cells all have similar length and width dimensions, slope, and Average Cell Depth. A single “basin” icon is also used to represent all of the drainage area into the series of cells.

On the Gravel Trench screen under “Infiltration”, there is a field that asks the following “Use Wetted Surface Area?” By default, it is set to “NO”. It should stay “NO” if the below-grade base material trench has sidewalls steeper than 2 horizontal to 1 vertical.

Using the procedures explained above for roads on zero grade, estimate the infiltration rate of the native soils beneath the trench. Also as explained above, enter the appropriate values into the “Measured Infiltration Rate” and “Infiltration Reduction Factor” boxes.

Run the model to produce the effluent runoff file from the below grade trench of base materials. Compare the flow duration graph of that runoff file to the target pre-developed runoff file for compliance with the flow duration standard. If the standard is not achieved, a downstream retention or detention facility must be sized (using the WWHM standard procedures) and located in the field. The road base materials should be designed to direct any water that does not infiltrate into a conveyance system that leads to a retention or detention facility.

7.4 Tree Retention and Planting

For guidelines on designing and planting trees for stormwater management in the urban and suburban environment see Section 6.4: Urban Trees.

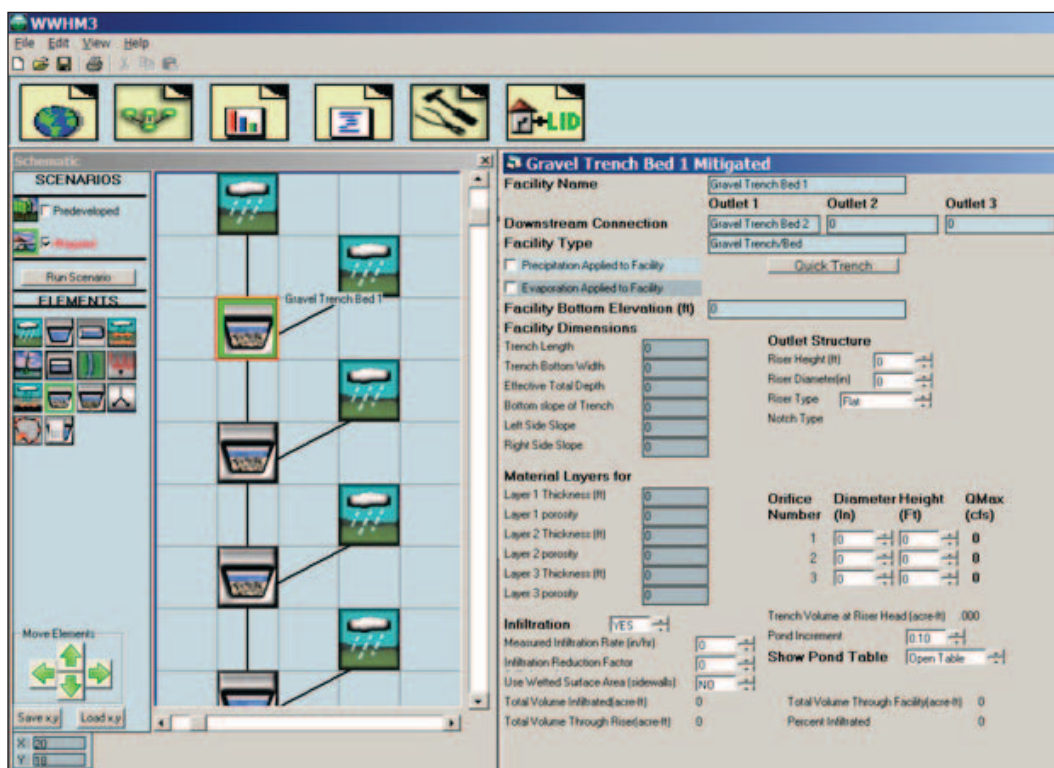

figure 7.1

Gravel Trench Bed representation in WWHM.
Source: WWHM

7.4.1 Flow control credit for retained trees

Flow control credits for retained trees are provided in Table 7.2 by tree type. These credits can be applied to reduce impervious or other hard surface area requiring flow control. Credits are given as a percentage of the existing tree canopy area. The minimum credit for existing trees ranges from 50-100 square feet.

Tree credits are not applicable to trees in native vegetation areas used for flow dispersion or other flow control credit. Credits are also not applicable to trees in planter boxes. The total tree credit for retained and newly planted trees shall not exceed 25 percent of impervious or other hard surface requiring mitigation.

table 7.2 flow control credits for retained trees

Tree Type	Credit
Evergreen	20% of canopy area (minimum of 100 sq. ft./tree)
Deciduous	10% of canopy area (minimum of 50 sq. ft./tree)

$$\text{Impervious Area Mitigated} = \sum \text{Canopy Area} \times \text{Credit (\%)} / 100.$$

7.4.2 Flow control credits for newly planted trees

Flow control credits for newly planted trees are provided in Table 7.3 by tree type. These credits can be applied to reduce the impervious or other hard surface area requiring flow control. Credits range from 20-50 square feet per tree.

table 7.3 flow control credits for newly planted trees

Tree Type	Credit
Evergreen	50 sq. ft. per tree
Deciduous	20 sq. ft. per tree

$$\text{Impervious Area Mitigated} = \sum \text{Canopy Area} \times \text{Credit (\%)} / 100.$$

Tree credits are not applicable to trees in native vegetation areas used for flow dispersion or other flow control credit. Credits are also not applicable to trees in planter boxes. The total tree credit for retained and newly planted trees shall not exceed 25 percent of impervious or other hard surface requiring mitigation.

7.5 Vegetated Roofs

See Section 6.5: Vegetated Roofs for design and construction guidelines

Two design options for flow control are applicable:

Option 1 Design Criteria: 3-8 inches of growing media. Runoff Model Representation

- 50 percent till landscaped area; 50 percent impervious area.

Option 2 Design Criteria: > 8 inches of growing media: Runoff Model Representation

- 50 percent till pasture; 50 percent impervious area.

7.6 Minimal Excavation Foundations

See Section 6.6: Minimal Excavation Foundations for design and construction guidelines.

Where residential roof runoff is dispersed on the up-gradient side of a structure in accordance with the design criteria and guidelines in BMP T5.10B of Volume III, Chapter 3 of the 2012 SWMMWW, the tributary roof area may be modeled as pasture on the native soil.

Where “step forming” is used on a slope, the square footage of roof that can be modeled as pasture must be reduced to account for lost soils. In “step forming,” the building area is terraced in cuts of limited depth. This results in a series of level plateaus to construct the foundation. The following equation (developed by Rick Gagliano of Pin Foundations, Inc.) can be used to reduce the roof area that can be modeled as pasture.

$$A_2 = A_1 - dC(.5) \times A_1 \div dP$$

Where:

A1 = roof area draining to up gradient side of structure.

dC = depth of cuts into the soil profile.

dP = permeable depth of soil (The A horizon plus an additional few inches of the B horizon where roots permeate into ample pore space of soil).

A2 = roof area that can be modeled as pasture on the native soil. The rest of the roof is modeled as impervious surface unless it is dispersed in accordance with below.

If roof runoff is dispersed down-gradient of the structure in accordance with the design criteria and guidelines in BMP T5.10B of Volume III, Chapter 3, and there is at least 50 feet of vegetated flow path through native material or lawn/landscape area that meets the guidelines in BMP T5.13 of Volume V, Chapter 5, the tributary roof areas may be modeled as landscaped area. Alternatively, use the lateral flow elements to send roof runoff onto the lawn/landscape area that will be used for dispersion.

7.7 Rainwater Harvesting

See Section 6.7: Roof Rainwater Collection Systems for design and construction guidelines.

Do not enter roof drainage area into the runoff model. Note: This applies only to the roof drainage areas for which a monthly water balance indicates no overflow of the storage capacity.

7.8 Dispersion

7.8.1 Full dispersion for the entire development site

Residential developments that implement BMP T5.30 from the 2012 SWMMWW do not have to use approved runoff models to demonstrate compliance. They are assumed to fully meet the treatment and flow control requirements.

7.8.2 Full Dispersion for part of the development site

Those portions of residential developments that implement BMP T5.30 do not have to use approved runoff models to demonstrate compliance. They are assumed to fully meet the treatment and flow control requirements.

7.8.3 Partial dispersion on residential lots and commercial buildings

If roof runoff is dispersed on single-family lots or commercial lots according to the design criteria and guidelines in BMP T5.10B of Volume III, and the vegetative flow path is 50 feet or greater through undisturbed native landscape or lawn/landscape area that meets the guidelines in BMP T5.13, the user has two options:

Option 1: The roof area may be modeled as landscaped area. This is done in the WWHM on the Mitigated Scenario screen by entering the roof area into one of the entry options for dispersal of impervious area runoff.

Option 2: Alternatively, the user may apply the “lateral flow icons.” In this option, the “Lateral Flow

Impervious Area” icon is used to represent the roof area(s). That icon is then connected to a “Lateral Flow Basin” icon that represents the pervious area into which the roof is being dispersed. The user should direct surface runoff and interflow from the “lateral flow basin” to a treatment system, retention/detention basin, or directly to a point of compliance.

Whether Option 1 or 2 is used, the vegetated flow path is measured from the downspout or dispersion system discharge point to the down-gradient edge of the vegetated area. That flow path must be at least 50 feet to use these options.

The same two options as described above are available where BMP T5.11 (concentrated flow dispersion) or BMP T5.12 (sheet flow dispersion) of Volume V, Chapter 5 of the 2012 SWMMWW is used to disperse runoff from impervious areas other than roofs into a native vegetation area or an area that meets the guidelines in BMP T5.13 of Volume V, Chapter 5 of the 2012 SWMMWW. The impervious area may be modeled as landscaped area or the “lateral flow” icons may be used. As above, the vegetated flow path from the dispersal point to the down-gradient edge of the vegetated area must be at least 50 feet.

PART 2: SUMMARY OF WWHM 2012 REPRESENTATION OF LID PRACTICES

7.9 Bioretention

The equations used in the new bioretention element (includes cell, swale and planter box) are intended to simulate the wetting and drying of soil as well as how the soils function once they are saturated. This group of LID elements uses the modified Green Ampt equation to compute the surface infiltration into the amended soil. The water then moves through the top amended soil layer at the computed rate, determined by Darcy’s and Van Genuchten’s equations. As the soil approaches field capacity (i.e., gravity head is greater than matric head), the model determines when water will begin to infiltrate into the second soil layer (lower layer). This occurs when the matric head is less than the gravity head in the first layer (top layer). The second layer is intended to prevent loss of the amended soil layer. As the second layer approaches field capacity, the water begins to move into the third layer – the gravel under-layer. For each layer the user inputs the depth of the layer and the type of soil.

For the default specifications recommended in Section 6.1 of this manual and Chapter 7 of Volume V of the 2012 SWMMWW, the model will automatically assign pre-determined values for parameters that determine water movement through each layer in the bioretention soil media column. These include: wilting point, minimum hydraulic conductivity, maximum saturated hydraulic conductivity, and Van Genuchten number.

If a user opts to use soils that deviate from the recommended specifications, the default parameter values do not apply. The user will have to use the Gravel Trench element to represent the bioretention facility and follow the procedures identified for WWHM3.

7.10 Post-Construction Soil Quality and Depth

Enter area as pasture.

7.11 Permeable Pavements

The user specifies pavement thickness and porosity, aggregate base material thickness and porosity, maximum allowed ponding depth, and infiltration rate into native soil. For grades greater than 2 percent, see additional guidance.

7.12 Newly Planted and Retained Trees

If BMP design criteria are followed, the total impervious/hard surface areas entered into the runoff model may be reduced by an amount described in Section 7.4.

7.13 Vegetated Roofs

The user specifies media thickness, vegetation type, roof slope, and length of drainage.

7.14 Minimal Excavation Foundations

Where residential roof runoff is dispersed on the upgradient side of a structure in accordance with the design criteria and guidelines in BMP T5.10B, the tributary roof area may be modeled as pasture on the native soil.

Where “step forming” is used on a slope, the square footage of roof that can be modeled as pasture must be reduced to account for lost soils. In “step forming,” the building area is terraced in cuts of limited depth. This results in a series of level plateaus on which the foundation is constructed. The following equation (suggested by Rick Gagliano of Pin Foundations, Inc.) can be used to reduce the roof area that can be modeled as pasture.

$$A_2 = A_1 - dC(.5) \times A_1 \text{ dP}$$

Where:

A1 = roof area draining to up gradient side of structure
dC = depth of cuts into the soil profile

dP = permeable depth of soil (The A horizon plus an additional few inches of the B horizon where roots permeate into ample pore space of soil).

A2 = roof area that can be modeled as pasture on the native soil. The rest of the roof is modeled as impervious surface unless it is dispersed in accordance with the guidelines below.

If roof runoff is dispersed down-gradient of the structure in accordance with the design criteria and guidelines in BMP T5.10B, AND there is at least 50 feet of vegetated flow path through native material or lawn/landscape area that meets the guidelines in BMP T5.13, the tributary roof areas should be modeled as a lateral flow impervious area. This is done in the WWHM on the Mitigated Scenario screen by connecting the dispersed impervious area to the lawn/landscape lateral flow soil basin element representing the area that will be used for dispersion.

Ecology may develop guidance for representing multiple downspout dispersions in a project site. If such guidance is not forthcoming, Ecology may allow the roof area to be modeled as a landscaped area so the project schematic in WWHM is manageable in situations where multiple downspout (downgradient) dispersions will occur.

7.15 Full Dispersion

If design criteria for BMP T5.30 are followed, the area draining to the dispersion area is not entered into the runoff model.

7.16 Rainwater Harvesting

Do not enter roof drainage area into the runoff model. Note: This applies only to the roof drainage areas for which a monthly water balance indicates no overflow of the storage capacity.

PART 3: LID SIZING TOOL FOR WESTERN WASHINGTON LOWLANDS (GSI-CALC)

GSI Calc is a simplified sizing tool for LID/GSI stormwater IMP design in western Washington lowlands. Green Stormwater Infrastructure (GSI) and LID are used synonymously in this manual. GSI Calc allows sizing of LID IMPs as a function of contributing impervious surface area, prevalent soil types in the region, representative site infiltration rates, and mean annual precipitation. This program was developed by Herrera Environmental Consultants through an Ecology Grant of Regional or Statewide Significance that was administered by Kitsap County. GSI Calc is intended to assist developers and regulatory agency reviewers in sizing and designing LID IMPs without need for continuous simulation modeling, thereby reducing the barriers to the implementation of LID.

A summary of GSI Calc is provided below. For more information, including step-by-step instructions on how to use the program, refer to the User's Manual (Herrera 2011a). This manual and the GSI-Calc program are available for download on the Washington Stormwater Center website.

7.18 GSI-Calc Applicability

GSI Calc can be used for projects that meet the following requirements:

- The site is located in the lowland areas of western Washington (i.e., up to approximately 1,500 feet in elevation).
- The project is subject to one of the following stormwater management standards included in GSI Calc:
 - » Ecology flow duration standard assuming a pre-developed forest land cover. This standard requires matching flow durations from half of the 2 year to the 50 year recurrence interval flows to a pre-developed forest condition (on till or outwash soil).

- » Ecology water quality treatment requirement for infiltration facilities. This standard requires infiltrating 91 percent of all runoff volume for the period modeled through soils meeting the Ecology treatment soil requirements.
- » Kitsap County groundwater recharge standard assuming a pre-developed forest land cover. The county requires maintaining the "recharge" (i.e., average annual volume of water that infiltrates to groundwater on a site) at or above pre-development levels.
- » Native soil design infiltration rates are greater than 0.125 inch per hour for sites predominantly underlain by till soil and greater than 0.5 inch per hour for sites predominantly underlain by outwash soil.
- » Drainage areas contributing runoff to IMPs are predominantly impervious.
- » The LID IMP design configurations included in GSI Calc are appropriate for site-specific stormwater management needs.

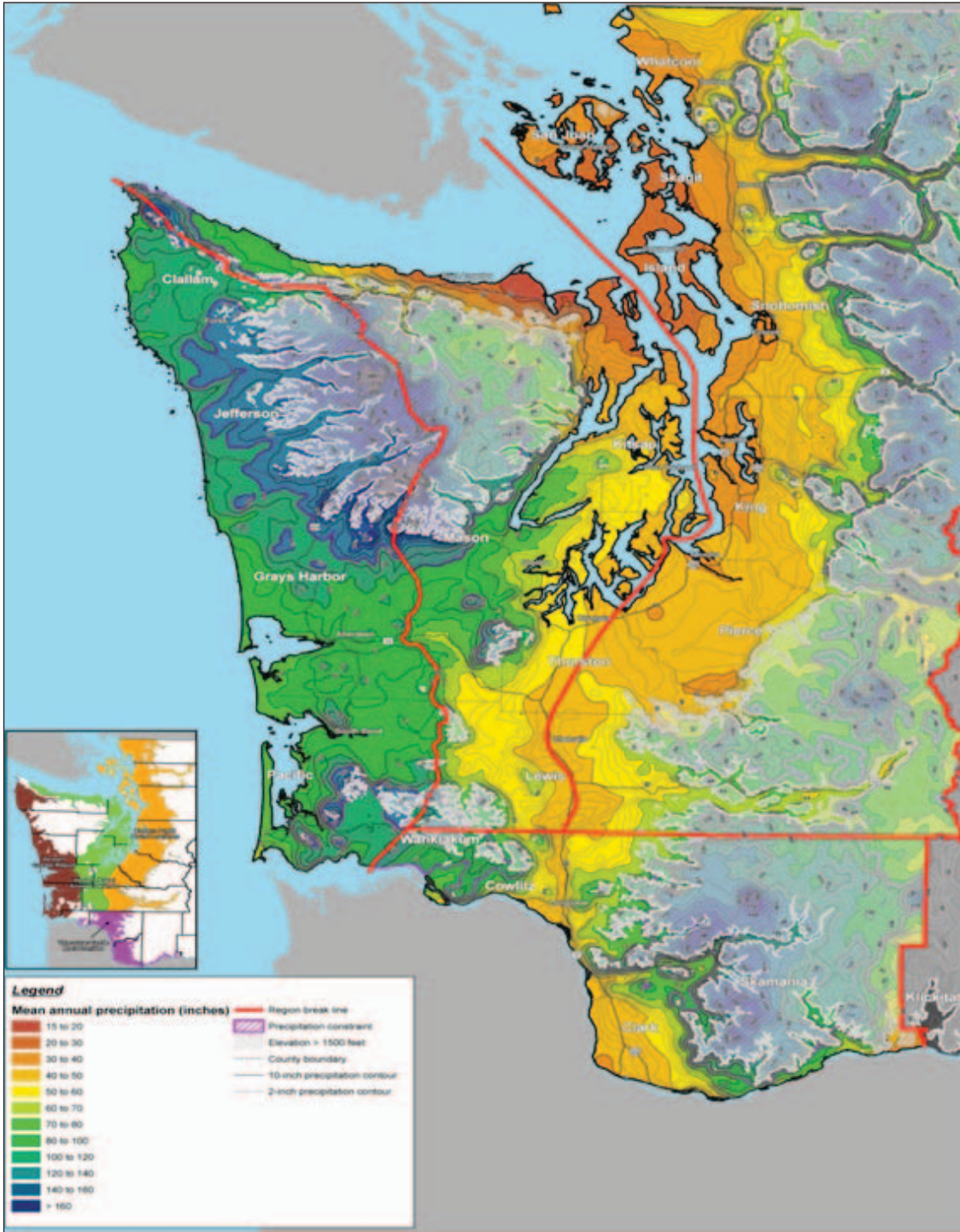

GSI-Calc coverage and mean annual precipitation in western Washington
 Source: Herrera

figure 7.2

7.19 GSI-Calc Development

To develop GSI Calc, continuous simulation hydrologic modeling was conducted to evaluate a suite of bioretention and permeable pavement facilities relative to selected stormwater management standards for the range of soil and climate conditions prevalent in the western Washington lowlands. Based on modeling results, simple mathematical relationships were developed that relate IMP performance to contributing impervious area, mean annual precipitation, soil type, and infiltration rate (see figure 7.3).

The IMP sizing equations were folded into the GSI-Calc computer program, which automates calculations (see figure 7.4) and provides standardized output for design review submittals. Detailed modeling methods and quality assurance measures are described in “Low Impact Development Best Management Practice Simplified Sizing Tool for Western Washington Lowlands — GSI Calc” (Herrera 2011b).

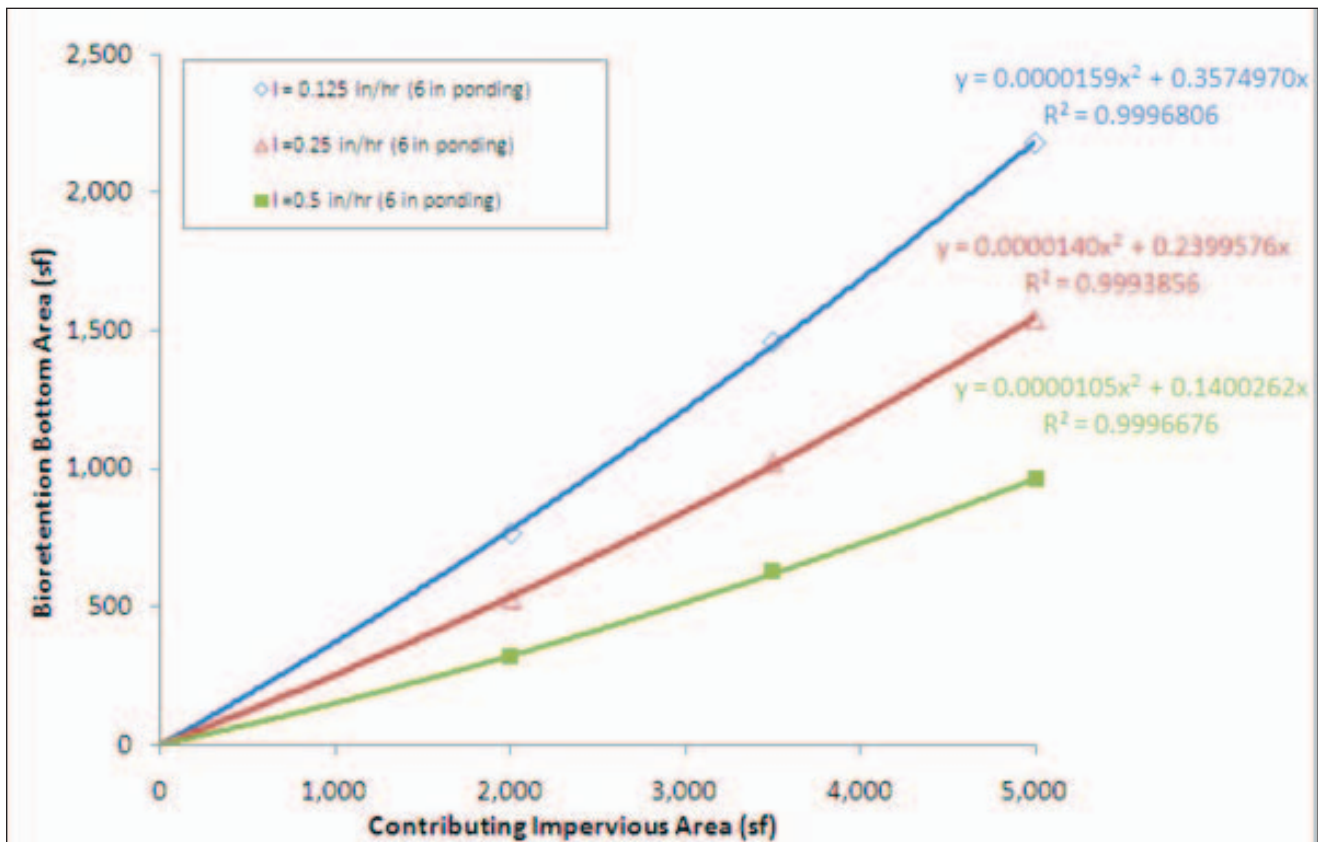

Example sizing relationships for bioretention cell (sized for Forest Duration Standard, site in western Puget Sound with 40" rainfall)
Source: Herrera

figure 7.3

Bioretention Cell (without underdrain)

	Ponding Depth (in)	Design Infiltration Rate (in/hr)	Bioretention Bottom Area (sf)	Notes	Area Mitigated (sf)
BR #1	6-inch	0.5	24	Bioretention in planting strip	2678
BR #2	12-inch	0.5	32	Bioretention cell on parcel	4685
BR #3	Select One	Select One			
BR #4	Select One	Select One			
Total					7363

OK

Design Requirements

Requirements

Expand Image

Bioretention Soil Mix (12" min. for Flow Control, 18" min. for Treatment, See Note 2)

Notes:

- Bottom width shall be a minimum of 2 feet and bottom area shall be flat (0% slope).
- Imported bioretention soil shall meet City of Seattle specifications.

Notes: in=inches, sf=square feet

GSI-Calc screen shot of a bioretention Input screen
Source: Herrera

figure 7.4

7.20 GSI BMPs and Design Requirements

GSI Calc can be used to size the following BMPs:

- **Bioretention:** Bioretention cell with 3-, 6- or 12-inch surface ponding depth and 3H:1V (horizontal to vertical) side slopes. GSI Calc provides the minimum cell bottom area for flow control or treatment.
- **Linear bioretention:** Bioretention cell with 3-, 6- or 12-inch surface ponding depth, 3H:1V side slopes and linear geometry (2-foot bottom width). GSI Calc provides the minimum cell bottom area for flow control or treatment.
- **Bioretention with under-drain:** Bioretention cell with 3-, 6- or 12-inch surface ponding depth, 3H:1V side slopes, and under-drain. GSI Calc provides the minimum cell bottom area for treatment.
- **Bioretention planter with under-drain:** Bioretention planter with 6- or 12-inch ponding depth, vertical side slopes, and under-drain. GSI Calc provides the minimum planter area for treatment.
- **Low slope permeable pavement:** Permeable pavement with sub-grade slope up to 2 percent (no run-on from other areas). GSI Calc provides the minimum aggregate storage depth for flow control purposes.
- **Higher slope permeable pavement:** Permeable pavement with sub-grade slope >2- 5 percent with subsurface measures to create ponding in the aggregate storage layer (no run-on from other areas). GSI Calc provides the minimum ponding depth within the aggregate storage layer for flow control purposes.

- Newly planted and retained trees: In addition to permeable pavement and bioretention BMPs, GSI Calc includes impervious surface reduction credits for newly planted trees and retained trees.

To use GSI Calc for facility sizing, IMPs must meet the design requirements outlined in the User's Manual. Requirements include design elements such as minimum permeable pavement aggregate porosity and bioretention soil characteristics.

7.21 Limitations and Future Updates

Generalized assumptions were used to develop this sizing tool that will result in conservative sizing for some sites. For example, the bioretention cell size was optimized for a square bottom geometry. As a result, using GSI-Calc to size bioretention cells with other bottom geometries will be conservative, particularly as the facility becomes more linear. In addition, IMPs were sized for a 100 percent impervious contributing drainage area. Therefore, if GSI-Calc is used to size an IMP for a mix of impervious and pervious drainage areas, the facility size will be conservatively large.

The scope of version 1 of GSI Calc was developed in conjunction with grant partners to maximize the benefits of GSI Calc given finite grant funding. Future versions of the GSI Calc tool could be developed to expand the options and applicability of the tool to meet ongoing regional needs in stormwater management and LID implementation.

Appendix One

Bioretention Plant List

1

The following table includes both native and non-native plant species commonly available in the Puget Sound region and suitable for bioretention cell and swale applications. Individual site characteristics and goals may exclude some species or require modifications or additions to plant suggestions provided here.

Bioretention cells and swales generally feature three planting zones characterized by soil moisture and periodic inundation during the growing season.

Zone 1: Area of periodic or frequent standing or flowing water. Many Zone 1 plants will also tolerate the seasonally dry periods of summer in the Northwest without extra watering and may also be applicable in Zone 2 or 3.

Zone 2: Periodically moist or saturated during larger storms. Plants listed under Zone 2 will also be applicable in Zone 3.

Zone 3: Dry soils, infrequently subject to inundation or saturation. This area should blend with the existing landscape.

* denotes native species

Special Considerations:

Drought tolerance – Several plants included on the list are not tolerant of dry conditions. When selecting these plants, it is important to consider that summer irrigation will be necessary.

Placement of large trees – Consider height, spread, and extent of roots at maturity. Use caution in plant selection for areas with under-drain pipes or other structures. If placed close to a road or driveway, consider potential for lower limbs to cause visibility or safety problems. See Appendix 1: Street Trees for more information on tree selection and placement suggestions.

Phytoremediation – A list of plants that have been studied for their ability to filter, absorb, and/or degrade specific contaminants is included in Appendix 5. While most of these plants are not included in the list below, varieties of some of the species known for phytoremediation are listed.

A1 ZONE 1

TREES SPECIES/ COMMON NAME	EXPOSURE	MATURE SIZE/ SPREAD	TIME OF BLOOM	COMMENTS
<i>Alnus rubra</i> * Red alder	Sun/partial shade	30-120 feet/ 25 ft. spread		Prefers moist, rich soils, highly adaptable, drought-tolerant; nitrogen fixer; rapid growing, relatively short-lived (60-90 years)
<i>Salix lucida</i> * Pacific willow	Sun	40-60 feet/ 30 ft. spread		Wet soils; tolerates seasonal flooding; should not be planted in areas near pavement or underground structures
<i>Fraxinus latifolia</i> * Oregon ash	Sun/partial shade	40-80 feet/ 30 ft. spread		Moist, saturated or ponded soils; flood tolerant; small green-white flowers
<i>Malus fusca</i> * Pacific crabapple	Sun/partial shade	To 40 feet/ 35 ft. spread	Spring	Tolerant of prolonged soil saturation; produces fruit (do not plant near public walkways)

SHRUBS SPECIES/ COMMON NAME	EXPOSURE	MATURE SIZE/ SPREAD	TIME OF BLOOM	COMMENTS
<i>Lonicera involucrata</i> * Black twinberry	Partial shade/ shade	2-8 feet	April-May	Moist soils; prefers loamy soils; tolerant of shallow flooding; yellow, tubular flowers attract hummingbirds
<i>Myrica californica</i> * Pacific wax myrtle	Sun/partial shade	To 30 feet	May-June	Evergreen shrub preferring moist soils; inconspicuous spring flowers; drought-tolerant; if drought tolerance is not an issue try the smaller Washington native, <i>Myrica gale</i> *
<i>Physocarpus capitatus</i> * Pacific ninebark	Sun/partial shade	6-13 feet	May-June	Moist or dry soils; drought-tolerant; "snowball" shaped shrub; white flowers; seeds persist into winter
<i>Rosa pisocarpa</i> * Clustered wild rose	Sun/partial shade	6-8 feet	May-July	Moist soils, tolerates seasonal flooding but also tolerant of dry conditions; pink clustered flowers; fruits persist
<i>Salix purpurea</i> 'Nana' Dwarf Artic willow	Sun/partial shade	3-5 feet		Grows well in poor soils; moderately drought-tolerant; small yellow flowers in the fall
<i>Spiraea douglasii</i> * <i>Douglas spirea</i> Steeplebush	Sun/partial shade	4-7 feet		Moist or dry, to seasonally inundated soils; spikes of small, pink flower clusters

EMERGENTS SPECIES/ COMMON NAME	EXPOSURE	MATURE SIZE/ SPREAD	TIME OF BLOOM	COMMENTS
<i>Carex obnupta</i> * Slough sedge	Sun/partial shade	1-5 feet		Moist to seasonally saturated soils; shiny foliage; excellent soil binder; drought-tolerant
<i>Carex stipata</i> * Sawbeak sedge	Partial shade	10 inches- 3 feet		Wet soils; excellent soil binder
<i>Juncus effusus</i> * Common rush	Sun/partial shade	1-2 feet	Summer	Wet soils; evergreen perennial; hardy and adaptable; drought-tolerant; small, non-showy flowers
<i>Juncus ensifolius</i> * Daggerleaf rush	Sun	12-18 inches		Wet soils; shallow water; excellent soil binder
<i>Juncus tenuis</i> * Slender rush	Sun	.5-2.5 feet		Moist soils; tufted perennial
<i>Scirpus acutus</i> * Hardstem bulrush	Sun	4-8 feet		Wet soils; favors prolonged inundation; excellent soil binder
<i>Scirpus microcarpus</i> * Small-fruited bulrush	Sun/shade	2-4 feet		Wet soils; tolerates prolonged inundation; good soil binder; drought- tolerant

A1 ZONE 2

TREES SPECIES/ COMMON NAME	EXPOSURE	MATURE SIZE/ SPREAD	TIME OF BLOOM	COMMENTS
<i>Acer truncatum</i> Pacific sunset maple	Sun	To 25 feet/ 20 ft. spread		Prefers moist, well-drained soils, but drought-tolerant; very cold hardy; deciduous tree with moderate growth rate
<i>Amelanchier alnifolia</i> * Western serviceberry	Sun/partial shade	10-20 feet/ 25 ft. spread	April-May	Moist to dry, well-drained soils; drought-tolerant; large white flowers; purple to black berries; deciduous
<i>Corylus cornuta</i> * Beaked hazelnut	Sun/partial shade	20-30 feet/ 15 ft. spread	April-May	Moist, well-drained soils; edible nuts; intolerant of saturated soils; catkins throughout winter add interest; deciduous
<i>Crataegus douglasii</i> * Black hawthorn	Sun/partial shade	3-30 feet/ 25 ft. spread	Spring	Moist to dry, well drained, gravelly soils; small white flowers, black berries; 1" spines; forms thickets; deciduous
<i>Fraxinus oxycarpa</i> Raywood ash	Sun	25-50 feet/ 25 ft. spread	Spring	Drought-tolerant; grows in varying soil types; deciduous; can take extreme temperatures; does not tolerate constant wind or fog; resists pests and disease better than do non-native ashes; inconspicuous flowers
<i>Rhamnus purshiana</i> * Cascara sagrada	Sun/shade	20-40 feet/ 25 ft. spread		Moist to fairly dry soils; small greenish-yellow flowers; deciduous; sensitive to air pollution; yellow fall color
<i>Salix scouleriana</i> * Scouler willow	Sun/partial shade	6-40 feet/ 15 ft. spread		Moist to dry soils; drought-tolerant; deciduous tree; do not plant near paved surfaces or underground structures
<i>Salix sitchensis</i> * Sitka willow	Sun/partial shade	3-26 feet/ 25 ft. spread		Moist soils; tolerates seasonal flooding; deciduous tree; do not plant near paved surfaces or underground structures
<i>Thuja plicata</i> * Western red cedar	Partial shade/ shade	200 feet+/ 60 ft. spread		Moist to swampy soils; tolerates seasonal flooding and saturated soils; long-lived; prefers shade while young

SHRUBS DECIDUOUS SPECIES/ COMMON NAME	EXPOSURE	MATURE SIZE/ SPREAD	TIME OF BLOOM	COMMENTS
<i>Acer circinatum</i> * Vine maple	Filtered sun/ shade	To 25 feet	Spring	Dry to moist soils; tolerant of shade and clay soils; excellent soil binder; beautiful fall color
<i>Hamamelis intermedia</i> Diane Diane witchhazel	Sun/partial shade	10-20 feet/ 10 ft. spread	January- March	Moist, fertile, acidic soil; showy fall color – yellow to yellow-orange; long-lasting, slightly fragrant, coppery-red flowers; not drought-tolerant; may require watering in dry season
<i>Oemleria cerasiformis</i> * Indian plum/Osoberry	Sun/partial shade	5-16 feet	February- March	Moist to dry soils; prefers shade; tolerates fluctuating water table
<i>Philadelphus x lemoinei</i> 'Belle Etoile' Mock-orange	Sun/partial shade	5-6 feet	May-June	Prefers moist, well-drained soils, high in organic matter, but soil and pH adaptable; easily transplanted and established; fragrant, large white flowers, tinged red at the base; other cultivars available
<i>Ribes lacustre</i> * Black swamp gooseberry	Partial shade	1.5-3 feet		Moist soils; deciduous shrub; reddish flowers in drooping clusters; dark purple berries; <i>R. divaricatum</i> * (Wild gooseberry) grows to 5 feet and is also an option; attracts butterflies, but is very thorny
<i>Rosa nutkana</i> * Nootka rose	Sun/partial shade	6-10 feet	April-June	Moist to fairly dry soils; tolerates inundation and saturated soils; aggressive spreader; fruits persist; less thorny than <i>R. rugosa</i>
<i>Rosa rugosa</i> (mixed varieties)	Sun	To 8 feet		Drought resistant; hardy, vigorous and aggressive; highly prickly; fragrant white to purple flowers; fruits persist
<i>Rubus parviflorus</i> * Thimbleberry	Sun/partial shade	4-10 feet	May-June	Moist to dry soils; white flowers; red berries; makes thickets and spreads easily
<i>Rubus spectabilis</i> * Salmonberry	Partial sun/ shade	5-10 feet	February- April	Prefers moist, wet soils; good soil binder; magenta flowers; yellow/orange fruit; early nectar source for hummingbirds; makes thickets

A1 ZONE 2

SHRUBS DECIDUOUS SPECIES/ COMMON NAME	EXPOSURE	MATURE SIZE/ SPREAD	TIME OF BLOOM	COMMENTS
<i>Sambucus racemosa</i> * Red elderberry	Partial sun/ partial shade	To 20 feet	April-May	Moist to dry soils; small white flowers; bright red berries; vase shaped; pithy stems lead to “messy” form – prune for tidiness
<i>Symphoricarpos albus</i> * Snowberry	Sun/partial shade	2-6 feet		Wet to dry soils, clay to sand; excellent soil binder; drought and urban air tolerant; provides good erosion control; spreads well in sun; white berries; flowers attract hummingbirds
<i>Vaccinium parvifolium</i> * Red huckleberry	Partial shade/shade	4-10 feet		Slightly moist to dry soils; prefers loamy, acid soils or rotting wood; tolerant of dry, shaded conditions; red fruit; tricky to transplant

HERBACEOUS SPECIES/ COMMON NAME	EXPOSURE	MATURE SIZE/ SPREAD	TIME OF BLOOM	COMMENTS
<i>Aquilegia formosa</i> * Western columbine	Sun/partial shade	1-3 feet	Spring	Moist soils of varying quality; tolerant of seasonal flooding; red and yellow flowers attract hummingbirds and butterflies
<i>Asarum caudatum</i> * Wild ginger	Partial shade/ shade	To 10 inches	Mid Spring	Moist organic soils; heart-shaped leaves; reddish-brown flowers
<i>Aster chilensis</i> * Common California aster	Sun	1.5-3 feet	June- September	Moist soils; white to purple flowers
<i>Aster subspicatus</i> * Douglas' aster	Sun	.5 - 2.5 feet	June- September	Moist soils; blue to purple flowers
<i>Camassia quamash</i> * Common camas	Sun/partial shade	To 2.5 feet	May-June	Moist to dry soils; lots of watering needed to establish; loose clusters of deep blue flowers

HERBACEOUS SPECIES/ COMMON NAME	EXPOSURE	MATURE SIZE/ SPREAD	TIME OF BLOOM	COMMENTS
<i>Camassia leichtlinii</i> Giant camas		2-4 feet	May-June	Moist to dry soils; lots of watering to establish; large clusters of white, blue or greenish-yellow flowers
<i>Iris douglasiana</i> * Pacific coast iris	Sun/partial shade	1-2 feet	Spring	Tolerates many soils; withstands summer drought and seasonal flooding; white, yellow, blue, reddish purple flowers; fast growing; velvety purple flowers; vigorous
<i>Iris foetidissima</i> Gladwin iris	Sun/partial shade	1-2 feet	May	Moist to dry, well-drained soils; pale lilac flower; also called Stinking Iris
<i>Juncus tenuis</i> * Slender rush	Sun	6 inches-2.5 feet		Moist soils; yellow flowers
<i>Iris sibirica</i> Siberian Iris	Sun	1-2.5 feet	Late Spring-early Summer	Moist soils; deep blue, purple to white flowers
<i>Tellima grandiflora</i> * Fringecup	Partial sun/shade	1-3 feet	March-June	Perennial preferring moist soils; yellowish-green to pink flowers
<i>Tiarella trifoliata</i> * Foamflower	Partial sun/shade	To 1 foot	Early-mid Summer	Moist soils; perennial with some drought tolerance after established; can form dense colonies; white flowers
<i>Tolmiea menziesii</i> * Youth-on-age/Piggy-back plant	Partial shade/shade	1-2 feet	April - August	Moist soils; brownish-purple flowers; also makes an effective ground cover
<i>Viola species</i> * Violets	Partial shade/shade	6-12 inches	Late Spring-early Summer	Moist soils; yellow to blue flowers

A1 ZONE 3

TREES SPECIES/ COMMON NAME	EXPOSURE	MATURE SIZE/ SPREAD	TIME OF BLOOM	COMMENTS
<i>Cornus spp.</i> Dogwood	Sun/partial shade	20 - 30 feet/ 30 ft. spread	May	Reliable flowering trees with attractive foliage and flowers; may need watering in dry season; try <i>C. florida</i> (Eastern dogwood), or <i>C. nuttallii</i> * (Pacific dogwood) or hybrid 'Eddie's White Wonder'. Also, <i>C. kousa</i> for small tree/shrub which is resistant to anthracnose
<i>Prunus emarginata</i> * Bitter cherry	Sun/partial shade	20 - 50 feet/ 20 ft. spread	May-June	Dry or moist soils; intolerant of full shade; purple to black cherries; bright fruits are attractive to birds; roots spread extensively
<i>Prunus virginiana</i> Choke cherry		3 - 25 feet/ 15-20 ft. spread	late Spring- early Summer	Dry or moist soils; deep rooting; attractive white fragrant flowers; good fall color
<i>Pseudotsuga menziesii</i> * Douglas-fir	Sun	100-250 feet/ 50-60 ft. spread		Does best in deep, moist soils; evergreen conifer with medium to fast rate of growth; provides a nice canopy, but potential height will restrict placement
<i>Quercus garryana</i> * Oregon white oak	Sun	To 75 feet		Dry to moist, well-drained soils; slow growing; acorns

TREES EVERGREEN SPECIES/ COMMON NAME	EXPOSURE	MATURE SIZE/ SPREAD	TIME OF BLOOM	COMMENTS
<i>Arbutus unedo</i> Strawberry tree	Sun/partial shade	8-35 feet/ 8-20 ft. spread	November- December	Tolerant of extremes; tolerant of urban/industrial pollution; white or greenish white flowers
<i>Calocedrus decurrens</i> * Incense cedar	Sun	75-90 feet/ 12 ft. spread		Tolerant of poor soils; drought-tolerant after established; fragrant evergreen with a narrow growth habit; slow growing
<i>Chamaecyparis obtusa</i> Hinoki false cypress	Sun/partial shade	40-50 feet/ 15-30 ft. spread		Moist, loamy, well-drained soils; very slow growing; prefers sun, but tolerates shade; does not transplant well or do well in alkaline soils. Note there are many alternative varieties of false cypress of varying sizes and forms from which to choose.
<i>Pinus mugo</i> Swiss mountain pine	Sun/partial shade	15-20 feet/ 25-30 ft. spread		Prefers moist well-drained soil; slow growing, broadly spreading, bushy tree; hardy evergreen
<i>Pinus thunbergiana</i> Japanese black pine	Sun	To 100 feet/ 40 ft. spread		Dry to moist soils; hardy; fast growing

SHRUBS SPECIES/ COMMON NAME	EXPOSURE	MATURE SIZE/ SPREAD	TIME OF BLOOM	COMMENTS
<i>Holodiscus discolor</i> * Oceanspray	Sun/partial shade	To 15 feet	June-July	Dry to moist soils; drought-tolerant; white to cream flowers; good soil binder
<i>Philadelphus lewisii</i> * Mock-orange	Sun/partial shade	5-10 feet	June-July	Adapts to rich moist soils or dry rocky soils; drought-tolerant; fragrant flowers

A1 ZONE 3

SHRUBS SPECIES/ COMMON NAME	EXPOSURE	MATURE SIZE/ SPREAD	TIME OF BLOOM	COMMENTS
<i>Pinus mugo pumilio</i> Mugho pine	Sun	3-5 feet/ 4-6 ft. spread		Adapts to most soils; slow growing and very hardy; newer additions with trademark names such as 'Slo-Grow' or 'Lo-Mound' are also available
<i>Potentilla fruticosa</i> Shrubby cinquefoil	Sun	To 4 feet	May- September	Moist to dry soils; several cultivars available with varying foliage and flower hues; try 'Tangerine' or 'Moonlight'
<i>Potentilla gracilis*</i> Graceful cinquefoil	Sun	1-2 feet	July	Moist to dry soils; yellow flowers
<i>Ribes sanguineum*</i> Red-flowering currant	Sun/partial shade	8-12 feet	March- April	Prefers dry soils; drought-tolerant; white to deep-red flowers attract hummingbirds; dark-blue to black berries; thornless
<i>Rosa gymnocarpa*</i> Baldhip rose	Partial shade	To 6 feet	May-July	Dry or moist soils; drought-tolerant; small pink to rose flowers

SHRUBS EVERGREEN SPECIES/ COMMON NAME	EXPOSURE	MATURE SIZE/ SPREAD	TIME OF BLOOM	COMMENTS
<i>Abelia x grandiflora</i> Glossy abelia	Partial Sun/ Partial shade	To 8 feet/ 5 foot spread	Summer	Prefers moist, well-drained soils, but drought-tolerant; white or faintly pink flowers
<i>Arbutus unedo</i> 'Compacta'	Sun/partial shade	To 10 feet	Fall	Prefers well drained soils; tolerant of poor soils; good in climate extremes; white to greenish-white flowers; striking red-orange fruit

SHRUBS EVERGREEN SPECIES/ COMMON NAME	EXPOSURE	MATURE SIZE/ SPREAD	TIME OF BLOOM	COMMENTS
<i>Cistus purpureus</i> Orchid rockrose	Sun	To 4 feet	June-July	Moist to dry well-drained soils; drought resistant; fast growing; reddish purple flowers
<i>Cistus salviifolius</i> White rockrose	Sun	2-3 feet/ 6 ft spread	Late Spring	Moist to dry well-drained soils preferred, but can tolerate poor soils; tolerant of windy conditions and drought; white flowers
<i>Escallonia x exoniensis 'fradesii'</i> Pink princess	Sun/partial sun	5-6 feet	Spring-Fall	Tolerant of varying soils; drought-tolerant when established; pink to rose colored flowers; good hedge or border plant; attracts butterflies
<i>Osmanthus delavayi</i> Delavay Osmanthus	Sun/partial shade	4-6 feet	March-May	Tolerant of a broad range of soils; attractive foliage and clusters of white fragrant flowers; slow growing
<i>Osmanthus x burkwoodii</i> Devil wood	Sun/partial shade	4-6 feet	March-April	Drought-tolerant once established; masses of small, white fragrant flowers
<i>Rhododendron</i> 'PJM' hybrids	Sun/partial shade	To 4 feet	Mid-late April	Moist to fairly dry soils; well drained organic soil; lavender to pink flowers
<i>Stranvaesia davidiana</i>	Sun	6-20 feet	June	Moist soils; white flowers in clusters; showy red berries
<i>Stranvaesia davidiana undulata</i>	Sun	To 5 feet	June	Moist soils; lower growing irregularly shaped shrub; great screening plant
<i>Vaccinium ovatum</i> * Evergreen huckleberry	3-15 feet	March		Moist to slightly dry soils; small pinkish-white flowers; berries in August

A1 ZONE 3

GROUNDCOVER EVERGREEN SPECIES/ COMMON NAME	EXPOSURE	MATURE SIZE/ SPREAD	TIME OF BLOOM	COMMENTS
<i>Arctostaphylos uva-ursi</i> * Kinnikinnick	Sun/partial shade		April-June	Prefers sandy/rocky, well-drained soils; flowers pinkish-white; bright red berries; slow to establish; plant closely for good results
<i>Gaultheria shallon</i> * Salal	Partial shade/shade	3-7 feet	March-June	Dry and moist soils; white or pinkish flowers; reddish-blue to dark-purple fruit
<i>Fragaria chiloensis</i> * Wild/Coastal strawberry	Sun/partial shade	10 inches	Spring	Sandy well drained soils; flowers white; small hairy strawberries; evergreen; aggressive spreader
<i>Helianthemum nummularium</i> Sunrose	Sun	To 2 feet/ 2 ft. spread	May-July	Prefers moist, well-drained soils, but will tolerate various soils; low-growing, woody perennial; many varieties are available with flowers in salmon, pink, red, yellow and golden colors.
<i>Lavandula angustifolia</i> Lavender	Sun/partial shade	To 1.5 feet	June-August	Adaptable to various soils; blue, lavender, pink to white flowers, semi-evergreen aromatic perennial
<i>Mahonia nervosa</i> * Cascade Oregon grape/Dull Oregon grape	Partial shade/shade	To 2 feet	April-June	Dry to moist soils; drought resistant; evergreen; yellow flowers; blue berries
<i>Mahonia repens</i> Creeping mahonia	Sun/partial shade	3 feet	April-June	Dry to moist soils; drought resistant; yellow flowers; blue berries; native of Eastern Washington
<i>Penstemon davidsonii</i> * Davidson's penstemon	Sun	To 3 inches	June-August	Low growing evergreen perennial; prefers well-drained soils; drought-tolerant; blue to purple flowers

PERENNIALS & ORNAMENTAL GRASSES SPECIES/ COMMON NAME	EXPOSURE	MATURE SIZE/ SPREAD	TIME OF BLOOM	COMMENTS
<i>Achillea millefolium</i> * Western yarrow	Sun	4 inches- 2.5 feet	June- September	Dry to moist, well-drained soils; white to pink/reddish flowers; many other yarrows are also available
<i>Anaphalis margaritacea</i> Pearly everlasting	Sun/partial shade	To 18 inches		Drought-tolerant perennial; spreads quickly; attracts butterflies
<i>Bromus carinatus</i> * Native California brome	Sun/partial shade	3-5 feet		Dry to moist soils; tolerates seasonal saturation
<i>Carex buchananii</i> Leather leaf sedge	Sun/partial shade	1-3 feet		Prefers moist, well-drained soils; copper-colored foliage; perennial clumping grass; tolerant of a wide range of soils; inconspicuous flowers
<i>Carex comans</i> 'Frosty curls' New Zealand hair sedge	Sun/partial shade	1-2 feet	June- August	Prefers moist soils; finely textured and light green; compact, clumping perennial grass; drought-tolerant when established; inconspicuous flowers
<i>Coreopsis</i> spp.	Sun	1-3 feet		Dry to moist soils; drought-tolerant; seeds attract birds; annual and perennial varieties; excellent cut flowers
<i>Echinacea purpurea</i> Purple coneflower	Sun	4-5 feet		Prefers well drained soils; hardy perennial; may need watering in dry months
<i>Elymus glaucus</i> * Blue wildrye	Sun/partial shade	1.5-5 feet		Dry to moist soils; shade tolerant; rapid developing, but short lived (1-3 years); not good lawn grass
<i>Dicentra formosa</i> * Pacific bleeding-heart	Sun/shade	6-20 inches	Early Spring -early Summer	Moist, rich soils; heart-shaped flowers

A1 ZONE 3

PERENNIALS & ORNAMENTAL GRASSES SPECIES/ COMMON NAME	EXPOSURE	MATURE SIZE/ SPREAD	TIME OF BLOOM	COMMENTS
<i>Erigeron speciosus</i> * <i>Showy fleabane</i>	Sun/partial shade	To 2 feet	Summer	Moist to dry soils; dark violet or lavender blooms; fibrous roots
<i>Festuca ovina</i> 'Glauca' <i>Blue fescue</i>	Sun/partial shade	To 10 inches	May-June	Prefers moist, well-drained soils; blue-green evergreen grass; drought-tolerant; shearing will stimulate new growth
<i>Festuca idahoensis</i> * <i>Idaho fescue</i>	Sun/partial shade	To 1 foot		Bluish-green bunching perennial grass; drought-tolerant
<i>Fragaria vesca</i> * <i>Wood strawberry</i>	Partial shade	To 10 inches	Late Spring - early Summer	Dry to moist soils; white flowers
<i>Gaultheria shallon</i> * <i>Salal</i>	Sun/shade	3-7 feet	March-June	Dry and moist soils; white or pinkish flowers; reddish-blue to dark-purple fruit
<i>Gaura lindheimeri</i> <i>Gaura</i>	Sun	2.5-4 feet		Perennial; fairly drought-tolerant and adaptable to varying soil types; long blooming period
<i>Geum macrophyllum</i> * <i>Large-leaved avens</i>	Sun/partial shade	To 3 feet	Spring	Moist, well-drained soil; bright yellow flowers; other <i>Geum</i> cultivars available, some which may require supplemental watering
<i>Geranium maculatum</i> <i>Spotted geranium</i>	Sun/shade	To 1.5 feet	July	Moist, well-drained soils; low perennial; pale pink, blue to purple flowers
<i>Geranium sanguineum</i> <i>Cranesbill</i>	Sun/partial shade	To 1.5 feet	May-August	Moist soils; deep purple almost crimson flowers
<i>Helichrysum italicum</i> <i>Curry Plant</i>	Sun	To 2 feet	Summer	Moist or dry soils; hardy evergreen perennial; a good companion to lavender; bright yellow flowers; fragrant
<i>Helictotrichon sempervirens</i> <i>Blue oat grass</i>	Sun/partial shade	1-1.5 feet	June-August	Tolerant of a variety of soil types but prefers well-drained soil; clumping bright blue evergreen grass; bluish white flowers

PERENNIALS & ORNAMENTAL GRASSES SPECIES/ COMMON NAME	EXPOSURE	MATURE SIZE/ SPREAD	TIME OF BLOOM	COMMENTS
<i>Hemerocallis fulva</i> Day lilies	Sun/partial shade	1-4 feet	Summer	Tolerant of a variety of soil types; easy to grow and tolerant of neglect; hardy perennial; entire plant is edible
<i>Heuchera americana</i> Coral bells (alumroot)	Sun/partial shade	1-2 feet	June-August	Moist to dry, well-drained soils; never wet; easily transplantable perennial; red, greenish-white flowers; may need supplemental watering in dry season
<i>Heuchera micrantha</i> 'Palace purple' (alumroot)	Sun/partial shade	1-2 feet	June-August	Moist, well-drained soils; bronze to purple foliage in shade; small, yellowish-white flowers; perennial, evergreen; a number of other species and varieties are available. Try <i>H. sanguinea</i> for bright red flowers
<i>Lupinus*</i> Lupines	Sun	3-5 feet	March-September	Moist to dry soils; various native varieties; blue to purple, violet to white flowers; both native and non-native varieties
<i>Lupinus bicolor*</i> Two-color lupine	Sun	4 inches-1.5 feet	Spring	Dry gravelly soils; small-flowered; annual
<i>Lupinus latifolius*</i> Broadleaf lupine	Sun	To 1 foot	June-August	Dry to moist soils; perennial; bushy herb; bluish flowers
<i>Lupinus polyphyllus*</i> Large-leaved lupine	Sun	To 3 feet	Spring-Summer	Dry to moist, sandy to gravelly soils; perennial
<i>Mahonia aquifolium*</i> Tall Oregon grape	Sun/partial shade	6-10 feet	March-April	Dry to moist soils; drought resistant; evergreen; blue-black fruit; bright yellow flowers; 'Compacta' form averages 2 feet tall; great low screening barrier
<i>Maianthemum dilatatum*</i> False lily-of-the-valley	Partial shade/shade	3-12 inches	Spring	Prefers moist soils; small, white flowers; light-green to red berries

A1 ZONE 3

PERENNIALS & ORNAMENTAL GRASSES SPECIES/ COMMON NAME	EXPOSURE	MATURE SIZE/ SPREAD	TIME OF BLOOM	COMMENTS
<i>Pennisetum alopecuroides</i> Fountain grass	Sun/partial shade	1-2 feet	August -September	Moist, well-drained soils; tolerant of many soil types; clump forming grasses. A number of varieties are available in different heights and bloom times. Try <i>P. caudatum</i> (White-flowering fountain grass) and <i>P. alopecuroides</i> cultivars 'Hameln' and 'Little bunny' (Dwarf fountain grass)
<i>Pennisetum orientale</i> Oriental fountain grass	Sun/partial shade	1-3 feet	June-October	Prefers moist, well-drained soils; somewhat drought-tolerant; small clumping, blooming grass, showy pink flowers; fountain grasses will benefit from annual shearing in late winter/early spring, but not required
<i>Penstemon fruticosus</i> Bush penstemon	Sun	8-10 inches	May	Prefers well-drained soils; evergreen perennial; drought-tolerant; violet-blue flowers 1" long attract hummingbirds
<i>Polystichum munitum</i> * Swordfern	Partial shade/ Deep shade	2-4 feet		Prefers moist, rich soil conditions, but drought-tolerant; large evergreen fern
<i>Rudbeckia hirta</i> Black-eyed susan	Sun/partial shade	3-4 feet	Summer	Moist to dry soils; showy flowers, hardy and easy to grow; several other varieties are available
<i>Smilacina racemosa</i> * False Solomon's seal	Partial sun/ shade	1-3 feet	April-May	Moist soils; creamy white flowers; red berries
<i>Solidago canadensis</i> * Canadian goldenrod	Sun/partial shade	1-2 feet	Late Summer-early Fall	Dry to moist soils; yellow flowers

Bog Garden Plants

A bog garden presents a unique design option for managing stormwater on site. A lined depression featuring an organic soil mix and wetland vegetation can be an attractive method for promoting evaporation and transpiration of collected runoff. A functioning bog garden generally displays no standing water, but soils are saturated much of the time, necessitating facultative wetland plant selections.

To select plant species appropriate for a bog garden, refer to those listed in Zone 1 above as well as those found in the following table. The list below includes native and non-native plant species (not listed in the Bioretention Plant List) that have been successfully applied in a Pacific Northwest bog garden setting. It may be necessary to provide additional water to the bog system during seasonal dry periods due to a lack of stormwater runoff.

As with any system, plant species in a bog garden setting have various preferences for moisture and sun. Check listed comments below and research plant needs to optimize successful growth in the conditions specific to individual bog garden systems.

BOG GARDEN SPECIES/ COMMON NAME	EXPOSURE	MATURE SIZE	TIME OF BLOOM	COMMENTS
<i>Adiantum aleuticum</i> * Western maidenhair fern	Shade/ partial shade	1-2 feet		Moist to wet soils; graceful, delicate fern; vivid bright green with black stems; spreads through creeping rhizomes; often called <i>A. pedatum</i> , but this refers to the related East Coast maidenhair fern; also try <i>A. capillis-veneris</i> (Venus-hair fern)
<i>Andromeda polifolia</i> * Bog rosemary	Sun/partial shade	1-1.5 feet	Spring	Moist to wet soils; low-growing evergreen shrub; white to pink flower clusters; ornamental varieties include 'Blue Ice', 'Grandiflora' and 'Nana'
<i>Blechnum spicant</i> * Deer fern	Shade/ partial shade	1-3 feet		Moist to wet soils; has both evergreen and deciduous leaves; prefers soils high in organic material; is sensitive to frost

A1 Bog Garden

BOG GARDEN SPECIES/ COMMON NAME	EXPOSURE	MATURE SIZE	TIME OF BLOOM	COMMENTS
<i>Carex</i> ssp. Sedges	Sun/shade	varies		A number sedge choices are great options for a bog garden setting; two are listed in Appendix 3 – Zone 1, but there are many alternative species to investigate, including <i>Carex mertensii</i> * (Mertens' sedge) and <i>C. lyngbyei</i> * (Lyngby's sedge)
<i>Cornus sericea</i> * Red-osier dogwood Red-twig dogwood	Sun/partial shade	To 15 feet		Prefers wet to moist organically rich soils, but is adaptable; tolerates seasonal flooding; multi-stemmed, deciduous shrub with red fall color; small white flowers; bluish-white berries in the fall; see Appendix 3 – Zone 1 listing for additional cultivars
<i>Eleocharis palustris</i> * Creeping spike-rush	Sun	To 3.5 feet		Wet soils to shallow water; perennial forming small clumps
<i>Empetrum nigrum</i> * Crowberry	Sun	To 8 inches	Early Spring	Dry to wet/boggy soils; low-growing evergreen shrub; small purplish flowers and purplish-black berries
<i>Equisetum hyemale</i> * Scouring-rush	Sun/partial shade	2-5 feet		Moist to wet soils; hollow-stemmed, evergreen perennial; spreads through creeping rhizomes; vigorous and persistent; with high silica content; also <i>E. scirpoides</i> (Dwarf horsetail); use both with caution – <i>Equisetum</i> can be very invasive and difficult to remove once established
<i>Gaultheria ovatifolia</i> * Oregon wintergreen/ Western teaberry	Partial shade	To 1 foot	Late Spring - Summer	Moist to wet soils; low-growing evergreen shrub; pink or whitish flowers and red berries; also <i>G. humifusa</i> * (Alpine wintergreen)
<i>Glyceria elata</i> * Tall mannagrass	Sun/partial shade	3-4.5 feet		Moist to wet soils; loosely tufted perennial, spreads through creeping rhizomes; also try the taller <i>G. grandis</i> * (Reed mannagrass)
<i>Gunnera manicata</i> Gunnera	Sun/partial shade	4-6 feet/ 4-8 ft. spread		Moist to wet organic soils; prefers humid setting; non-native from Brazil and Columbia needing mulching protection in the winter; also referred to as 'giant rhubarb'; huge rounded leaves; needs plenty of space; also <i>G. tinctoria</i> from Chile

Bog Garden A1

BOG GARDEN SPECIES/ COMMON NAME	EXPOSURE	MATURE SIZE	TIME OF BLOOM	COMMENTS
<i>Hakonechloa macra</i> Japanese forest grass	Shade/partial shade	1-3 feet		Prefers moist, rich soil; slowly spreading perennial grass; green leaves turn coppery orange in the fall
<i>Hosta</i> Plantain lily	Shade/partial sun	To 2.5 feet	Summer	Prefer moist, rich soil; many varieties and hybrids available in a various sizes, foliage textures and colors; thin spikes of blue or white flowers; some are tolerant of sun, but most prefer shade
<i>Juncus ssp.</i> Rushes	Sun/shade	varies		As with the <i>Carex</i> species, there are a number of native rushes that would work well in a bog garden. Three options are listed in Appendix 3 – Zone 1; others to investigate include <i>Juncus mertensianus</i> * (Mertens' rush) and <i>J. acuminatus</i> * (Tapered rush)
<i>Kalmia occidentalis</i> * Swamp-laurel	Sun	.5-2 feet	Spring-early Summer	Also known as <i>K. polifolia</i> , prefers moist soils; low shrub with aromatic leaves; rose-purple flowers; also try <i>K. microphylla</i> * (Western bog-laurel) a mat-forming, evergreen shrublet; generally found in wet subalpine conditions
<i>Ledum groenlandicum</i> * Labrador tea	Shade/partial sun	1.5-4.5 feet	Summer	Moist to boggy soils; evergreen shrub with small white flower clusters; foliage aromatic when crushed
<i>Ligularia dentata</i> Bigleaf ligularia	Shade/partial shade	3-5 feet	Summer	Moist to wet soils; large-leaved, clumping perennial; yellow-orange blooms; not tolerant of high heat or low humidity; try <i>L. dentata</i> cultivars 'Othello' and 'Desdemona'; also <i>L. przewalskii</i> (Shavalski's ligularia) and <i>L. stenocephala</i> (Narrow-spiked ligularia)
<i>Linnaea borealis</i> * Twinflower	Shade/partial shade	4-6 inches	June-September	Moist or dry soils; evergreen perennial; pink, fragrant, trumpet-like flowers; trailing ground cover; try <i>L. borealis</i> on the less saturated margins of a bog garden; may be difficult to establish

A1 Bog Garden

BOG GARDEN SPECIES/ COMMON NAME	EXPOSURE	MATURE SIZE	TIME OF BLOOM	COMMENTS
<i>Lobelia cardinalis</i> Cardinal flower	Sun/partial shade	2-4 feet	Summer	Wet to moist, rich soils; clumping perennial; tubular, bright red, inch-long flowers; also try <i>L. siphilitica</i> (Blue lobelia), another perennial with blue flowers
<i>Lysichiton americanum*</i> Skunk cabbage	Shade/partial shade	2-3 feet	March	Prefers wet soils; deciduous perennial; what some consider to be a skunky odor especially when blooming; yellow hooded fleshy flower spike; great leaves dominate
<i>Matteuccia struthiopteris</i> Ostrich fern	Sun/shade	To 6 feet		Moist, rich soils; hardy northern fern; clumping narrowly at base with foliage spreading to 3 feet in width
<i>Mimulus ssp.</i> Monkey-flower	Sun/partial shade	1-3 feet	Spring- Summer	Wet soils; perennial or annual that reseeds nicely and keeps spreading; many species available including natives, <i>M. guttatus*</i> (Yellow monkey-flower) and <i>M. tilingii*</i> (Mountain monkey-flower); also <i>M. lewisii*</i> with rose-red to pale-pink flowers
<i>Myrica gale*</i> Sweet gale	Sun/partial shade	To 4 feet		Moist to wet soils; aromatic, deciduous perennial shrub; glossy green leaves; a nitrogen fixing species
<i>Oplopanax horridum</i> Devil's club	Shade/partial sun	3-10 feet		Moist to wet soils; forms extensive clumps; aggressive grower, but huge palmate leaves highly decorative; clusters of small whitish flowers; wand-like stems have sharp spines
<i>Osmunda cinnamomea</i> Cinnamon fern	Sun/partial shade	2-5 feet		Moist to wet soils; large deciduous fern; unfolding 'fiddlehead' fronds are edible
<i>Oxycoccus oxycoccus*</i> Bog cranberry	Sun	4-16 inches		Moist to wet soils, prefers Sphagnum moss mats, peat and acidic conditions; evergreen, low-creeping vine like shrub; pink to red flowers; red berries; shade intolerant

BOG GARDEN SPECIES/ COMMON NAME	EXPOSURE	MATURE SIZE	TIME OF BLOOM	COMMENTS
Polystichum munitum* Sword fern	Shade/partial shade	2-5 feet		Moist soils; large evergreen fern; dark green fronds with dagger shaped leaflets; hardy and easy to grow
Potentilla palustris* Marsh cinquefoil		To 3 feet		Moist to wet soils; perennial with reddish-purple flowers; stems both prostrate and ascending
Ribes divaricatum* Wild gooseberry	Partial shade/ shade	1.5-6.5 feet		Prefers wet or moist soils; green or purple flowers and smooth, dark purple berries; a hedge or screen provides good habitat for birds and wildlife; beware prickly spines; also try R. lacustre* (Black gooseberry)
Salix arctica* Arctic willow	Sun/shade	To 2 feet	Spring	Moist soils; deciduous, prostrate or trailing shrub; leaves are dark green on the bottom and lighter on top; brownish to pink flowers; see Appendix 3 – Zone 1 listing for details on S. purpurea 'Nana'
Trientalis arctica* Northern starflower	Shade/partial shade	To 8 inches		Wet, boggy soils; small perennial; star-shaped white flowers, or with a pink tinge

SOURCES

- Azous, A.L., and Horner, R.R. (Eds.). (2001). *Wetlands and urbanization: Implications for the future*. Boca Raton, FL: Lewis Publishers.
- Brenzel, K.N. (Ed.). (2001). *Sunset western garden book*. Menlo Park, CA: Sunset Publishing Corporation.
- Broili, Michael, Well Home Program Director. Personal communication, May 2004.
- Crawford, C. (1982). *Wetland plants of King County and Puget Sound lowlands*. King County, WA: King County Resource Planning Section.
- DeWald, S. City of Seattle S.E.A. Streets tree schedule and planting schedule. <http://www.cityofseattle.net/util/naturalsystems/plans.htm#SEA>
- Greenlee, J. and Fell, D. (1992). *The encyclopedia of ornamental grasses*. Emmaus, PA: Rodale Press.

A1 Sources

- Guttman, Erica. Washington State University/Thurston County Extension Office. Native Plant Salvage Coordinator. Personal communication, May 2004.
- Hogan, E.L. (Ed.). (1990). *Sunset western garden book*. Menlo Park, CA: Lane Publishing Co.
- Johnson, Jim, and DeWald, Shane. *Appropriate plants for swales and rain gardens* (Broadview Green Grid). Seattle, WA: City of Seattle.
- Kruckeberg, A.R. (1996). *Gardening with native plants* (2nd ed.). Seattle, WA: University Press.
- Leigh, M. (June 1999). *Grow your own native landscape: A guide to identifying, propagating & landscaping with Western Washington plants*. Native Plant Salvage Project, WSU Cooperative Extension – Thurston, County.
- Metro. (June 2002). *Green streets: Innovative solutions for stormwater and stream crossings*. Portland, OR: Author.
- Pojar, J. and MacKinnon, A. (1994). *Plants of the Pacific Northwest Coast: Washington, Oregon, British Columbia and Alaska*. Renton, WA: Lone Pine Publishing.
- Puget Sound Action Team. (2003, March). *Natural approaches to stormwater management: Low impact development in Puget Sound*. Olympia, WA: Author.
- U.S. Forest Service, FEIS Information webpage. <http://www.fs.fed.us/database/feis/plants/>
- University of Florida, Environmental Horticulture. <http://hort.ifas.ufl.edu/trees/>
- Washington State Department of Ecology. (2001 June). *An aquatic plant identification manual for Washington's freshwater plants*. Olympia, WA, Author.
- Weinmann, F., Boule, M., Brunner, K., Malek, J., & Yoshino, V. (1984). *Wetland plants of the Pacific Northwest*. Seattle, WA: U.S. Army Corps of Engineers, Seattle District.

Appendix Two Street Tree List

2

The following list provides information on the growth patterns and favorable site characteristics for trees that are appropriate in the street landscape. Bioretention cells and swales located along streets may have specific soil and moisture conditions that differ from conventional roadside planting areas. Trees in this list may be applicable in bioretention areas depending on the physical setting and project objectives. See Appendix 1 for trees specifically recommended in bioretention cells or swales.

Local jurisdictions often have specific guidelines for the types and location of trees planted along public streets or rights-of-way. The extent and growth pattern of the root structure must be considered when trees are planted in bioretention areas or other stormwater facilities with under-drain structures or near paved areas, such as driveways, sidewalks or streets. The City of Seattle, for example, has the following requirements for tree planting location:

- 3½ feet back from the face of the curb.
- 5 feet from underground utility lines.
- 10-15 feet from power poles.
- 7½-10 feet from driveways.
- 20 feet from street lights or other existing trees.
- 30 feet from street intersections.
- Planting strips for trees should be at least 5 feet wide.

Trees included in the “small” tree section of this list typically remain at or below a 30-foot mature height, which is compatible (unless indicated otherwise) with clearances for most overhead utility/electrical lines. Some jurisdictions may not recommend planting street trees that are fruit bearing or are otherwise “messy”. Contact local authorities to determine if there are guidelines or restrictions to consider when making tree selections in your area.

Minimum ranges for planting strip widths are included and are compiled from various local and regional jurisdiction recommendations. Generally, larger planting widths are recommended for optimal tree health and longevity. Under certain circumstances, the use of root barriers or root guards may assist in preventing or delaying damage to adjacent paved surfaces. Consult a certified arborist for specifications and information on root barriers and installation.

Note on conifers: Often jurisdictions recommend very large planting areas for conifers due to potential visibility or safety issues associated with lower limbs. However, conifers can be incorporated safely into the urban streetscape and provide excellent year-round interception of precipitation if properly trimmed and maintained.

A2 Small Trees



indicates a tree that does well in wet areas

* denotes native species

SMALL TREES (UNDER 30 FEET IN HEIGHT) SPACE EVENLY EVERY 20 TO 30 FEET				
SPECIES/ COMMON NAME	EXPOSURE	MATURE HT./ SPREAD	PLANTING STRIP WIDTH	COMMENTS
<i>Acer campestre</i> Hedge maple	Sun/partial shade	To 30 feet/ To 30 ft. spread	4-5 feet	Deciduous; prefers moist, rich soils; slow growing tree tolerant of air pollution and soil compaction; yellow fall color; cultivars available including Queen Elizabeth maple ('Evelyn') with dark green, glossy foliage
<i>Acer circinatum</i> * Vine maple	Sun/partial shade	20-25 feet/ 10 ft. spread	8 feet	Deciduous; prefers moist, well-drained soils; tolerates seasonal saturation and varying soil types; drought tolerant once established; bushy shrub or small tree; most often multi-trunked and does well in small groups; white flowers April-June; orange and red fall color
<i>Acer ginnala</i> Amur maple	Sun/partial shade	To 20 feet/ 20 ft. spread	4 feet	Deciduous; prefers moist, well-drained soils, but is tolerant of drought; is often multi-trunked, but can be pruned to a single stem; rounded form; fragrant, yellowish-white flowers in spring; cultivars are available such as 'Flame' and 'Embers' with differing fall colors
<i>Acer griseum</i> Paperbark maple	Sun/partial shade	15-25 feet/ 15-25 ft. spread	4 feet	Deciduous; prefers moist, well-drained soils, but is moderately drought tolerant; bronze peeling bark provides year-round visual interest; often multi-trunked, but can be trained to a single stem; scarlet fall color; slow growing; disease and pest resistant
<i>Acer palmatum</i> Japanese maple	Partial shade/ Sun	15-25 feet/ 10-25 ft. spread	4 feet +	Prefers moist, well-drained soils; deciduous; slow to moderate growth rate; multi-trunked with spreading branches; intolerant of inundation but moderately drought resistant; vibrant fall colors; many cultivars available including 'Emperor I', 'Katsura', and 'Osakazuki'

SMALL TREES (UNDER 30 FEET IN HEIGHT) SPACE EVENLY EVERY 20 TO 30 FEET				
SPECIES/ COMMON NAME	EXPOSURE	MATURE HT./ SPREAD	PLANTING STRIP WIDTH	COMMENTS
Acer platanoides 'Globosum' Globe Norway maple	Sun/partial shade	15-20 feet/ 15-20 ft. spread	4-5 feet +	Moist soils preferred, but tolerates drought and seasonal inundation; tolerant of urban pollution; dense, compact, round form; slow-growing deciduous tree with brilliant fall color; shallow root system may make mowing under the tree slightly difficult; good selection for locations under power lines; another cultivar well suited for such a location is A. platanoides 'Almira,' reaching only 20-25 ft.
Acer triflorum Roughbark maple	Sun/partial shade	25-30 feet/ 20-25 ft. spread	Check with jurisdiction	Deciduous; prefers moist soils, but somewhat drought tolerant once established; apricot and gold fall color; rough, knobby trunk provides interest in winter; disease and pest resistant; non-aggressive roots do not damage sidewalks or driveways
Acer truncatum Purpleblow maple	Sun	20-25 feet/ 20-25 ft. spread	5 feet	Prefers moist, well-drained soil, but drought tolerant; very cold hardy deciduous tree; moderate growth rate; yellow flowers in spring; an additional maple cultivar of interest is 'Pacific sunset'
Amelanchier x grandiflora 'Autumn Brilliance' Serviceberry	Sun/partial shade	20-25 feet/ To 15 ft. spread	4 feet +	Moist to dry, well-drained soils; shrub or small tree; drought tolerant; white clustered flowers in spring; red or yellow fall color; also try 'Princess Diana' for bright red fall color and the slightly taller 'Robin Hill' (20-30 feet)
Carpinus caroliniana American hornbeam	Sun/partial shade	20-30 feet/ 20-30 ft. spread	4-6 feet	Deciduous; prefers moist, rich soils; grows near saturated areas but is only weakly tolerant of saturation; blooms March-May; slow growing; deep coarse laterally spreading roots; medium life span; also consider Carpinus japonica (Japanese hornbeam)

A2 Small Trees

SMALL TREES (UNDER 30 FEET IN HEIGHT) SPACE EVENLY EVERY 20 TO 30 FEET				
SPECIES/ COMMON NAME	EXPOSURE	MATURE HT./ SPREAD	PLANTING STRIP WIDTH	COMMENTS
Cercis Canadensis Eastern redbud	Partial shade/ sun	25 feet/ 30 ft. spread	4 feet +	Deciduous; prefers moist, rich soils; tolerant of shade; somewhat drought resistant, but not in full sun; purple-lavender flowers; medium longevity; often multi-trunked; shallow, fibrous roots become deeper on drier sites; fairly short-lived; blooms March-May
Cornus kousa var. 'Chinensis' Chinese kousa dogwood	Sun/partial shade	To 20 feet/ To 20 ft. spread	3 feet +	Prefers moist soils; tolerant of varying soil types; moderate growth rate; deciduous; white flowers in June and large red fruits that resemble a raspberry in September; red to maroon fall color; more disease resistant than other dogwoods; many additional cultivars available
Crataegus x lavalii Lavalle hawthorn	Sun	To 25 feet/ 15-20 ft. spread	4-5 feet	Deciduous; prefers moist, well-drained soil, but tolerant of varying soil types; bronze and coppery red fall color; white flowers in spring; fruit can be a bit messy
Malus ssp. Flowering crabapple	Sun/partial shade	15-25 feet/ 6-15 ft. spread	4-5 feet	Tolerant of prolonged soil saturation; somewhat untidy; short lived; tolerant of drought and seasonally saturated soils; deciduous; white or faintly pink flowers in spring; numerous Malus species and cultivars provide a variety of foliage and flower colors, forms, and fruit. Many cultivars and varieties available including M. 'Adirondack' (to 10 ft. height), M. floribunda (Showy crab); M. 'Sugar Tyme' (to 18 ft. height); native M. fusca* (Pacific crabapple) reaches 30-40 ft in height
Parrotia persica Persian ironwood	Sun/light shade	15-35 feet/ 15-30 ft. spread	4 feet	Moist to dry soils; drought tolerant when established, deciduous tree with moderate growth rate; brilliant fall color; often multi-trunked, but can be trained to have just one; tolerates urban pollution and soil compaction; surface roots do not generally cause problems; virtually disease and pest-free

SMALL TREES (UNDER 30 FEET IN HEIGHT) SPACE EVENLY EVERY 20 TO 30 FEET				
SPECIES/ COMMON NAME	EXPOSURE	MATURE HT./ SPREAD	PLANTING STRIP WIDTH	COMMENTS
Prunus serrulata 'Shirofugen' Japanese flowering cherry	Sun	To 25 feet/ To 25 ft. spread	4 feet	Deciduous flowering tree; moist, well-drained soils; double pink to white blooms in spring; vigorous grower; additional desirable choices include P. serrulata 'Snowgoose', 'Kwanzan', and 'Shirotae'
Quercus ilex Holly oak	Sun/partial shade	20+ feet/ 20 ft. spread	5 feet +	Prefers moist soils, but grows in varying soils; hearty, slow-growing evergreen tree; light pink flowers May-June; pruning will keep tree small for a hedge, without pruning may grow considerably larger – not appropriate under utility lines; tolerates salt water spray

A2 Medium Trees



indicates a tree that does well in wet areas

* denotes native species

MEDIUM TREES (30-50 FEET IN HEIGHT) SPACE EVENLY EVERY 25 TO 35 FEET				
SPECIES/ COMMON NAME	EXPOSURE	MATURE HT./ SPREAD	PLANTING STRIP WIDTH	COMMENTS
Acer platanoides 'Columnare' Columnare Norway maple	Sun/partial shade	40-50 feet/ 15-20 ft. spread	5-6 feet	Deciduous; adapts to varying soils; upright or columnar in form making this cultivar a better choice for narrow locations; tolerant of drought and seasonal inundation; tolerates urban pollution and displays brilliant fall color; shallow rooting necessitates locating at least 4-6 feet from sidewalks and driveways to prevent heaving of pavement
Acer rubrum  Red maple	Sun/partial shade	35-50 feet/ 15-40 ft. spread	5-6 feet	Deciduous tree known for fall color; prefers wet or moist soils; tolerant of summer drought and urban pollutants; fast growing with roots that may heave sidewalks or interfere with mowing; many cultivars of varying heights available including: A. rubrum, 'Armstrong,' Bowhall', Karpick,' 'Scarsen,' and 'Red Sunset'
Carpinus betulus European hornbeam	Sun/shade	40-60 feet/ 30-40 ft. spread	5 feet	Deciduous tree; tolerant of urban pollution and poor soils; can also be used as a hedge or screen cultivars available and suggested include 'Fasigiata' (30-40 ft. height) and 'Franz Fontaine' (30-35 ft height)
Fraxinus americana 'Autumn Applause' Ash	Sun	To 40 feet/ 25 ft. spread	5-6 feet	Deciduous; prefers moist, well-drained soils; dense, wide spreading canopy; long-lived; purple fall color; moderate growth rate; also try F. Americana 'Junginger'

Medium Trees **A2**

MEDIUM TREES (30-50 FEET IN HEIGHT) SPACE EVENLY EVERY 25 TO 35 FEET				
SPECIES/ COMMON NAME	EXPOSURE	MATURE HT./ SPREAD	PLANTING STRIP WIDTH	COMMENTS
Fraxinus oxycarpa Raywood ash	Sun	25-50 feet/ 25 ft. spread	5 feet +	Deciduous; drought and variable soil tolerant; can take extreme temperatures; does not tolerate constant wind or fog; resists pests and disease better than do other ashes; inconspicuous flowers in spring
Fraxinus pennsylvanica Green ash/red ash	Sun	To 50 feet/ To 40 ft spread	4-5 feet +	Deciduous; prefers moist soils; fast growth rate; tolerant of wind, salt, seasonal drought and urban pollution; numerous cultivars including Patmore' (50-60 ft. height), 'Summit' (to 45 ft. height), and 'Urbanite' (to 50 ft. height)
Ginkgo biloba 'Autumn Gold' Maidenhair tree	Partial sun/ partial shade	25-50 feet/ 25-30 ft. spread	5-6 feet	Moist soils; deciduous ornamental tree; fast growing and long-lived; tolerant of urban pollution, summer drought and winter inundation; showy fall color; grows in soils of varying quality; provides dense canopy; additional cultivars available
Gleditsia triacanthos inermis 'Shademaster' Thornless honeylocust	Sun/partial shade	To 45 feet/ 35 ft. spread	5-6 feet	Deciduous; prefers moist, rich soils, but will grow in varying soil types; a thornless cultivar tolerant of drought and seasonal inundation; adapts to urban pollution and displays vigorous growth; deciduous tree with showy yellow fall color; additional cultivars available such as 'Imperial,' which grows 30-35 feet, 'Moraine,' and 'Rubylace'

A2 Medium Trees

MEDIUM TREES (30-50 FEET IN HEIGHT) SPACE EVENLY EVERY 25 TO 35 FEET				
SPECIES/ COMMON NAME	EXPOSURE	MATURE HT./ SPREAD	PLANTING STRIP WIDTH	COMMENTS
<i>Koelreuteria paniculata</i> Goldenrain tree	Sun/partial sun	20-35 feet/ 10-30 ft. spread	4 feet +	Deciduous; prefers moist well-drained soils, but is tolerant of poor soils; medium rate of growth and longevity; tolerant of periods of drought and seasonal inundation; tolerates urban pollution; provides a dense, wide-spreading canopy
<i>Platanus x acerifolia</i> 'Liberty' London planetree	Sun	To 50 feet/ 45 ft. spread	8 feet	Prefers moist, rich soils, but tolerant of a variety of soils; tolerant of seasonal drought and inundation, urban pollution and poor soils; deciduous tree resistant to sycamore anthracnose, powdery mildew, and inward spread of wood decay due to trunk wounds; patchy ornamental bark; pruning of lower branches may be required for visibility; shallow roots can cause uplifting of sidewalks and pavement – use care when locating near pavement; also try 'Bloodgood' and 'Yarwood'
<i>Pyrus calleryana</i> 'Chanticleer' Flowering pear	Sun	To 40 feet/ 15 ft. spread	4-5 feet	Deciduous tree that grows well in a variety of soil types; orange to reddish fall color; white flowers in spring; additional cultivars of interest include <i>P. calleryana</i> 'Redspire' and 'Aristocrat'

Medium Trees **A2**

MEDIUM TREES (30-50 FEET IN HEIGHT) SPACE EVENLY EVERY 25 TO 35 FEET				
SPECIES/ COMMON NAME	EXPOSURE	MATURE HT./ SPREAD	PLANTING STRIP WIDTH	COMMENTS
Tilia cordata Littleleaf linden	Sun	30-50 feet/ 30 ft. spread	5-6 feet	Deciduous; prefers moist, well-drained soils, but tolerant of a variety of soil types; tolerant of wind and urban pollution; fast growing and long-lived; tolerates summer drought and seasonal inundation; provides a dense canopy; C. cordata is the hardiest linden; many forms available including, T. cordata 'Chancellor', 'Corzam', and 'Greenspire'

A2 Large Trees

LARGE TREES (50 FEET+ IN HEIGHT) SPACE EVENLY EVERY 35 TO 45 FEET				
SPECIES/ COMMON NAME	EXPOSURE	MATURE HT./ SPREAD	PLANTING STRIP WIDTH	COMMENTS
Abies grandis* Grand Fir	Sun/partial shade	100 feet/ 40 ft. spread	Check with jurisdiction	Evergreen; tolerant of fluctuating water tables and floods; medium rate of growth; root structure depends on site conditions – shallow in moist areas, deep taproot in drier conditions
Acer platanoides 'Emerald Queen' Emerald Queen Norway maple	Sun/partial shade	To 50 feet/ 40 ft. spread	5-8 feet	Deciduous; fast growing with an erect, spreading form; prefers moist soils, but is tolerant of summer drought and seasonal inundation; tolerates urban pollution; avoid locating near structures due to shallow, vigorous rooting; additional cultivars available including A. platanoids 'Parkway'
Acer pseudoplatanus Sycamore maple	Sun/partial shade	40-60 feet/ 25-40 ft. spread	5-8 feet	Deciduous; prefers moist, well-drained soils but is adaptable to many soil types; tolerates summer drought and seasonal inundation; tolerant of urban pollution with a moderate growth rate; sturdy, resistant to wind and salt spray; a number of cultivars are available including: A. pseudoplatanus 'Atropurpureum,' 'Brilliantissimum,' 'Cox' (Lustre), and 'Puget Pink'
Acer saccharum Sugar maple	60-75 feet/ 35 ft. spread	6 feet +		Deciduous; prefers moderately moist, well-drained soils; long-lived and tolerant of urban pollutants; slow to medium growth rate; needs large planting area; yellow and orange fall color; a variety of cultivars available including A. saccharum 'Legacy'



LARGE TREES (50 FEET+ IN HEIGHT) SPACE EVENLY EVERY 35 TO 45 FEET				
SPECIES/ COMMON NAME	EXPOSURE	MATURE HT./ SPREAD	PLANTING STRIP WIDTH	COMMENTS
Calocedrus decurrens* Incense cedar	Sun/partial shade	75-90 feet/ 10-20 ft. spread	Check with jurisdiction	Evergreen; tolerant of poor soils; drought tolerant after established; tolerant of wind and urban conditions; narrow growth habit makes this a good choice for smaller spaces and ideal for screening; fragrant tree; slow growing and long-lived
Fraxinus latifolia* Oregon ash 	Sun/partial shade	40-80 feet/ 30 ft. spread	6 feet +	Deciduous; saturated, ponded or moist soils; flood tolerant; small green-white flowers; tolerant of poor soils
Gleditsia triacanthos inermis Thornless honeylocust	Sun/partial shade	60-70 feet/ 40 ft. spread	5-6 feet	Deciduous; prefers moist soils, but will grow in poor soils; tolerant of drought, seasonal inundation, and urban pollution; occasionally fruit pods can create litter during winter months; thornless; cultivars available (see G. triacanthos inermis 'Shademaster' below in Medium trees)
Metasequoia glyptostroboides Dawn redwood	Sun	70-100 feet/ 25 ft. spread	5 feet +	Deciduous; prefers moist, deep, well-drained soils, but tolerates compacted and poor soils; long-lived, fast growing conifer; tolerant of seasonal inundation and drought; can grow in standing water; needles turn russet in the fall; needs large growing area; lower growing cultivars available such as M. glyptostroboides 'Gold Rush' and 'Sheridan Spire'

A2 Large Trees

LARGE TREES (50 FEET+ IN HEIGHT) SPACE EVENLY EVERY 35 TO 45 FEET				
SPECIES/ COMMON NAME	EXPOSURE	MATURE HT./ SPREAD	PLANTING STRIP WIDTH	COMMENTS
Picea omorika Serbian spruce	Sun/partial shade	50-60 feet/ 20-25 ft. spread	Check with jurisdiction	Slow growing; tolerant of varying soils and urban pollution; moderately drought tolerant once established; elegant evergreen spruce, good for narrow locations; lower growing cultivars available
Quercus bicolor Swamp white oak	Sun	60 feet/ 45 ft. spread	6-8 feet	Deciduous; grows in wet or moist sites, but is tolerant of drought conditions; withstands poorly drained soils; long-lived with moderate rate of growth
Quercus coccinea Scarlet oak	Sun	50-60 feet/ 45 ft. spread	6-8 feet	Deciduous; grows in a variety of soil types; long-lived with a moderate growth rate; tolerant of summer drought and urban pollution; does not tolerate saturated soils or shade; brilliant scarlet to red fall foliage
Quercus macrocarpa Burr Oak	Sun	70-80 feet/ 30-40 ft. spread	8 feet	Prefers moist soils, but is adaptable to varying soils; slow growing and long-lived; rugged looking deciduous tree; tolerant of seasonal drought and inundation; tolerates urban pollution and city conditions; provides a wide-spreading, dense canopy
Quercus phellos Willow oak	Sun/partial shade	60-70 feet/ 50 ft. spread	6 feet	Deciduous; prefers moist, well-drained soils, but grows in a wide range of soils types; long-lived tree with moderate growth rate and fibrous root system; tolerant of seasonal drought and inundation, as well as urban pollution; provides a wide-spreading, dense canopy; small delicate leaves

LARGE TREES (50 FEET+ IN HEIGHT) SPACE EVENLY EVERY 35 TO 45 FEET				
SPECIES/ COMMON NAME	EXPOSURE	MATURE HT./ SPREAD	PLANTING STRIP WIDTH	COMMENTS
Quercus robur English oak	Sun	40-60+ feet/ 40 ft. spread	4-8 feet	Prefers well-drained soil; slow to moderate growth rate; long-lived deciduous tree; tolerant of seasonal drought and inundation; tolerates urban pollution, poor soils and constrained root space; susceptible to powdery mildew; many varieties and cultivars available including: 'Concordia,' 'Fastigiata,' 'Foliis Variegatis,' and 'Westminster Globe.'
Quercus rubra Northern red oak	Sun/partial shade	60-75 feet/ 50 ft. spread	6-8 feet	Prefers moist, well-drained soils, but drought tolerant when established; tolerates seasonal inundation, urban pollution and salt spray; moderate rate of growth and longevity; provides a dense, wide-spreading canopy; susceptible to oak wilt fungus
Quercus shumardii Shumard's oak	Sun	To 70 feet/ 50 ft. spread	8 feet	Prefers moist, well-drained soils; deciduous, long-lived tree; tolerant of seasonal drought and inundation, urban pollution and poor soils
Taxodium distichum Bald cypress	Sun/partial shade	To 75 feet/ 40 ft. spread	Check with jurisdiction	Deciduous conifer; wet, mucky soils; tolerant of summer drought and seasonal flooding; will grow in poor soils; slow growing; long-lived with a wide-spreading canopy; roots do not appear to lift sidewalks as readily as other species; prune lower branches for sight-lines; cultivars include T. distichum 'Shawnee Brave'

A2 Large Trees

LARGE TREES (50 FEET+ IN HEIGHT) SPACE EVENLY EVERY 35 TO 45 FEET				
SPECIES/ COMMON NAME	EXPOSURE	MATURE HT./ SPREAD	PLANTING STRIP WIDTH	COMMENTS
Thuja plicata* Western red cedar 	Partial shade/shade	200 + feet/ 60 ft. spread	Check with jurisdiction	Moist to swampy soils; evergreen tree tolerant of seasonal flooding and saturated soils; a good tree for screening; long-lived; cultivars 'Pumilio' and 'Cuprea' are shorter versions, 'Aurea' and 'Atrovirens' have distinctive foliage
Tilia platyphyllos Bigleaf linden 	60-80 feet/ 60 ft. spread	Check with jurisdiction	Check with jurisdiction	Prefers moist, well-drained soils, but grows in a variety of soil types; deciduous tree with medium growth rate; long-lived; tolerant of seasonal drought and inundation; tolerates urban pollutants; provides a wide-spreading, dense canopy; yellowish-white flowers attract bees
Ulmus ssp. Elm hybrids	Sun	50-60 feet/ 35-50 ft. spread	6-8 feet	Deciduous; prefers moist, well-drained soils, but drought tolerant; rapid grower; attractive yellow fall color; a hybrid elm resistant to Dutch elm disease; suggested hybrids include 'Accolade', 'Homestead' and 'Pioneer'
Umbellularia californica Oregon myrtle	Sun/partial shade	40-75+ feet/ To 50 ft. spread	Check with jurisdiction	Prefers moist, well-drained soils; slow growing evergreen tree with aromatic leaves; tolerates seasonal drought and inundation; tolerant of urban pollution; provides a wide-spreading, dense canopy; resistant to pests and disease; good for tall hedges or, when trunks are thinned, as a street tree; requires summer watering until established

SOURCES:

- Barborinas, J. (2004, August). *Street Tree Varieties for WSU*. Mount Vernon, WA: Urban Forestry Services, Inc.
- City of Beaverton. (2002). *Approved street tree list*. Beaverton, OR: Author. Retrieved September 2, 2004 from http://www.ci.beaverton.or.us/departments/operations/operations_street_trees.html
- City of Eugene. (n.d.) Appendix A: Approved street tree species list. *Appendix to Administrative Rule R-7.28 of Eugene City Code*. Eugene, OR: Author.
- City of Lynnwood. (n.d.) *Tree preservation and protection guidelines for the City of Lynnwood*. Lynnwood, WA: Author.
- City of Seattle. (2003, March). *Seattle street tree planting procedures (Publication Number 520)*. Seattle, WA: Seattle Transportation.
- City of Seattle Urban Forest Coalition. (1998). *A city among the trees: An urban forestry resource guide*. Seattle, WA: Author.
- Dirr, M.A. (1998). *Manual of woody landscape plants: Their identification, ornamental characteristics, culture, propagation and uses (Fifth ed.)*. Champaign, IL: Stipes Publishing, L.L.C.
- Fitzgerald, S.A., & Ries, P.D. (1997). *Selecting, planting, and caring for a new tree*. Corvallis, OR: Oregon State University Extension Service.
- Hightshoe, G.L. (1988). *Native trees, shrubs, and vines for urban and rural America*. New York, NY: Van Nostrand Reinhold.
- Hogan, E.L. (Ed.). (1990). *Sunset western garden book*. Menlo Park, CA: Lane Publishing Co.
- International Society of Arboriculture. (1995). *Avoiding tree and utility conflicts*. [Brochure]. Retrieved August, 17, 2004 from http://www.treesaregood.com/treecare/avoiding_conflicts.aspx
- Jacobson, A.L. (1989). *Trees of Seattle: The complete tree-finder's guide to the City's 740 varieties*. Seattle, WA: Sasquatch Books.
- Jacobson, A.L. (1996). *North American landscape trees*. Berkeley, CA: Ten Speed Press.
- Kruckeberg, A.R. (1982). *Gardening with native plants of the Pacific Northwest*. Seattle, WA: University of Washington Press.
- Leigh, M. (June 1999). *Grow your own native landscape: A guide to identifying, propagating & landscaping with Western Washington plants*. Native Plant Salvage Project, WSU Cooperative Extension – Thurston, County.
- Metro. (June 2002). *Trees for green streets: An illustrated guide*. Portland, OR: Author.

A2 Sources

- Phillips, L.E. (1993). *Urban trees: A guide for selection, maintenance, and master planning*. New York, NY: McGraw-Hill, Inc.
- Pojar, J. and MacKinnon, A. (1994). *Plants of the Pacific Northwest Coast: Washington, Oregon, British Columbia and Alaska*. Renton, WA: Lone Pine Publishing.
- Portland Bureau of Environmental Services. *Native plant selection guide*. Retrieved July 6, 2004 from <http://www.portlandonline.com/bes/index.cfm?&a=40732&c=31892>
- Seattle City Light. (1988). *The Right Tree Book*. Seattle, WA: Seattle City Light.
- Thompkins, Dennis. Certified Arborist/Forestry Consultant. Personal communication, August 2004.
- U.S. Department of Agriculture, Forest Service Fire Effects Website www.fs.fed.us/database/feis/plants/tree
- U.S. National Arboretum. (1999 November). *Platanus x acerifolia* 'Columbia' and 'Liberty.' *U.S. National Arboretum Plant Introduction*. U.S. Department of Agriculture. Floral and Nursery Plants Research Unit. Retrieved June 16, 2004 from <http://www.usna.usda.gov/Newintro/platanus.pdf>

3

Appendix Three *Laboratory Procedures for Determining Bioretention Soil Mix Saturated Hydraulic Conductivity*

The recommended permeability testing method for bioretention soil media is ASTM D2434 Standard Test Method for Permeability of Granular Soils. This test was developed for mineral aggregate material rather than soils that contain appreciable amounts of organics. Organic soils tend to swell when mixed with water and are sensitive to compaction, which can cause variability in test results. As a result, the City of Seattle identified a need for changes to the standard permeability testing procedures to provide more consistent and reliable results. Aspect Consulting, LLC was retained to conduct two workshops with local soil testing laboratories, have each of the laboratories conduct permeability testing, and develop recommendations for modifications to the standard permeability testing procedures that would provide more consistent results. The following are recommendations for revising the standard permeability testing procedures based on the workshops and laboratory testing.

Recommended Modifications for Permeability Testing of Bioretention Soils

Proctor method ASTM D1557 Method C (6-inch mold) shall be used to determine maximum dry density values for compaction of bioretention soil sample. Sample preparation for the Proctor test shall be amended in the following ways:

1. Maximum grain size within the sample shall be no more than ½ inch in size.
2. Snip larger organic particles (if present) into ½-inch long pieces.
3. When adding water to the sample during the Proctor test, allow the sample to pre-soak for at least 48 hours to allow the organics to fully saturate before compacting the sample. This pre-soak ensures the organics have been fully saturated at the time of the test.

ASTM D2434 shall be used and amended in the following ways:

4. Apparatus:
 - a. 6-inch mold size shall be used for the test.
 - b. If using porous stone disks for the testing, the permeability of the stone disk shall be measured before and after the soil tests to ensure clogging or decreased permeability has not occurred during testing.
 - c. Use the confined testing method, with 5- to 10-pound force spring.
 - d. Use de-aired water.
5. Sample:
 - a. Maximum grain size within the sample shall not be more than ½ inch in size.
 - b. Snip larger organic particles (if present) into ½-inch long pieces.
 - c. Pre-soak the sample for at least 48 hours prior to loading it into the mold. During the pre-soak, the moisture content shall be higher than optimum moisture but less than full saturation (i.e., there shall be no free water). This pre-soak ensures the organics have been fully saturated at the time of the test.

6. Preparation of Sample:
 - a. Place soil in cylinder via a scoop.
 - b. Place soil in 1-inch lifts and compact using a 2-inch diameter round tamper. Pre-weigh how much soil is necessary to fill 1-inch lift at 85 percent of maximum dry density, then tamp to 1-inch thickness. Once mold is full, verify that density is at 85 percent of maximum dry density (+ or – 0.5 percent). Apply vacuum (20 inches Hg) for 15 minutes before inundation.
 - c. Inundate sample slowly under a vacuum of 20 inches Hg over a period of 60-75 minutes.
 - d. Slowly remove vacuum (> 15 seconds).
 - e. Sample shall be soaked in the mold for 24-72 hours before starting test.

7. Procedure:
 - a. The permeability test shall be conducted over a range of hydraulic gradients between 0.1 and 2.
 - b. Steady state flow rates shall be documented for four consecutive measurements before increasing the head.
 - c. The permeability test shall be completed within one day (one-day test duration).

Appendix Four

Maintenance of Low Impact Development Facilities

4

The following provides two maintenance guidelines. The first is a general maintenance approach that includes goals, objectives, support strategies, and responsibilities. The second is a more detailed maintenance manual for bioretention and permeable pavement developed by the City of Seattle. The manual covers soils, plants, and hardscape infrastructure (e.g., catch basins and pipes) for bioretention, and inspection and maintenance for permeable pavement. Maintenance effort is based on levels of service acceptable for the location of the facilities and the jurisdiction. An additional maintenance manual, developed by the City of Bellevue, is available at: http://www.bellevuewa.gov/pdf/Utilities/Natural_Drainage_Practices.pdf.

A. Introduction

Maintenance of LID facilities is essential to ensure that designed stormwater management performance and other benefits continue over the full life cycle of the installation. Some maintenance agreements and activities associated with LID practices are similar to those performed for conventional stormwater systems; however, the scale, location, and the nature of an LID approach will also require new maintenance strategies. The following outlines typical maintenance goals and objectives, types of maintenance agreements, and training (WSU, AHBL, PSAT, 2007).

1. Goals and Objectives

Many maintenance goals of LID facilities will be similar throughout the Puget Sound region. The following provides a standard set of goals that can be added to or modified according to the specific physical settings and needs of a local jurisdiction.

A. Flow Control and Drainage

- Maintain designed infiltration capacity (reduce total volume of surface flows) and flow attenuation of facility (see Chapter 6 for guidelines on specific LID IMP's).
- Maintain designed detention capability to reduce peak flows (see Chapter 6 for guidelines on specific LID IMP's).
- Safely convey design storm flows.

B. Water Quality Treatment

- Maintain designed infiltration and detention capability (see Chapter 6 for guidelines on specific LID IMP's).
- Preserve soil and plant health and contact of storm flows with those plant soil systems.

- C. Safety and Emergency Vehicle Access
 - Maintain adequate sight distances.
 - Create signage for emergency vehicle access and facilities.
 - Ensure sufficient carrying capacity for emergency vehicles on any permeable load-bearing surfaces.
- D. Cost Effectiveness
 - Maintain facilities for long-term, high quality performance at a cost that is equal to, or less than, conventional systems.
 - Prevent expensive repair of large scale or catastrophic problems through continued routine procedures.
- E. Aesthetics
 - Develop LID facilities as a landscape amenity as well as a stormwater management system.
- F. Public Health
 - Minimize potential for disease transmission and mosquito breeding by maintaining designed infiltration capacity, storm flow conveyance, ponding depths, and dewatering rates.
- G. Community Participation
 - Provide educational materials to homeowners and commercial property owners explaining the benefits, function, and importance of community participation for the long-term performance of LID facilities.

2. Support Strategies

Effective measures to support and ensure quality maintenance of LID facilities include education, incentives, and regulations. In order to provide the most effective maintenance programs, a variety of strategies should be selected from the list below.

- A. Education
 - Simple, concise messages delivered throughout the project life cycle.
 - Brochures explaining the functions, benefits, and responsibilities of facilities at transfer of deed.
 - Information bulletins over public access channels.
 - Community volunteers providing informal workshops.
 - Ongoing involvement of developers with community groups.
 - Training programs for those maintaining the systems.
- B. Incentives
 - Reduce stormwater utility fees for individual homeowners or commercial properties.
 - Provide support for property owners with technical advice and materials, such as mulch and plants.
 - Provide awards and recognition to innovative developers and communities that build and properly maintain LID facilities.
- C. Regulations
 - Require maintenance plans and agreements prior to project approvals. These would include a list of all proposed facilities, facility locations, a schedule of maintenance procedures, monitoring requirements, if any, and an agreement that all subject properties are collectively liable for the ongoing maintenance of the facilities.
 - Mandate jurisdictional maintenance and additional taxes for funding.
 - Require fines for corrective actions.
 - State that maintenance responsibilities and liabilities are shared by all property owners for projects with facilities designed to serve multiple properties or owned and/or maintained collectively.
 - Require deed restrictions or covenants conveyed with deed for the full life cycle of all project types.

3. *Maintenance Responsibilities*

Low Impact Development facilities range in size and complexity. Accordingly, entities responsible for maintenance should be appropriately matched to the tasks required to ensure long-term performance. An individual homeowner may be able to reasonably maintain a rain garden, permeable driveway, or other small facility; however, larger facilities are often maintained through private parties, shared maintenance agreements, or the presiding jurisdiction. In addition, the use and ownership of properties can often help dictate the most appropriate means of facility maintenance. Below are some general guidelines for the three primary categories of maintenance responsibilities.

A. Property Owners

- Are usually responsible for small facilities located on an individual property.
- Require basic knowledge and understanding of how the system functions.
- Jurisdiction(s) can improve system function over time by offering basic training to property owners.
- Should know when to seek and where to find technical assistance and any additional information.
- Requirements for maintenance should be conveyed with deed.
- Failure to properly maintain LID facilities may result in jurisdictional liens.

B. Private Parties (e.g., landscape maintenance companies)

- Handle the widest range of LID projects in size and scope.
- Handle most commercial or multi-family properties. Copies of agreement may be required prior to project approval.
- Unique maintenance agreements should be developed based on the scale, use, and characteristics of the site and conservation areas as well as level of expertise of the property owner and the responsible jurisdiction.
- Maintenance agreements can be between a variety of parties, such as individual homeowners, property owner associations, or even jurisdictions.
- Outside groups responsible for maintenance should be trained in the design, function, benefits, and maintenance of LID facilities.
- Recognize that LID integrated management practices require more frequent inspection than conventional facilities.
- Third-party maintainers should provide documentation to the property owners of the type of maintenance performed, a certificate of function, and any non-routine maintenance needs requiring specialized corrective actions. Third-party maintainers or property owners may be required to submit inspection results to the local jurisdiction.
- Jurisdictions may choose to provide an educational course for prospective maintenance parties and a list of approved or recommended parties.

C. Jurisdictions

- Will handle most public LID infrastructure.
- Should be prepared to handle non-routine maintenance issues for a variety of facilities. Non-routine maintenance may include, but is not limited to: replacing sections of permeable pavement, cleaning clogged permeable pavement, cleaning under-drains, and replacing or repairing surface infrastructure, such as pre-settling forebays, access grates, and monitoring structures.
- Maintain primarily large facilities, except for those requiring corrective action.
- Private LID facilities requiring corrective action may require a jurisdiction to hire a private party or use their own staff to complete the work. Property owners should be billed for these expenses.

4. *Inspections*

Regular and appropriately timed inspections are necessary for the proper operation of LID facilities over the full life cycle of the installation. Inspectors should be trained in the design and proper function and appearance of LID practices. Inspections should be seasonally timed in order to achieve early detection, repair, and effective use of staff time. These inspections should include the following:

- During Fall to clear debris and organic material from structures and prepare for impending storms.
- Early winter storm events to confirm proper flow control operation and to identify any erosion problems.
- Before major horticultural cycles (i.e., prior to weed varieties dispersing seeds).
- Any other regularly scheduled maintenance activities.

To ensure continuity and to better identify trends in the function of facilities, the same individual(s) should inspect the same drainage area. Finally, LID facilities are integrated into the development landscape and willing homeowners can provide frequent inspection and identification of basic problems with minimal training.

Green Stormwater Operations and Maintenance Manual



Seattle Public Utilities

August 2009

Table of Contents

I. Overview.....	3
II. How to Use This Manual.....	3
III. GSI Contacts.....	3

List of Tables

Table I. Landscape and Vegetation Manual.....	4
Table II. System Functionality.....	7
Table III. Hardscape Manual.....	11
Table IV. Porous Pavement Manual.....	16
Table V. Other Elements.....	19
Table VI. Infiltration.....	22
Table VII. Safety, Spill Prevention and Response, and Pest Control.....	23

I. Overview

This manual is a summary of *routine* maintenance activities for the design of Natural Drainage System (NDS) Projects. Several *non-routine* maintenance activities are also included within this chart. The manual is divided into four service levels for the vegetation section and three service levels for the hardscape and Infrastructure section. For some design elements, the service levels are very similar.

This chart is intended to be a Maintenance Manual for scheduling and performing maintenance activities. The manual features images and descriptions for vegetation, hardscape, infrastructure, and infiltration rates. It includes NDS sites used currently in Seattle and several images from NDS projects in other municipalities. It is important to realize that *no single project includes every design element*. (That is, all the NDS portrayed in this chart will *NOT* be found within a given NDS project.) Maintenance crew coordinators need to use the relevant maintenance categories for a given project per the NDS Service Agreement.

II. How to Use This Manual





The successful use of this manual hinges on the inspection of project features, which in turn triggers the appropriate maintenance activities. To use this chart first select the desired Service Level for maintenance on an existing NDS project, then maintenance crews will inspect the system for the conditions listed in the left-hand column of the chart. Note that the desired service level may vary from project to project, based on the NDS goals, the project location, the project age (i.e. whether or not the plants have successfully established), and economic considerations. The descriptions and images for each service level may be used to help determine by visual inspection whether recommended maintenance activities, in the right-hand column, will need to be performed.









III. Contacts

Name	Phone Number	Title
Drena Donofrio	206-571-1566	GSI O&M Asset Manager
Deb Heiden	206-386-1802	Urban Ecosystems Asset Manager
Tracy Tackett	206-386-0052	GSI Program Manager

Table I. Landscape and Vegetation Manual

Service Category	Service Level A (Excellent Effort)	Service Level B (Good Effort)	Service Level C (Moderate Effort)	Service D (Poor Effort)
<p>Aesthetics (vegetation and trash)</p>	<ul style="list-style-type: none"> • Vegetation <ul style="list-style-type: none"> • Healthy and attractive • No bare spots • Plant palette is working for facility • At least 95% survival of establishing plants • Weeds - Little or no weeds are present • Asthetics <ul style="list-style-type: none"> • Clean, distinct edges • Vegetation confined to planted areas • No overgrown appearance/dead growth • Mulch <ul style="list-style-type: none"> • Evenly distributed & approximately 4" of arborist woodchip mulch. No evidence of erosion (stabilized surfaces) • Limited shoulder compaction • Homeowner is fully maintaining (where applicable) 	<ul style="list-style-type: none"> • Vegetation <ul style="list-style-type: none"> • Healthy with a good appearance • Occasional bare spots • Plant palette is mostly working for facility (At least 75%) • Weeds - Small quantities of weeds are present • Asthetics <ul style="list-style-type: none"> • Loose edges: grass/mulch encroaching on swale or vice versa • Some vegetation overlapping into pedestrian areas • Overgrown in isolated areas with some dead material • Mulch <ul style="list-style-type: none"> • 2"-4" layer of mulch is present • Erosion likely unless maintenance improved • Some shoulder compaction • Homeowner is providing some maintenance (where applicable) • Able to achieve Level A without complete retrofit 	<ul style="list-style-type: none"> • Vegetation <ul style="list-style-type: none"> • Poor vegetation health and appearance • Bare spots are frequent • Plant palette is not working for facility (75%-50%) • Weeds - Weeds common • Asthetics <ul style="list-style-type: none"> • No edges; • Surrounding vegetation spills into swale and pedestrian areas • Mulch <ul style="list-style-type: none"> • Mulch is less than 2" • Substantial eroded areas • Shoulder compaction • Homeowner is not maintaining swale (where applicable) • Unable to achieve higher service levels without complete retrofit 	<ul style="list-style-type: none"> • Vegetation <ul style="list-style-type: none"> • Poor Planted vegetation health and appearance • Bare spots are common • Plant palette has failed Less than 50% • Weeds - Weeds dominant • Asthetics <ul style="list-style-type: none"> • No edges; surrounding vegetation spills into swale or vice versa • Mulch <ul style="list-style-type: none"> • Mulch is absent • Substantial eroded areas • Shoulder compaction • Homeowner is not maintaining swale (where applicable) • Unable to achieve higher service levels without complete retrofit

Service Category	Service Level A (Excellent Effort)	Service Level B (Good Effort)	Service Level C (Moderate Effort)	Service D (Poor Effort)
Special Considerations for Noxious Weeds	Zero tolerance of Class A, B, C and non-designated noxious weeds	Zero tolerance of Class A and B. Class C weeds are controlled or absent. Non-designated weeds are controlled or absent.	Zero tolerance of Class A weeds. Class B and C are controlled. Non-designated are present (Control Prog. Is minimal)	Zero tolerance of Class A weeds. Class B, C, and Non-Designated are largely uncontrolled except for public safety reasons (illegal dumping, obstructs vision)
Link to King County Noxious Weed List				
Vegetation	Lush vegetation; excellent appearance 	Mostly healthy vegetation with good appearance 	Mostly healthy vegetation with neglected appearance 	Poorly planted vegetation health and neglected appearance 

Service Category	Service Level A (Excellent Effort)	Service Level B (Good Effort)	Service Level C (Moderate Effort)	Service D (Poor Effort)
Aesthetics	<p>Healthy, well-maintained vegetation; excellent appearance</p> 	<p>Appearance is good</p> 	<p>Moderate appearance</p> 	<p>Poorly maintained appearance</p> 
Mulch	<p>Deep mulch layer(4"-6"), clean edges, limited compaction</p> 	<p>Some mulch(2"-4"), loose edges, some compaction</p> 	<p>Little mulch(Less than 2"), no defined edge, shoulder compaction</p> 	<p>No mulch present, no defined edge, shoulder compaction</p> 













Service Category	Service Level A (Excellent Effort)	Service Level B (Good Effort)	Service Level C (Moderate Effort)	Service D (Poor Effort)
Weeds	<p>No weedy species present</p> 	<p>Occasional weedy species (5-10%)</p> 	<p>Lots of Weedy species (10-20%)</p> 	<p>Weedy species predominant (More than 20%)</p> 
Erosion and bare spots	<p>No erosion or bare spots</p> 	<p>Some erosion and bare spots (0-5%)</p> 	<p>Substantial erosion and bare spots (5-10%)</p> 	<p>Completely eroded and bare spots (More than 10%)</p> 

Table II. System Functionality

Service Category	Service Level A (Excellent Effort)	Service Level B (Good Effort)	Service Level C (Moderate Effort)	Service Level D (Poor Effort)
SYSTEM FUNCTIONALITY				
Bioretention (vegetation & soils/substrate)	<ul style="list-style-type: none"> • Vegetation <ul style="list-style-type: none"> • 100% of swale bottom is covered with healthy, wetland vegetation • No bare spots • Infiltration <ul style="list-style-type: none"> • Soil is well aerated, no evidence of compaction • Water drains within 48 hours • Maintenance <ul style="list-style-type: none"> • No erosion, channelization or scouring • No significant sediment or debris accumulation 	<ul style="list-style-type: none"> • Vegetation <ul style="list-style-type: none"> • At least 80% of swale bottom is covered with healthy, wetland vegetation • Minimal bare spots 10% • Infiltration <ul style="list-style-type: none"> • Some evidence of compaction (2" of mulch) • Most water drains within 24 hours, minimal long-term ponding • Maintenance <ul style="list-style-type: none"> • Some erosion, channelization or scouring • Sediment or debris accumulation does not affect the function of the facility. 	<ul style="list-style-type: none"> • Vegetation <ul style="list-style-type: none"> • Between 60-80% of swale bottom is covered with healthy, wetland vegetation • A few bare spots 10-20% • Infiltration <ul style="list-style-type: none"> • Compacted soils (Lack of Mulch) • The presence of long-term ponding (> 72 hours) • Maintenance <ul style="list-style-type: none"> • Erosion, channelization or scouring • Sediment and debris accumulations inhibit the water quality function of the facility without affecting conveyance 	<ul style="list-style-type: none"> • Vegetation <ul style="list-style-type: none"> • Less than 60% of swale bottom is covered with healthy, wetland vegetation • Many bare spots • Infiltration <ul style="list-style-type: none"> • Compacted soils (Lack of Mulch) • The presence of long-term ponding (> 72 hours) • Maintenance <ul style="list-style-type: none"> • Erosion, channelization or scouring • Sediment and debris accumulations inhibit the water quality and conveyance of the system
Biofiltration (vegetation & soils/substrate)	<ul style="list-style-type: none"> • Vegetation <ul style="list-style-type: none"> • At least 80% of swale bottom covered with healthy, uniformed fine-stemmed vegetation at least 18 - 24 inches high • No bare spots • Maintenance <ul style="list-style-type: none"> • No erosion, channelization or scouring • No ponding • No significant sediment or debris accumulation 	<ul style="list-style-type: none"> • Vegetation <ul style="list-style-type: none"> • Between 60-80% of swale bottom covered with healthy, uniformed fine-stemmed vegetation at least 18 - 24 inches high • A few bare spots 10% • Maintenance <ul style="list-style-type: none"> • Some erosion, channelization or scouring • No ponding • Sediment and debris does not affect the function of the facility. 	<ul style="list-style-type: none"> • Vegetation <ul style="list-style-type: none"> • Between 60-40% of swale bottom covered with healthy, uniformed fine-stemmed vegetation, of at least 18 -24 inches high • Many bare spots 10-30% • Maintenance <ul style="list-style-type: none"> • Erosion, channelization or scouring • The presence of ponding • Sediment and debris affect the water quality function of the facility with out affecting conveyance. 	<ul style="list-style-type: none"> • Vegetation <ul style="list-style-type: none"> • Less than 40% of swale bottom covered with healthy, uniformed fine-stemmed vegetation, of at least 18 -24 inches high • Many bare spots • Maintenance <ul style="list-style-type: none"> • Erosion, channelization or scouring • The presence of ponding • Sediment and debris accumulations inhibit the water quality and conveyance of the system

Service Category	Service Level A (Excellent Effort)	Service Level B (Good Effort)	Service Level C (Moderate Effort)	Service Level D (Poor Effort)
Bioretention + biofiltration (vegetation & soils/substrate)	<ul style="list-style-type: none"> • At least 100% of swale bottom is covered with healthy, uniformed fine-stemmed wetland vegetation at least 18 - 24 inches high • Soil is well aerated, no evidence of vehicle compaction • No erosion, channelization or scouring • Water drains within 24 hours • No visible bare spots • Acceptable level of sediment or debris accumulation 	<ul style="list-style-type: none"> • 80% of swale bottom is covered with healthy, uniformed fine-stemmed wetland vegetation at least 18 - 24 inches high • Some evidence of vehicle compaction (lack of mulch) • Some erosion, channelization or scouring • Most water drains within 24 hours, minimal long-term ponding • A few bare spots 10-20% • Acceptable level of sediment or debris accumulation 	<ul style="list-style-type: none"> • Less than 80-50% of swale bottom is covered with healthy, uniformed fine-stemmed wetland vegetation at least 18 - 24 inches high • Compacted soils • Erosion, channelization or scouring • The presence of long-term ponding (> 72 hours) • Many bare spots • Significant build up of sediment or debris 	<ul style="list-style-type: none"> • Less than 50% of swale bottom is covered with healthy, uniformed fine-stemmed wetland vegetation at least 18 - 24 inches high • Compacted soils • Erosion, channelization or scouring • The presence of long-term ponding (> 72 hours) • Many bare spots or noxious weeds/grass • Significant build up of sediment or debris
Swale bottom vegetation				

























Service Category	Service Level A (Excellent Effort)	Service Level B (Good Effort)	Service Level C (Moderate Effort)	Service Level D (Poor Effort)
Sediment or debris accumulation				
Conveyance (vegetation & soils/substrate)	<ul style="list-style-type: none"> • Healthy vegetation • No erosion, channelization or scouring • No bare spots • No build up of sediment or debris • No non-designed obstructions to flow 	<ul style="list-style-type: none"> • Mostly healthy vegetation • Some erosion, channelization or scouring • Minimal bare spots 10-20% • Some build up of sediment or debris • Minimal non-designed obstructions to flow (over-grown vegetation, trash rack blockages) 	<ul style="list-style-type: none"> • Some vegetation • Erosion, channelization or scouring • Many bare spots 20-40% • Significant build up of sediment or debris • Significant non-designed obstructions to flow (over-grown vegetation, trash rack blockage) 	<ul style="list-style-type: none"> • Poor or no vegetation • Erosion, channelization or scouring • Many bare spots 40% or more • Significant build up of sediment or debris • Significant non-designed obstructions to flow (over-grown vegetation, trash rack blockage)

Table III. Hardscape Manual

Service Category	Service Level B (Good Effort)	Service Level C (Moderate Effort)	Service Level D (Low Effort)	Recommended Maintenance Activities
HARDSCAPE & INFRA-STRUCTURE	<p style="text-align: center;">Summary</p> <ul style="list-style-type: none"> • sediment is minimal • infrastructure is always accessible • no competition between roots(/dense plant material?) and pipes • no trash is present • small accumulation of organic debris on grates or screens • limited buildup of sediment behind check dams or log weirs • no erosion or undercutting surrounding weir walls • rockery and walls are stable and secure • stormwater sedimentation structures less than ½ full (NPDES) 	<p style="text-align: center;">Summary</p> <ul style="list-style-type: none"> • some sediment is present • infrastructure is usually accessible • some competition between roots(/dense plant material?) and pipes • small amounts of trash are present • moderate accumulation of organic debris on grates or screens • occasional large sediment deposits behind check dams or log weirs • minimal erosion and/or undercutting surrounding weir walls • occasional loose rocks; walls are secure • stormwater sedimentation structures less than ½ full (NPDES) 	<p style="text-align: center;">Summary</p> <ul style="list-style-type: none"> • Lots of sediment buildup is observed • infrastructure is mostly inaccessible • Significant competition between roots(/dense plant material?) and pipes • Trash is present • Heavy accumulations of organic debris on grates or screens • frequent large sediment deposits behind check dams or log weirs • Erosion and/or undercutting surrounding weir walls • Loose rocks; walls are not secure • stormwater sedimentation structures less than ½ full (NPDES) 	
Sedimentation structures— TYPE 2	Sediment is blocking 10% of structure 	Sediment is blocking 30% of structure 	Sediment is blocking 50% of structure 	<input type="checkbox"/> if sediment present, remove trash and unwanted organic debris <input type="checkbox"/> muck out / vacator structure and dispose of waste properly

Service Category	Service Level B (Good Effort)	Service Level C (Moderate Effort)	Service Level D (Low Effort)	Recommended Maintenance Activities
Grates and debris screens on catch basins (CBs)	Accumulation of organic debris covers 10% of structure 	Accumulation of organic debris covers 30% of structure 	Accumulation of organic debris covers 50% of structure 	<input type="checkbox"/> if present, muck out / vector catch basins and dispose of waste properly. Clear debris and vegetation growth around intakes.
<input type="checkbox"/> Outlet structures— TYPE 2	Accumulation of organic debris covers 10% of structure 	Accumulation of organic debris covers 30% of structure 	Accumulation of organic debris covers 50% of structure 	<input type="checkbox"/> remove debris and dispose of waste properly

Service Category	Service Level B (Good Effort)	Service Level C (Moderate Effort)	Service Level D (Low Effort)	Recommended Maintenance Activities
Flow control structures and overflow structures or pipes	Accumulation of organic debris covers 10% of structure 	Accumulation of organic debris covers 30% of structure 	Accumulation of organic debris covers 50% of structure 	Remove debris and vegetation growth and dispose of waste properly
<input type="checkbox"/> Log weirs and check dams	Sediment deposit of check dams or log weirs is about 10% 	Sediment deposits of check dams or log weirs is about 30% 	Sediment deposits of check dams or log weirs is about 50% or more 	<input type="checkbox"/> add splash-pool (rocks) to reduce scouring of swale-bottom for undercutting or eroding <input type="checkbox"/> remove sediment, debris, and trash if ponding upstream of check-dam

Service Category	Service Level B (Good Effort)	Service Level C (Moderate Effort)	Service Level D (Low Effort)	Recommended Maintenance Activities
Weir walls w/ flow control notch	Sediment deposit downstream of check dams or log weirs is about 10% 	Sediment deposit downstream of check dams or log weirs is about 30% 	Sediment deposit downstream of check dams or log weirs is about 50% or more 	<ul style="list-style-type: none"> add rocks to splash-pool to prevent scouring reinforce weir wall (<i>non-routine</i>) if leakage occurs at structure edges
Rockery / boulders PHOTOS TO BE UPDATED (shown here with little vegetative cover, but rocks may become covered in plant growth in well-established projects)	10% of rocks or walls are unsecured 	30% of rocks or walls are unsecured 	50% of rocks or walls are unsecured 	<ul style="list-style-type: none"> <input type="checkbox"/> ensure large rocks and boulders are stable













Service Category	Service Level B (Good Effort)	Service Level C (Moderate Effort)	Service Level D (Low Effort)	Recommended Maintenance Activities
Manufactured block sidewalls	<p>10% of rocks or walls are unsecured</p> 	<p>30% of rocks or walls are unsecured</p> 	<p>50% of rocks or walls are unsecured</p> 	<p>ensure blocks and bricks are stable</p>
Soil-wrap walls ("green walls")	<p>Erosion or undercutting of 10% is walls visible around rockery, walls and weirs</p> 	<p>Erosion or undercutting of 30% is visible around rockery, walls and weirs</p> 	<p>Erosion or undercutting of 50% is walls visible around rockery, walls and weirs</p> 	<p>□ repair as needed stabilize loose soil-bricks, notify vegetation crew if weeds present, water needed, or re-planting required</p>



Table IV. Porous Pavement Manual







Level of Service	Service Level B (Good Effort)	Service Level C (Moderate Effort)	Service Level D (Low Effort)	Recommended Maintenance Activities
Street	Infiltration rate of 20 +in/hr	Infiltration rate of 10 in/hr	Infiltration rate of 3 in/hr	based on peak flows for 100yr design storm 3 in/hr and excess capacity for localized failure
Sidewalk	Infiltration rate of 20 +in/hr	Infiltration rate of 10 in/hr	Infiltration rate of 1 in/hr	
				Test infiltration rates per SPU Materials Lab procedure.
	Pressure wash @2500 psi bi-annually	Pressure wash @ 2500 psi annually	Pressure wash @ 2500 psi annually	
				Pressure wash pavement with an industrial machine

Level of Service	Service Level B (Good Effort)	Service Level C (Moderate Effort)	Service Level D (Low Effort)	Recommended Maintenance Activities
	Remove 100% of Garbage	Remove 75% of Garbage	Remove 20% of Garbage	
				Remove all garbage and debris as required with wire brush, broom, or pressure washer. Dispose of debris and garbage off site.
	Remove 100% vegetation growth (moss/creeping plants) adjacent to pavement	Remove 75% vegetation growth (moss/creeping plants) adjacent to pavement	Remove 40% vegetation growth (moss/creeping plants) adjacent to pavement	
				Vegetated, landscaped, eroded, or soiled areas need to be maintained to prevent growth on to porous pavement, debris clogging, and lateral transport of adjacent materials. Keep joints free of material mechanically, with a weed burner, or pressure washer.

Level of Service	Service Level B (Good Effort)	Service Level C (Moderate Effort)	Service Level D (Low Effort)	Recommended Maintenance Activities
Infiltration Failure	Any evidence ponding water needs to be reported to USM Green Stormwater Infrastructure O&M Asset Manager for monitoring and restoration. Contact: Drena Donofrio at 206-571-1566			
Misc.	Inspect pavement for spalling, cracking edges, pot holes, depressions, large cracks, skid resistance, and raveling concrete 2X per year.	Inspect pavement for spalling, cracking edges, pot holes, depressions, large cracks, skid resistance, and raveling concrete 1X per year.	Inspect pavement for spalling, cracking edges, pot holes, depressions, large cracks, skid resistance, and raveling concrete every other year.	<i>SPU Materials lab (to quantify variability in field testing)</i>
	Pavement condition survey every 2 years	Pavement condition survey every 3 years	Pavement condition survey every 7 years	SDOT - contact Ben Hansen or current manager
	Address all safety issue to SDOT			Contact 684-ROAD for repair.

Table V. Other Elements

Service Category	Service Level B (Good Effort)	Service Level C (Moderate Effort)	Service Level D (Low Effort)	Recommended Maintenance Activities
OTHER ELEMENTS	<ul style="list-style-type: none"> • up to 10% blockage caused by organic matter, sediment, debris or trash • irrigation system functions properly with no blockages or breaks in drip system • ponding only to intended depth (varies by location) • pond capacity is maintained • no liner leakages reported 	<ul style="list-style-type: none"> • between 10-30% blockage caused by organic matter, sediment, debris or trash • irrigation system functions properly with no blockages or breaks in drip system • ponding only to intended depth (varies by location) • some sediment may reduce pond capacity • no liner leakages reported 	<ul style="list-style-type: none"> • more than 30% blockage caused by organic matter, sediment, debris or trash • irrigation system has occasional blockages or breaks in drip lines • ponding only to intended depth (varies by location) • sediment buildup causes reduced pond capacity • no leakages reported 	
<input type="checkbox"/> Curb cuts	<p>Curb is up to 10% blocked</p> 	<p>Curb is between 10-40% blocked</p> 	<p>Curb is above 40% blocked</p> 	<input type="checkbox"/> remove trash and organic debris and dispose properly

Service Category	Service Level B (Good Effort)	Service Level C (Moderate Effort)	Service Level D (Low Effort)	Recommended Maintenance Activities
Culverts	<p>Culvert is up to 10% blocked</p> 	<p>Culvert is between 10-40% blocked</p> 	<p>Culvert is more than 40% blocked</p> 	<p>remove trash and organic debris and dispose properly</p>
<p>□ Irrigation systems (for establishing vegetation)</p>	<p>holes in drip irrigation correspond with plant locations; nozzles have no breaks, leaks, or blocks</p> 	<p>plants and drip holes mostly aligned minimal seeping of water when system is off; no breaks or blockages</p> 	<p>system has breaks or leaks; vegetation is not being adequately watered; complaints of ponding</p> 	<p>repair as needed (for establishing vegetation 0-3 years old)</p>







Service Category	Service Level B (Good Effort)	Service Level C (Moderate Effort)	Service Level D (Low Effort)	Recommended Maintenance Activities
Porous/pervious pavers	<p>water infiltrates well, pavers are up to 10% clogged or minimal ponding is observed</p> 	<p>water infiltrates well, pavers are between 10-40% clogged and minimal ponding is observed</p> 	<p>water does not infiltrate well, pavers are more than 40% clogged</p> 	<p>vactor debris, weed burn as required</p>

Table VI. Infiltration

Infiltration Failure	Any evidence of a cell holding water for more than 24 hours needs to be reported to USM Green Stormwater Operations and Maintenance Asset Manager for monitoring or retrofitting. Contact: Drena Donofrio at 206-571-1566
-----------------------------	--

Table VII. Safety, Spill Prevention and Response, and Pest Control

Service Category	Service Level A (Excellent Effort)	Service Level B (Good Effort)	Service Level C (Moderate Effort)	Service Level D (Low Effort)
SAFETY, MOBILITY, ACCESS	<ul style="list-style-type: none"> • Vegetation causes no visibility (line of sight) or driver safety issues • Infrastructure is always accessible and has clear access path • Vegetation around infrastructure is maintained at height to prevent damage during routine maintenance • Fire hydrant access clearly visible and accessible • Vegetation does not impede pedestrian access 	<ul style="list-style-type: none"> • Vegetation causes minimal visibility (line of sight) or driver safety issues • Infrastructure is mostly accessible and has access path • Most vegetation around infrastructure is maintained at height to prevent damage during routine maintenance • Fire hydrant access clearly visible and accessible • Vegetation does not impede pedestrian access 	<ul style="list-style-type: none"> • Vegetation causes visibility (line of sight) or driver safety issues • Infrastructure is not accessible and has clear access path • Vegetation around infrastructure is will be damaged during routine maintenance • Fire hydrant access clearly visible and accessible • Vegetation does not impede pedestrian access 	<ul style="list-style-type: none"> • Vegetation causes visibility (line of sight) or driver safety issues • Infrastructure is not accessible and has clear access path • Vegetation around infrastructure is will be damaged during routine maintenance • Fire hydrant access clearly visible and accessible • Vegetation does not impede pedestrian access
				
SPILL PREVENTION	<ul style="list-style-type: none"> • Exercise spill prevention measures whenever handling or storing potential contaminants. • Fertilizers, Herbicides, Fungicides and Insecticides are prohibited in GSI. 			

SPILL RESPONSE	<ul style="list-style-type: none">• Clean up spills as soon as possible to prevent contamination of stormwater.
PEST CONTROL	<p>Insects:</p> <ul style="list-style-type: none">• Standing water remains in the basin for time periods suitable to insect development.• Identify the cause of the standing water and take appropriate actions to address the problem. <p>Rodents:</p> <ul style="list-style-type: none">• Rodent holes are present near the facility.• Fill and compact soil around the holes.



Seattle Public Utilities
Seattle Municipal Tower
700 Fifth Avenue
Suite 4900
PO Box 34018
Seattle, WA 98124-4018

©2011 Seattle Public Utilities

References

- Adams, M.C. (2003, May/June). Porous asphalt pavement with recharge beds: 20 years and still working [Electronic version]. *Stormwater*, 4(2).
- AHBL Civil & Structural Engineers/Planners. (2002, February 6). *WWHM comparison analysis project memo*. Tacoma, WA: Author.
- AHBL Civil & Structural Engineers/Planners. (2004, February). *Stormwater technical information report: Meadow on the Hylebos*. Tacoma, WA: Author.
- Allen, S.M. (1994). *Growth study of yardwaste compost, a demonstration garden at the Center for Urban Horticulture*. Master's thesis, University of Washington, Seattle.
- American Association of State Highway and Transportation Officials (2001). *A Policy on Geometric Design of Highways and Streets*. Washington, DC.: AASHTO.
- American Concrete Institute (2010). *522R-10 Report on Pervious Concrete*. Farmington Hills, MI.
- American National Standard Institute (ANSI). (2010). *External Fire Design Standard for Vegetative Roofs*. http://www.spri.org/pdf/ansi_spri_vf-1_external_fire_design_standard_for_vegetative_roofs_jan_2010.pdf
- American National Standard Institute (ANSI). (2010). *Wind Design Standard for Vegetative Roofing Systems*. [http://www.greenroofs.org/resources/ANSI SPRI RP 14 2010 Wind Design Standard for Vegetative Roofing Systems.pdf](http://www.greenroofs.org/resources/ANSI_SPRI_RP_14_2010_Wind_Design_Standard_for_Vegetative_Roofing_Systems.pdf)
- American Society of Landscape Architects (ASLA) (2010). *The Great Soil Debate Part II: Structural Soils Under Pavement*. Annual Meeting, September 11, 2010.
- Arendt, R.G. (1996). *Conservation design for subdivisions: A practical guide to creating open space networks*. Washington, D.C.: Island Press.
- Asadian, Y., Weiler M. (2009). A new approach in measuring rainfall interception by urban trees in coastal British Columbia. *Water Qual. Res. J. Can.* 44(1), 16-25.
- Attarian, J. (2010). Greener Alleys. *FWHA Public Roads Journal*, 73 (6). <http://www.fhwa.dot.gov/publications/publicroads/10mayjun/05.cfm>
- Avolio, C.M. (2003). *The local impacts of road crossings on Puget Lowland creeks*. Master's thesis, University of Washington, Seattle.
- Azous, L., & Horner, R.R. (Eds.). (2001). *Wetlands and urbanization: Implications for the future*. Boca Raton, FL: Lewis Publishers.
- Backstrom, M. (2000). Ground Temperature in Porous Pavement during Freezing and Thawing. *Journal of Transportation Engineering*, Vol. 126(5), 375-381.
- Bailey, C. (2003). *Low impact development: Barriers towards sustainable stormwater management practices in the Puget Sound region*. Master's thesis, Olympia, WA: The Evergreen State College.
- Balades, J.D., Legret, M., & Madiec, H. (1995). Permeable pavements: Pollution management tools. *Water Science and Technology*, 32, 49-56.

- Balousek, J.D. (2003). *Quantifying decreases in stormwater runoff from deep tilling, chisel plowing, and compost-amendment*. Dane County Conservation Department.
- Banks, M.K., Fiorenza, S., Oubre, C.L., & Ward, C.H. (2000). *Phytoremediation of hydrocarbon-contaminated soil*. Boca Raton, FL: Lewis Publishers.
- Bannerman, R.T., Owens, D.W., Dodds, R.B., & Hornewer, N.J. (1993). Sources of pollutants in Wisconsin stormwater. *Water Science Technology*, 28, 241-259.
- Barnes, Bob. Olympic Region Landscape Architect. Washington State Department of Transportation, Olympia. Personal communication, August 25, 2004.
- Bartens, J., Day, S., Harris, R., Wynn, T., and Dove, J. (2009). Transpiration and Root Development of Urban Trees in Structural Soil Stormwater Reservoirs. *Environmental Management* 44, 646-657.
- Bassuk, N., Grabosky, J., and Trowbridge, P. (2005). *Using CU-Structural Soil™ in the Urban Environment*. Cornell University, Ithica, NY.
- Bauer, H.H. & Mastin, M.C. (1997). *Recharge from precipitation in three small glacial-till-mantled catchments in the Puget Sound Lowland*, Washington (Water-Resources Investigations Report 96-4219). Tacoma, WA: U.S. Geological Survey.
- Beyerlein, D.C. (1996). *Effective impervious area: The real enemy*. Presented at the Impervious Surface Reduction Research Symposium, The Evergreen State College. Olympia, WA.
- Beyerlein, D.C. (1999). Why standard stormwater mitigation doesn't work. In *Proceedings: Watershed management to protect declining species, American Water Resources Association, Middleburg, VA* (pp. 477-479). Presented at the American Water Resources Association Annual Water Resources Conference, Seattle, WA.
- Bidlake, W.R. & Payne, K.L. (2001). *Estimating recharge to ground water from precipitation at naval submarine base Bangor and vicinity, Kitsap County, Washington* (Water Resources Investigations Report 01-4110). Tacoma, WA: U.S. Geological Survey.
- Blecken, G., Zinger, Y., Deletic, A., Fletcher, T.D., and Viklander, M. (2009). Influence of intermittent wetting and drying conditions on heavy metal removal by stormwater biofilters. *Water Research* 43: 4590-4598.
- Blosser, Mark C. Project Engineer II, Public Works Department, City of Olympia. Personal communication, August 2004.
- Bohnhoff, B. (2001). *Bill Bohnhoff's white papers*. Golden, CO: Invisible Structures, Inc.
- Booth, D.B. (1991). Urbanization and the natural drainage system – Impacts, solutions, and prognoses. *The Northwest Environmental Journal*, 7, 93-118.
- Booth, D.B., Hartley, D., & Jackson, R. (2002, June). Forest cover, impervious-surface area, and the mitigation of stormwater impacts. *Journal of the American Water Resources Association*, 38, 835-845.

- Borgwardt, S. (1997 February). Performance and fields of application for permeable paving systems. *Concrete Precasting Plant and Technology*, pp. 100-104.
- Borgwardt, S. (1994). *Expert Opinion*. Hannover, Germany: University of Hannover, Institute for Planning Green Spaces and for Landscape Architecture.
- Bratieres, K., Fletcher, A., Deletic, A., and Zinger, Y. (2008). Nutrient and sediment removal by stormwater biofilters: A large-scale design optimisation study. *Water Research*, 42, 3930-3940.
- Brattebo, B.O., & Booth, D.B. (2003 November). Long-term stormwater quantity and quality performance of permeable pavement systems. *Water Research*, 37, 4368-4376.
- British Columbia Institute of Technology (BCIT) (2006). BCIT Green Roof Research Program, Phase 1 Summary of Data Analysis: Report to Canada Mortgage and Housing Corporation. Vancouver, B.C: Author
- BuildingSoil.org *Erosion Control with Compost*. http://www.buildingsoil.org/tools/Erosion_Control.pdf
- Burges, S., Fellow, ASCE, Wigmosta, M.S., & Meena, J.M. (1998, April). Hydrological effects of land-use change in a zero-order catchment. *Journal of Hydrologic Engineering*, 3, 86-97.
- Cahill, Thomas, Cahill Associates. Personal communication, April 2003.
- Cahill, T.H., Adams, M., & Marm, C. (2003, September/October). Porous asphalt: The right choice for porous pavements. *Hot Mix Asphalt Technology*. 26-40.
- Cahill Associates. Section 02725 – General porous paving and groundwater infiltration beds. In *General Specification Only: Porous Paving 02725-1*. Specifications received May, 2004 from Cahill Associates. West Chester, PA.
- Calder, I.R. (1990). *Evaporation in the uplands*. Chichester, NY: John Wiley & Sons, Inc.
- Canadian Mortgage and Housing Corporation (CMHC). (2002 July). Residential street pattern design. In *Socio-economic series*. Ottawa, Ontario: Author.
- Center for Housing Innovation. (2000). *Green neighborhoods: Planning and design guidelines for air, water and urban forest quality*. Eugene, OR: University of Oregon.
- Center for Watershed Protection [CWP]. (1995, December). Site planning for urban stream protection. *Environmental Land Planning Series*. Washington, D.C.: MWCG.
- Center for Watershed Protection [CWP]. (1998). *Better site design: A handbook for changing development rules in your community*. Ellicott City, MD: Author.
- Center for Watershed Protection [CWP]. (2000a). Basic concepts in watershed planning. In T.R. Schueler & H.K. Holland (Eds.), *The practice of watershed protection* (pp. 145-161). Ellicott City, MD: Author.
- Center for Watershed Protection [CWP]. (2000b). Comparative pollutant removal capability of stormwater treatment practices. In T.R. Schueler & H.K. Holland (Eds.), *The practice of watershed protection* (pp. 371-376). Ellicott City, MD: Author.

- Center for Watershed Protection [CWP]. (2000a, January). Can urban soil compaction be reversed? *Watershed Protection Techniques*. 3, 666-669.
- Center for Watershed Protection [CWP]. (2000b, January). The compaction of urban soils. *Watershed Protection Techniques*. 3, 661-665.
- Center for Watershed Protection [CWP]. (2000c, January). The impact of stormwater on Puget Sound wetlands. *Watershed Protection Techniques*. 3, 670-675.
- Center for Watershed Protection [CWP]. (2000, March). The dynamics of urban stream channel enlargement. *Watershed Protection Techniques*. 3, 729-734.
- Chapman, C. & Horner, R.R. (2010). Performance assessment of a street-drainage bioretention system. *Water Environment Research*, 82(2), 109-119.
- Chiou, C.T. (2002). *Partition and absorption of organic contaminants in environmental systems*. Hoboken, NJ: Wiley-Interscience.
- Chollak, T. (n.d.). Guidelines for landscaping with compost-amended soils. In CH2M Hill *Soil improvement project: Exploring the alternatives*. Snohomish, County Public Works, Solid Waste Management Division.
- Christensen-Kirsh, K.M. (1996). *Phytoremediation and wastewater effluent disposal: Guidelines for landscape planners and designers*. Unpublished master's project, Department of Landscape Architecture, University of Oregon, Eugene.
- CH2M Hill. (2000). *Soil improvement project: Exploring the alternatives*. Snohomish, WA: Snohomish County Public Works, Solid Waste Management Division.
- CH2M Hill. (2001). *Pierce County low impact development study*. Pierce County, Washington.
- CH2M Hill, Derry, B., Butchart, C., & Graham, P. (2004, January). *Suggested adaptations to BMPs in the Washington Stormwater Management Manual to include benefits of LID techniques*. (Technical Memorandum 3). Olympia, WA: Puget Sound Action Team.
- City of Olympia. (1995). *Impervious surface reduction study: Final report*. Olympia, WA: Public Works Department, Water Resources Program.
- City of Olympia. (2001, October) *Summary of Green Cove Basin development requirements: City of Olympia*. Olympia, WA: Author.
- City of Portland. (2002). Facility-specific operations and maintenance plans. In Chapter 6 of *2002 Stormwater Management Manual*. Portland, OR: Environmental Services.
- City of Portland. (2002). FAR Bonus for Eco-Roofs in the Central City. In Chapter 2 of *2002 Stormwater Management Manual*. Portland, OR: Environmental Services.
- City of Portland Environmental Services. (2002, January). *Ecoroof: Questions & Answers*. Retrieved July, 2004 from http://www.cleanrivers-pdx.org/pdf/eco_questions.pdf

- Clausen, J.C., & Gilbert, J.K. (2003, September). *Annual report: Jordan Cove urban watershed section 319 national monitoring program project*. Storrs-Mansfield, CT: University of Connecticut, College of Agriculture and Natural Resources.
- Coffman, Larry. President, Stormwater Services. Personal communication. 2012.
- Colandini, V., Legret, M., Brosseaud, Y., Balades, J.D. (1995). Metallic pollution in clogging materials of urban porous pavements. *Water Science & Technology*, 32(1), 57-62
- Corish, K. (1995). *Environmental land planning (ELP) series: Clearing and grading strategies for urban watersheds*. Washington, D.C.: Metropolitan Washington Council of Governments.
- Crooks, Rick. Director of Marketing, Mutual Materials. Personal communication, July 2004.
- Cuffney, T.F., Brightbill, R.A., May, J.T., and White, I.R. (2010). Responses of benthic macroinvertebrates to environmental changes associated with urbanization in nine metropolitan areas. *Ecological Applications*, 20, 1384–1401.
- Davis, A.P., Shokouhian, M., Sharma, H., & Minami, C. (1998). *Optimization of bioretention design for water quality and hydrologic characteristics. Final Report*. (Project No. 01-4-31032). Landover, MD: The Prince George's County Government, Department of Environmental Resources.
- Davis, A.P., Shokouhian, M., Sharma, H., & Minami, C. (2001 January/February). Laboratory study of biological retention for urban stormwater management. *Water Environment Research*, 73, 5-14.
- Davis, A.P., Shokouhian, M., Sharma, H., Minami, C., & Winogradoff, D. (2003 January/February). Water quality improvement through bioretention: Lead, copper, and zinc removal. *Water Environment Research*, 75, 73-82.
- Davis, A.P.; Shokouhian, M.; Sharma, H; Minami, C (2006) Water Quality Improvement through Bioretention Media: Nitrogen and Phosphorus Removal, *Water Environment Research* 78(3): 284-293.
- Day, S.D. & Dickinson, S.B. (2008). *Managing Stormwater for Urban Sustainability Using Trees and Structural Soils*. Virginia Polytechnic Institute and State University, Blacksburg, VA.
- DeJong-Hughes, J., Moncrief, J.F., Voorhees, W.B., & Swan, J.B. (2001). *Soil compaction: Causes, effects, and control*. Minneapolis-St. Paul, MN: Regents of the University of Minnesota.
- Delaware Department of Natural Resources and Environmental Control & The Environmental Management Center of the Brandywine Conservancy (1997). *Conservation design for stormwater management: A design approach to reduce stormwater impacts from land development and achieve multiple objectives related to land use*. Dover, DE: Author.
- Dierkes, C., Kuhlmann, L., Kandasamy, J., & Angelis, G. (2002, September). Pollution retention capability and maintenance of permeable pavements. In "Global solutions for urban drainage", *Proceedings of the Ninth International Conference on Urban Drainage*. Portland, OR.
- Dinicola, R.S. (1990). *Characterization and simulation of rainfall-runoff relations for headwater basins in western King and Snohomish Counties, Washington*. (Water-Resources Investigations Report 89-4052). Tacoma, WA: U.S. Geological Survey.

- Diniz, E.V. (1980). *Porous pavement: Phase I – Design and operational criteria* (EPA – 600/2-80-135). Cincinnati, OH: U.S. Environmental Protection Agency, Municipal Environmental Research Laboratory, Office of Research and Development.
- Doucette, W.J., Bugbee, B.G, Smith, S.C., Pajak, C.J., & Ginn, J.S. (2003). In McCutcheon, S.C., & Schnoor, J.L. (Eds.), *Phytoremediation: Transformation and control of contaminants*. (pp. 561-588). Hoboken, NJ: Wiley-Interscience, Inc.
- Dunnett and Kingsbury (2004). *Planting Green Roofs and Living Walls*. Timber Press.
- Dzantor, E.K., & Beauchamp, R.G. (2002 June). Phytoremediation, Part I: Fundamental basis for the use of plants in remediation of organic and metal contamination. *Environmental Practice*, 4, 77-87.
- Ewing, R. (1996). *Best development practices: Doing the right thing and making money at the same time*. Chicago, IL: American Planning Association.
- Ferguson, Bruce K. (2005). *Porous Pavements*. Boca Raton: CRC Press.
- Field, R., Masters, H., & Singer, M. (1982, April). An overview of porous pavement research. *Water Resources Bulletin*, 18, 265-270.
- Florida Concrete and Products Association, Inc. [FCPA]. (n.d.). *Construction of Portland Cement Pervious Pavement*. Orlando, FL: Author.
- Fritoff, A., & Greger, M. (2003). Aquatic and terrestrial plant species with potential to remove heavy metals from stormwater. *International Journal of Phytoremediation*, 5, 211.
- Fwa, T.F., Tan, S.A., & Guwe, Y.K. (1999). Laboratory evaluation of clogging potential of porous asphalt mixtures (Paper No. 99-0087). In *Transportation Research Record: Journal of the Transportation Research Board*. No. 1681, pp. 43-49.
- Gagliano, R. (2012). President Pin Foundations Inc. Personal communication.
- Garland, Mel. Senior Principal, Apex PLLC. Personal communication. March 2, 2004.
- Glasoe, Stuart and Christy, Aimee (2004). *Coastal Urbanization and Microbial Contamination of Shellfish Growing Areas*. Olympia, WA: Puget Sound Action Team.
- Georgia Concrete and Products Association, Inc. (1997 August). *Recommended specifications for Portland Cement Pervious Pavement*. Tucker, GA: Author.
- Gerrits, C., & James, W. (2001). *Restoration of infiltration capacity of permeable pavers*. Master's thesis, University of Guelph. Guelph, Ontario, Canada.
- Gersen, R. Andrew. Representative for Water and Wastewater products. Wm. A. Matzke Co., Inc. Personal communication, July 2004.
- Grabosky, J., and E.F. Gilman. 2004. Measurement and prediction of tree growth reduction from tree planting space design in established parking lots. *J. Arboric.* 30, 154–159.

- Grant, G., Engleback, L., & Nicholson, B. (2003). *Green Roofs: Their existing status and potential for conserving biodiversity in urban areas*. (Research Report No. 498). Northminster House, Peterborough PE1 1UA: English Nature.
- Green Industry Pros.com. (2012). *Green Roof Demand Growing Leaps and Bounds*. July 18, 2012. <http://www.greenindustrypros.com/article/10743694/green-roof-demand-growing-leaps-and-bounds>
- Haffner, T., Bassuk, N., Grabosky, J., and Trowbridge, P. (2007). *Using Porous Asphalt and CU-Structural Soil™*. Cornell University, Ithica, NY.
- Hathaway, J.M., Hunt, W.F, and Jadlocki S. (2009) Indicator Bacteria Removal in Storm Water Best Management Practices in Charlotte, North Carolina. *Journal of Environmental Engineering*, 135 (12) 1275-1285.
- Herrera Environmental Consultants, Inc. (2008). *The Effects of Trees on Stormwater Runoff*. Seattle, WA: Author.
- Herrera Environmental Consultants, Inc. (2011b). *GSI-CALC USER'S MANUAL: GREEN STORMWATER INFRASTRUCTURE SIZING TOOL FOR WESTERN WASHINGTON LOWLANDS*. Seattle, WA: Author.
- Hinman, C. (2007). *Rain Garden Handbook for Western Washington Homeowners*. Puyallup, WA: Washington State University Extension.
- Hinman, C. (2009). *Bioretention Soil Mix Review and Recommendations for Western Washington*. Puyallup, WA: Washington State University Extension.
- Hinman, Curtis (2009). *Flow Control and Water Quality Treatment Performance of a Residential Low Impact Development Pilot Project in Western Washington*. Water Environment Research Foundation [WERF] 04-DEC-11SG.
- Hinman, C. (2011). LID Technical Workshop Series for Puget Sound. Puyallup, WA: Washington State University Extension.
- Hon, G. E.; Seagren, E.; Davis, A. P. (2002, June). *Sustainable Oil and Grease Removal from Stormwater Runoff Hotspots using Bioretention*. Paper for the 74th Annual Conference and Exhibition of the Pennsylvania Water Environment Association. State College, PA.
- Hong, E., Seagren, E.A., & Davis, A.P. (2002, June 23-26). *Sustainable oil and grease removal from stormwater runoff hotspots using bioretention*. Paper presented at PennTec 2002, the 74th Annual Conference and Exhibition of the Pennsylvania Water Environment Association, State College, PA.
- Horner, R., Lim, H., & Burges, S.J. (2002, November). *Hydrologic monitoring of the Seattle Ultra-Urban stormwater management projects* (Water Resources Series Technical Report No. 170). Seattle, WA: University of Washington.
- Horner, R., May, C., Livingston, E., Blaha, D., Scoggins, M., Tims, J. & Maxted, J. (2001). *Structural and non-structural bmps for protecting streams*. Crawfordville, FL: Watershed Management Institute.
- Hossain, M., Scofield, L.A., & Meier, W.R. (1992). Porous pavement for control of highway runoff in Arizona: Performance to date. In *Transportation Research Record No. 1354*, Transportation Research Board, National Research Council, Washington, D.C., pp. 45-54.

- Hunt, W.F., Jarrett, A.R., Smith, J.T., and Sharkey, L.J. (2006). Evaluating Bioretention Hydrology and Nutrient Removal at Three Field Sites in North Carolina. *Journal of Irrigation and Drainage Engineering*, 132 (6).
- Hutchinson, D., Abrams, P., Retzlaff, R., & Liptan, T. (2003, May). *Stormwater monitoring two ecoroofs in Portland, Oregon, USA*. Portland, OR: City of Portland, Bureau of Environmental Services.
- Hutchinson, S.L., Schwab, A.P., & Banks, M.K. (2003). Biodegradation of petroleum hydrocarbons in the rhizosphere. In McCutcheon, S.C., & Schnoor, J.L. (Eds.), *Phytoremediation: Transformation and control of contaminants*. (pp. 355-386). Hoboken, NJ: Wiley-Interscience, Inc.
- Invisible Structures, Inc. (2003). Technical specification – Gravelpave2 porous paving with integrated Geotextile fabric and anchors. Golden, CO: Author.
- Incardona, J. P., Collier, T.K., and Scholz, N.L. (2004). Defects in cardiac function precede morphological abnormalities in fish embryos exposed to polycyclic aromatic hydrocarbons. *Toxicology and Applied Pharmacology*, 196,191-205.
- Jacob, J.S. & Lopez, R. (2009). Is Denser Greener? An Evaluation of Higher Density Development as an Urban Stormwater-Quality Best Management Practice. *Journal of the American Water Resources Association*, 45(3), 687-701.
- Kantz, T. Environmental Biologist, Pierce County (2002, June 17). *Tree survival rates* (Technical memo). Tacoma, WA: Author.
- Kantz, T. Environmental Biologist, Pierce County (2002, August 5). *Reforestation recommendations for LID projects* (Technical memo). Tacoma, WA: Author.
- Kevern, J.T. (2009). Temperature Behavior of Pervious Concrete Systems. *Journal of the Transportation Research Board*, 2098, 94-101.
- Kim, H., Seagren, E.A., & Davis, A.P. (2003, July/August). Engineered bioretention for removal of nitrate from stormwater runoff. *Water Environment Research*, 75, pp. 355-367.
- King County (1998). Chapter 2 - Drainage Plan Submittal. In *Surface water design manual*. Department of Natural Resources. Seattle, WA.
- Kirschbaum, Robin. Professional Engineer HDR. Personal communication. 2011.
- Kolsti, K.F., Burges, S.J., & Jensen, B.W. (1995). *Hydrologic response of residential-scale lawns on till containing various amount of compost amendment*. (Water Resources Series Technical Report No. 147). Seattle, WA: University of Washington.
- Kurtz, T.E. (1996). *Modeling the Hydrologic Response of Lawns on Till With and Without Compost Amendments*. Master's thesis, University of Washington, Seattle.
- Laetz, C.A., Baldwin, D.H., Collier, T.K., Hebert, V., Stark, J.D., and Scholz, N.L. (2008). The synergistic toxicity of pesticide mixtures: implications for ecological risk assessment and the conservation of threatened Pacific salmon. *Environmental Health Perspectives*, in press (doi:10.1289/ehp.0800096 available via <http://dx.doi.org/>).

- Legg, A.D., Bannerman, R.T., & Panuska, J. (1996). *Variation in the relation of rainfall to runoff from residential lawns in Madison, Wisconsin, July and August 1995*. (Water-Resources Investigations Report 96-4194). Madison, WI: U.S. Geological Survey.
- Leigh, M. (Ed.). (1999). *Grow your own native landscape: A guide to identifying, propagating & landscaping with Western Washington native plants*. Olympia, WA: Native Plant Salvage Project, WSU Cooperative Extension – Thurston County.
- Li, H.; Davis, A. (2008) Heavy Metal Capture and Accumulation in Bioretention Media, *Environmental Science and Technology*, 42(14): 5247-5253.
- Lindsey, P. & Bussuk, N. (1992). Redesigning the Urban Forest from the Ground Below: A New Approach to Specifying Adequate Soil Volumes for Street Trees. *Arbicultural Journal* 16, 25-39.
- Low Impact Development Center. (2003). *LID integrated management practices (IMP) standards and specifications*. Retrieved April, 2004, from <http://www.lowimpactdevelopment.org/EPA03.htm#imp>
- Low Impact Development Center. (2012). *LID integrated management practices (IMP) standards and specifications*. <http://www.lowimpactdevelopment.org/>
- Lucas, W.C.; Greenway, M. (2008) Nutrient Retention in Vegetated and Non Vegetated Bioretention Mesocosms. *Journal of Irrigation and Drainage Engineering* 134(5), 613-623.
- Lucas, W. & Greenway, M. (2009). Trends in Nutrient Retention by Bioretention Systems: Long-Term Response to Varied Nutrient Loads. *6th International Water Sensitive Urban Design & Hydropolis* 3.
- Lucas, W. & Greenway, M. (March 12, 2011). Phosphorus Retention by Bioretention Mesocosms Using Media Formulated for Phosphorus Sorption: Response to Accelerated Loads. *Journal of Irrigation and Drainage Engineering*, 137, 144-153.
- Lux, James. Owner, Low Impact Site Development. Personal communication, July 2004.
- MacCoy, D.E. & Black, R.W. (1998). *Organic Compounds and Trace Elements in Freshwater Streambed Sediment and Fish from the Puget Sound Basin*. (USGS Fact Sheet 105-98). Washington D.C.: U.S. Government Printing Office.
- Magnusson Klemencic Associates (MKA) (2007). Seattle Green Roof Evaluation Project. Seattle, WA: Author.
- Marmioli, N., & McCutcheon, S.C. (2003). Making phytoremediation a successful technology. In McCutcheon, S.C., & Schnoor, J.L. (Eds.), *Phytoremediation: Transformation and control of contaminants*. (pp. 85-119). Hoboken, NJ: Wiley-Interscience, Inc.
- Maryland Office of Planning. (1994). Clustering for resource protection. In *Managing Maryland's growth: Models and guidelines. Flexible and innovative zoning series*. Baltimore, MD: Author.
- Matheny, N., & Clark, J.R. (1998). *Trees and development: A technical guide to preservation of trees during land development*. Champaign, IL: International Society of Arboriculture.
- May, C.W., Horner, R.R., Karr, J.R., Mar, B.W. & Welch, E.B. (1997). *The cumulative effects of urbanization on small streams in the Puget Sound lowland ecoregion*. Seattle, WA: University of Washington.

- McCutcheon, S.C., & Schnoor, J.L. (Eds.). (2003). *Phytoremediation: Transformation and Control of Contaminants*. Hoboken, NJ: Wiley-Interscience, Inc.
- McDonald (2008). When to Amend: Construction Sequencing for Soil Protection and Restoration. http://www.buildingsoil.org/tools/When_to_Amend.pdf
- McKinnon, Greg. Operations Manager, Stoneway Concrete. Personal communication, March 2004.
- McPherson, E.G., Simpson, J.R., Peper, P.J., Maco, S.E., Gardner, S.L., Cozad, and S.K., Xiao, Q. (2005). *City of Minneapolis, Minnesota Municipal Tree Resource Analysis*. Technical Report To Forestry Section, Minneapolis Parks and Recreation Board. MI: Minneapolis
- Metro. (2003). *Green streets: Innovative solutions for stormwater and stream crossings*. Portland, OR: Author.
- Miller, C. (2002, July). *Use of vegetated roof covers in runoff management*. Philadelphia, PA: Roofscapes, Inc.
- Miller, C., & Pyke, G. (1999). *Methodology for the design of vegetated roof covers*. Proceedings of the 1999 International Water Resource Engineering Conference ASCE. Seattle, WA.
- Miller, Charlie. P.E. and Principal, Roofscapes, Inc. Personal communication, February 2004.
- Miller, C. (2012). *Extensive Vegetative Roofs*. Whole Building Design Guide (National Institute of Building Sciences). <http://www.wbdg.org/resources/greenroofs.php>
- Municipal Research and Services Center of Washington (MRSC) (1997). *Infill Development – Strategies for Shaping Livable Neighborhoods*. Report #38 (1997, June).
- Murfee, G., Scaief, J.F., & Whelan, M. (1997, July). A Better Best Management Practice. *Water Environment & Technology*, 45-48.
- National Association of Home Builders, American Society of Civil Engineers, Institute of Transportation Engineers, and Urban Land Institute. (2001). *Residential streets* (Third ed.). Washington, D.C.: ULI - the Urban Land Institute.
- Natural Resources Conservation Service. (2001, March). Vegetative barrier (601) Standard. In Section IV of *Washington State Natural Resource Conservation electronic field office technical guide*. Retrieved September, 2004 from <http://efotg.nrcs.usda.gov/treemenuFS.aspx?Fips=53053&MenuName=menuWA.zip>
- Olson, P.E., Reardon, K.F., & Pilon-Smits, E.A.H. (2003). Ecology of rhizosphere bioremediation. In McCutcheon, S.C., & Schnoor, J.L. (Eds.), *Phytoremediation: Transformation and control of contaminants*. (pp. 317-353). Hoboken, NJ: Wiley-Interscience, Inc.
- Palazzi, L. (2002, May). *Assessment of pin foundation impacts on soil characteristics*. Olympia, WA: Pacific Rim Soil & Water, Inc.
- Parisi, Dave A., Paving System Specialist, Mutual Materials. Personal communication, July 2004.
- Peck, S.W., Callaghan, C., Kuhn, M., & Bass, B. (1999). *Greenbacks from green roofs: Forging a new industry in Canada*. Ottawa, Ontario, Canada: Canada Mortgage and Housing Corporation.

- Peck, S., & Kuhn, M. (n.d.). *Design guidelines for green roofs*. Canada Mortgage and Housing Corporation (CMHC). Retrieved July, 2004 from <http://www.cmhc.ca/en/inpr/bude/himu/coedar/loader.cfm?url=/commonspot/security/getfile.cfm&PageID=70146>
- Pentec Environmental. (2000). *BMP – Permeable interlocking concrete pavement*. (Project No. 503-001). Prepared for Mutual Materials, Bellevue, WA.
- Pierce County, Washington Ordinance No. 2003-66, Exhibit “B”, Chapter 10 (“New Chapter”). *Low Impact Development*.
- Pierce County, Washington Ordinance No. 2003-66, Exhibit “I” § 18H.40.040, *Tree Conservation Standards*.
- Pine, Bob. Director of Environmental Planning and Engineering, Pine & Swallow Associates. Personal communication, 2012.
- Pitt, R., Clark, S., Voorhees, J. (1995). *Water Removal in Bioretention Devices by Evapotranspiration Processes and Related Issues Affecting Performance*.
- Pivo, G. & Lidman, R.M. (1990). *Growth in Washington: A chartbook*. Olympia, WA: Washington State Institute for Public Policy, Evergreen State College.
- Pope, Tim. President, Northwest Water Source. Personal communication, August 2004.
- Porous Asphalt Summit (2009). Convened at Washington State University Puyallup, WA.
- Pratt, C.J., Mantle, D.G., & Schofield, P.A. (1989). Urban stormwater reduction and quality improvement through the use of permeable pavements. *Water Science and Technology*, 21, pp. 769-778.
- Pratt, C.J., Newman, A.P., & Bond, P.C. (1999). Mineral oil bio-degradation within a permeable pavement: Long term observations. *Water Science and Technology*, 39, 103-109.
- Prichard, D., Anderson, J., Correll, C., Fogg, J., Gebhardt, K., Krapf, R. et al. (1998, September). *Riparian area management TR-1737-15: A user guide to assessing proper function condition and the supporting science for Lotic Areas* (BLM/RS/ST-98/001+1737). Denver, CO: Bureau of Land Management.
- Prince George’s County. (2002). *Bioretention manual*. Prince George’s County, MD: Department of Environmental Resources, Programs and Planning Division.
- Prince George’s County, Maryland. (2000, January). *Low-impact development design strategies: An integrated design approach*. (US EPA No. 841-B-00-003). Washington, D.C.: U.S. Environmental Protection Agency
- Puget Sound Partnership (2012). *Integrating LID into Local Codes: A Guidebook for Local Governments*. AHBL: Author.
- Puget Sound Water Quality Action Team. (2000, December). *2000 Puget Sound water quality management plan*. Olympia, WA: Author.
- Raskin, I., & Ensley B.D. (2000). *Phytoremediation of toxic metals: Using plants to clean up the environment*. New York, NY: John Wiley & Sons, Inc.

- Robertson C. Geotechnical Engineer, Shannon & Wilson. Personal communication. 2009.
- Rusciano, G.M.; Obrupta, C.C. (2007). Bioretention Column Study: Fecal Coliform and Total Suspended Solids Reductions. *Transactions of the ASABE* 50(4): 1261-1269.
- Sandahl, J.F., Baldwin, D.H., Jenkins, J.J., and Scholz, N.L. (2004). Odor-evoked field potentials as indicators of sublethal neurotoxicity in juvenile coho salmon exposed to copper, chlorpyrifos, or esfenvalerate. *Canadian Journal of Fisheries and Aquatic Sciences*, 61, 404-413.
- Scholz-Barth, K. (2001, January/February). Green roofs: Stormwater management from the top down. *Environmental Design & Construction*, 4 (1).
- Schueler, T., Center for Watershed Protection. (1995). *Environmental land planning series: Site planning for urban stream protection*. (Publication No. 95708). Washington, D.C.: Metropolitan Washington Council of Governments, Department of Environmental Programs.
- Schueler, T.R., & Claytor, R.A. (1996). *Design of stormwater filtering systems*. Ellicott City, MD: The Center for Watershed Protection.
- Seattle Public Utilities. (2000). SEA Street soil preparation specifications. In Project Manual for S.E.A. Streets 2nd Avenue NW. Seattle, WA: Engineering Services Branch.
- Seattle Public Utilities. (2000). Standard Specifications – Section 2-03 roadway excavation and embankment. In *Project Manual for S.E.A. Streets 2nd Avenue NW*. Seattle, WA: Engineering Services Branch.
- Seattle Public Utilities. (2003). Standard Specifications – Section 2-03 roadway excavation and embankment. In *Project Manual for Broadview Greengrid – 4th Avenue NW to Phinney Ave N*. Seattle, WA: Engineering Services Branch.
- Seattle Public Utilities. (2004). *Cost analysis of natural vs. traditional drainage systems meeting NDS stormwater goals*. Seattle, WA: Stormwater Planning Unit.
- Seattle Public Utilities (2009). Resource Efficient Natural Landscaping. http://www.seattle.gov/util/groups/public/@spu/@conservation/documents/webcontent/spu01_003440.pdf
- Seattle Public Utilities (2010). Construction Inspection Checklist for Stormwater Code Compliance. Seattle, WA: http://www.seattle.gov/util/groups/public/@spu/@usm/documents/webcontent/spu02_019968.pdf
- Seattle Public Utilities (2011). Section 8-02.3(6)B. Standard Specifications for Road, Bridge and Municipal Construction. City of Seattle, WA.
- Simmons, R.C. (2001). *Plant it right!: restoring our streams*. Pullman, Washington: Washington State University Extension and Puget Sound Water Quality Action Team.
- Smith, David R., Technical Director, Interlocking Concrete Pavement Institute. Personal communication, July 2004.
- Smith, D.R. (2000). *Permeable interlocking concrete pavements: Selection, design, construction, maintenance*. Washington, D.C.: Interlocking Concrete Pavement Institute.

- Smith, D. (2011). *Permeable Interlocking Concrete Pavements: Design, Specifications, Construction, Maintenance*. 4th Edition. Herndon, VA.
- Sound Native Plants. (2000). *Relative success of transplanted/outplanted plants*. Olympia, WA: Author.
- Spadoni, Leonard. Estimator/Job Superintendent. Tucci & Sons, Inc. Personal communication, April 2004.
- Staubitz, W.W., Bortleson, G.C., Semans, S.D., Tesoriero, A.M., & Black, R.W. (1997). *Water-quality assessment of the Puget Sound Basin, Washington, environmental setting and its implications for water quality and aquatic biota*. (Water-Resources Investigations Rep. 97-4013). Denver CO: U.S. Geological Survey.
- Stenn, H. (2003). *Guidelines and resources for implementing soil depth and quality BMP T.5.13 in WDO Western Washington Stormwater Manual*. Snohomish, WA: Snohomish County Public Works.
- Stern, K.R. (2000). *Introductory Plant Biology*. (8th ed.). Boston, MA: McGraw Hill.
- St. John, M. (1997). *Porous asphalt road shoulders: Effect of road sanding operations and their projected life span*. Renton, WA: King County Department of Transportation.
- St. John, M.S., & Horner, R.R. (1997). *Effect of road shoulder treatments on highway runoff quality and quantity*. Seattle, WA: Washington State Transportation Center (TRAC).
- Stuart, D. (2001). *On-site runoff mitigation with rooftop rainwater collection and use*. Seattle, WA: King County Department of Natural Resources, Water and Land Resources Division.
- Subramanian, M., & Shanks, J.V. (2003). Role of plants in the transformation of explosives. In McCutcheon, S.C., & Schnoor, J.L. (Eds.), *Phytoremediation: Transformation and control of contaminants*. (pp. 389-408). Hoboken, NJ: Wiley-Interscience, Inc.
- Sun, X.; Davis, A.P. (2007) Heavy metal fates in laboratory bioretention systems, *Chemosphere* 66: 1601-1609.
- Tackett, T. (2004, March). *Seattle's soil strategies for stormwater goals*. (Work in progress). Seattle, WA: Seattle Public Utilities.
- Tackett, Tracy. Professional engineer. Seattle Public Utilities, Drainage. Personal communication, March 2004.
- Taylor, B.T. (1993). *The influence of wetland and watershed morphological characteristics on wetland hydrology and relationships to wetland vegetation communities*. Master's thesis, University of Washington, Seattle.
- Texas Water Development Board. (1997). *Texas guide to rainwater harvesting* (2nd ed.). Austin, TX: Author.
- Texas Water Development Board. (2005). *Texas Guide to Rainwater Harvesting* (3rd ed.). Austin, TX: Author.
- Uni-Group USA (2002). *UNI ECO-STONE Guide and Research Summary: Permeable Pavement for Stormwater Management*. Palm Beach Gardens, FL.
- Urban, J. (2008). *Up by Roots: Healthy Soils and Trees in the Built Environment*. International Society of Arboriculture.

- U.S. Army Corps of Engineers. (2003). Section 02726: Portland cement pervious pavement. In *Whole Barracks Renewal*, Fort Lewis, WA (02022/DB-CS). Fort Lewis, WA: Author.
- U.S. Army Environmental Center and Fort Lewis. (2003, October 28-30). *Low impact development workshop*. Workshop conducted at Fort Lewis, Washington.
- U.S. Code of Federal Regulations. 36 CFR 1190 (2003). Minimum Guidelines and Requirements for Accessible Design. United States Code of Federal Regulations.
- U.S. Composting Council. (1997). *Test Methods for the Examination of Composting and Compost* (TMECC). <http://compostingcouncil.org/admin/wp-content/plugins/wp-pdfupload/pdf/34/TMECC%20Purpose,%20Composting%20Process.pdf>
- US Composting Council (2005). <http://compostingcouncil.org/>
- U.S. Environmental Protection Agency [US EPA]. (2000). *Introduction to phytoremediation*. (Publication No. 600/R-99/107). Cincinnati, OH: Author.
- U.S. Environmental Protection Agency [US EPA]. (2000a, October). *Bioretention application: Inglewood demonstration project, Largo, Maryland; Florida Aquarium, Tampa, Florida*. (EPA-841-B-00-005A). Washington, DC: Office of Water.
- U.S. Environmental Protection Agency [US EPA]. (2000b, October). *Vegetated roof cover: Philadelphia, Pennsylvania*. (EPA-841-B-00-005D). Washington, D.C.: Office of Water.
- U.S. Environmental Protection Agency [US EPA]. (2006). *Protecting Water Resources with Higher-Density Development*. Washington, D.C.: Office of Water
- U.S. Environmental Protection Agency (2012). *National Menu of Stormwater Best Management Practices*. <http://cfpub.epa.gov/hpdes/stormwater/menuofbmps/index.cfm>
- WAC 51-40-110. (2003). Building Code Council, Chapter 11 – Accessibility. *Washington Administrative Code*, Olympia, WA.
- Washington Department of Ecology [Ecology]. (2009, October). *Focus on Rainwater Interpretive Policy*. (Publication no. 09-11-026). Olympia, WA: Author.
- Washington Department of Fish and Wildlife (1995). *Restoring the Watershed: A Citizen's Guide to Riparian Restoration in Western Washington*. Olympia, WA: Author.
- Washington Department of Fish and Wildlife (2000). *Integrated Streambank Protection Guidelines*. Olympia, WA: Author.
- Washington Organic Recycling Council (WORC). (2003, February/March). *New soil strategies for stormwater management: Implementing the post-construction soil quality and depth BMPs*. Workshop conducted at the Washington State University Research and Extension Center, Puyallup, Washington.

- Washington State Department of Community, Trade and Economic Development. (2003, November). *Critical areas assistance handbook: Protecting critical areas with the framework of the Washington Growth Management Act*. Olympia, WA: Growth Management Services.
- Washington (State). Office of Community Development, Washington (State). Growth Management Services (2002). Citations of Recommended Sources of Best Available Science for Designating and Protecting Critical Areas. Washington State Office of Community Development.
- Washington State Department of Ecology [Ecology]. (1993, May). *Slope stabilization and erosion control using vegetation, A manual of practice for coastal property owners*. (Publication No. 93-03). Olympia, WA: Author.
- Washington State Department of Ecology [Ecology]. (1995, June). *Surface water and groundwater on coastal bluffs: A guide for Puget Sound property owners*. (Publication No. 95-107). Olympia, WA: Author.
- Washington State Department of Ecology [Ecology]. (2001, August). *Stormwater management manual for Western Washington* (Publication Numbers 99-11 through 99-15). Olympia, WA: Water Quality Program.
- Washington Department of Planning and Development CAM 531 (2009). *Green Stormwater Infrastructure on Private Property: Post Construction Soil Management*. Seattle, WA: Department of Planning and Development. <http://www.seattle.gov/DPD/Publications/CAM/cam531.pdf>
- Washington State Department of Transportation [WSDOT]. (2003, September). *Low impact development (LID) project: Permeable surfaces* (WADOT Permeable Pavement Specs 10-03.doc). Olympia: WA: Author.
- Webb, Chris. President, Chris Webb & Associates. Personal communication. 2005.
- Wei, I.W. (1986). *Installation and evaluation of permeable pavement at Walden Pond State Reservation – Final report*. Report to the Commonwealth of Massachusetts, Division of Water Pollution Control (Research Project 77-12 & 80-22). Boston, MA: Northeastern University, Department of Civil Engineering.
- Wigmosta, M.S., Burges, S.J., & Meena, J.M. (1994). *Modeling and monitoring to predict spatial and temporal hydrologic characteristics in small catchments*. (Water Resource Series Technical Report No. 137). Seattle, WA: University of Washington.
- Wingerter, R., & Paine, J.E. (1989). *Field performance investigation: Portland Cement Pervious Pavement*. Orlando, FL: Florida Concrete and Products Association.
- Winogradoff, Derek A. Project Manager, Prince George's County, Maryland. Personal communication, August 18, 2004.
- West, Larry. Registered Geologist, SLR International Corporation. Personal communication, January 23, 2004.
- World Forestry Center & Morgan, R. (1989). *A technical guide to community and urban forestry in Washington, Oregon and California*. Portland, OR: World Forestry Center.
- World Forestry Center & Morgan, R. (1993). *A technical guide to urban and community forestry*. Portland, OR: World Forestry Center.

- Wullschleger, S.D., Wilson, K.B., and Hanson, P.J. (2000). Environmental control of whole-plant transpiration, canopy conductance and estimates of the decoupling coefficient for large red maple trees. *Agricultural and Forest Meteorology* 104, 157-168.
- Xiao, Q., McPherson, E.G., Ustin, S.L., Grismer, M.E., and Simpson, J.R. (2000). Winter rainfall interception by two mature open-grown trees in Davis, California. *Hydrological Processes* 14, 763-784.
- Zhang, W; Brown, G.O.; Storm, D.E.; Zhang, H. (2008) Fly-Ash-Amended Sand as Filter Media in Bioretention Cells to Improve Phosphorus Removal. *Water Environment Research* 80(6), 507-516.

THIS PAGE
INTENTIONALLY
LEFT BLANK

WASHINGTON STATE UNIVERSITY
 EXTENSION

PugetSoundPartnership

LEADING PUGET SOUND RECOVERY